

SETTING MANUAL (full)

With installation instructions
(For authorized service personnel only)

UTY-TFSXJ3 (AP-WJ3E)
UTY-TFSXJ4 (AP-WJ4E)

Before using this product, read these instructions thoroughly.

This product is a WLAN adapter to connect an air conditioner to the following web service.

- **AIRSTAGE Mobile** (For residential use)
You can operate air conditioners with your smartphone.
* Downloading the mobile app "AIRSTAGE Mobile" is required.

Contents

1. SAFETY PRECAUTIONS	3
2. USAGE PRECAUTIONS	4
3. WIRELESS LAN USAGE PRECAUTIONS	5
3.1. Radio Wave Usage Precautions.....	5
3.2. Personal Information (Security-related) Usage Precautions	6
3.3. Others	6
4. INITIALIZATION (RESET).....	7
5. OPERATION TIPS.....	8
6. SPECIFICATIONS.....	8
7. TROUBLESHOOTING.....	9
8. WLAN ADAPTER SETTINGS (detailed procedure)	
* for authorized service personnel only	12
8.1. Before installing the WLAN adapter.....	12
8.2. Installation work.....	15

Name of Parts

WLAN adapter

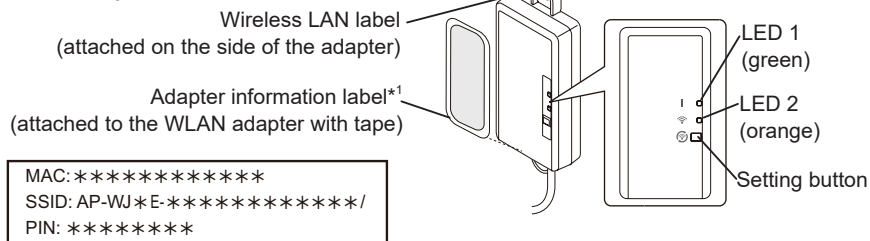

*1) Take off the adapter information label before the installation.

Accessories

The following installation accessories are supplied.

Name and Shape	Qty	Name and Shape	Qty
Setting manual (simple)	1	WLAN adapter with cable	1
"ONLINE MANUALS and WEB APP" sheet	1	Self-tapping screw (M4, 25 mm)	2
Adapter information label (attached to the WLAN adapter with tape)	1	EMI core*2	1



*2) It may not be used depending on the air conditioner. For details on the usage in the installation procedure, refer to the indoor unit installation manual.

NOTE

- The wireless LAN label attached to the WLAN adapter is necessary for wireless LAN setup.

1. SAFETY PRECAUTIONS

- ◆ To prevent personal injury or property damage, read this section carefully before you use this product, and be sure to comply with the following safety precautions.
- ◆ Incorrect operation due to failure to follow the instructions may cause harm or damage, the seriousness of which is classified as follows:

 WARNING	This mark indicates procedures which, if improperly performed, might lead to the death or serious injury of the user.
 CAUTION	This mark indicates procedures which, if improperly performed, might possibly result in personal harm to the user or damage to property.

 This mark denotes an action that is PROHIBITED .	 This mark denotes an action that is COMPULSORY .
--	---

WARNING



- This product contains no user-serviceable parts. Always consult authorized service personnel for repairing, installation, or relocation of this product. Improper handling will cause electric shock or fire.
- In the event of a malfunction such as burning smell, immediately stop the operation of the air conditioner and disconnect all the power supply by turning off the electrical breaker or disconnecting the power plug. Then consult authorized service personnel.



- Do not repair, disassemble, or remodel this product.
- Do not get this product wet or use it in locations with lots of moisture.
- Do not operate with wet hands.
- Do not install this product in locations where the use of wireless equipment is prohibited (e.g. hospitals).
- Do not use this product near persons with a pacemaker or similar devices.
- Do not use this product near automatic control equipment (e.g. automatic doors and fire alarms).

CAUTION



- Disconnect all the power supply when you are not using this product for extended periods.



- Do not press the buttons of this product any more strongly than is necessary.

2. USAGE PRECAUTIONS

- When you use this product, it becomes possible to operate the air conditioner from locations where you cannot see it directly. This means that people in the room may be exposed to the unintended operation of the air conditioner. Check the condition of the room before using this product.
 - **Be sure to check regularly that the power supply to the air conditioner is securely connected and that dust has not built up in the surrounding area.**
It may cause heating or fire.
 - **Be sure to check in advance that there are no malfunctions of the air conditioner.**
 - **Make sure that the airflow from the air conditioner will not cause any adverse effects.**
Objects may fall down causing personal injury, fire, or damage to property.
 - **If you know that there are people in the vicinity of the air conditioner, inform them in advance that you will operate it from a distant location.**
Sudden operation of the air conditioner may surprise a person and cause the person to fall down or tumble if the person is on a step, ladder, etc. Furthermore, rapid changes in the room temperature may cause deterioration in a person's physical condition. Do not use this product when there are people in the room who are not able to control the temperature by themselves (For example, infants, children, those with physical disabilities, elderly, or sick persons.).
 - **Fully understand the reserved timer settings and other operations before using this product.**
Unexpected operation of the air conditioner may cause deterioration in a person's physical condition or an adverse effect on animals or plants.
 - **Frequently check the settings and operating situation of the air conditioner when using this product from a distant location.**
Rapid changes in the room temperature may cause deterioration in a person's physical condition or an adverse effect on animals or plants.
- If you operate the air conditioner from this product, the indicator lamps and reception sounds of the air conditioner do not work.
- If there is bad reception between this product and the access point, adjusting the access point position or direction of the antenna may improve the reception. It may also be possible to improve reception by moving the access point closer to this product or using a wireless LAN repeater.

3. WIRELESS LAN USAGE PRECAUTIONS

When you use a wireless LAN, there are precautions that you must follow in relation to radio waves, personal information, and so on. To use this product correctly, be sure to read the following precautions and the operation manual of the wireless LAN equipment you are using. We will assume no responsibility, unless legal liability is recognized, in regards to failures, other defects, and damages incurred by use of this product that occurs through incorrect use or during use by yourself or a third party.

3.1. Radio Wave Usage Precautions

CAUTION

Changes or modifications not expressly approved by the party responsible for compliance could void the user's authority to operate the equipment.

This transmitter must not be co-located or operated in conjunction with any other antenna or transmitter.

This equipment complies with FCC/IC radiation exposure limits set forth for an uncontrolled environment and meets the FCC radio frequency (RF) Exposure Guidelines and RSS-102 of the IC radio frequency (RF) Exposure rules. This equipment should be installed and operated keeping the radiator at least 20 cm or more away from a person's body. (UTY-TFSXJ3 [AP-WJ3E]/UTY-TFSXJ4 [AP-WJ4E] model conforms to IC [Industry Canada] standard.)

NOTES

This device complies with Part 15 of FCC Rules and Industry Canada license-exempt RSS standard(s).

Operation is subject to the following two conditions:

- (1) this device may not cause interference, and
- (2) this device must accept any interference, including interference that may cause undesired operation of this device.

(UTY-TFSXJ3 [AP-WJ3E]/UTY-TFSXJ4 [AP-WJ4E] model conforms to IC [Industry Canada] standard.)

This equipment has been tested and found to comply with the limits for a Class B digital device, pursuant to part 15 of the FCC Rules.

- Do not use this product in the following locations. Using this product in such locations may cause communications to become unstable or not possible.
 - Near wireless communication equipment that uses the same frequency band (2.4 GHz) as this product.
 - Places where there are magnetic fields from equipment such as microwave ovens, or static electricity or radio wave interference occurs.
(Radio waves may not reach depending on the environment.)

3.2. Personal Information (Security-related) Usage Precautions

- There is a possibility of interception if you use wireless LAN equipment due to the use of radio waves regardless of whether you use encryption or not.
- Wireless LAN uses radio waves to exchange information between this product and the access point. This means it has the advantage of freely being able to make a LAN connection if within reach of radio waves. On the other hand, if the radio waves are within a certain range, they will reach all locations beyond obstacles (e.g., walls). Therefore, it is possible your communications may be intercepted and read or illegally intruded upon.
- Do not connect to equipment and networks which you are not authorized to use when setting up your wireless connection.
- Initialize the settings of this product when disposing of it or transferring it to a third party.

3.3. Others

- Use this product as regular wireless LAN equipment.
 - Do not use this product in hospitals or in/near locations with medical equipment.
 - Do not use this product within an aircraft.
 - Do not use this product near electronic equipment that handles high-precision control or weak signals.
- Examples of electronic equipment to be careful of:
Hearing aids, pacemakers, fire alarms, automatic doors, and other automatic control equipment
- This is not a guarantee of wireless connection and performance with all access points and in all residential environments. Radio waves may not reach or may be interrupted in the following situations.
 - Use in buildings made from concrete, rebars, or metal
 - Installation near obstacles
 - Interference with wireless communication equipment using the same frequency
 - Places where there are magnetic fields from equipment such as microwave ovens, or static electricity or radio wave interference occurs
 - Install and set up this product only after reading the operation manual of the access point.

4. INITIALIZATION (RESET)

Initialize (reset) this product in the following situations:

- Changing the access point
- Disposing of this product
- Transferring this product to a third party

1 Unregister the air conditioner from the mobile app.

For details, refer to the operation manual for [AIRSTAGE Mobile](#).

2 Initialize (reset) this WLAN adapter as the following procedure.

*Lighting pattern: ○ Off ● On ☀ Blinking

(1) Press and hold the Setting button for 12 seconds.

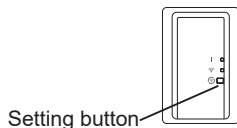

(2) All LED lamps blink 3 times simultaneously (on/off at 0.5-second intervals).

Release the Setting button during the blinking.

The initialization is complete, and LED 1 blinks. (on/off = 2 s/0.5 s)

After 10 seconds, the LED1 turns on (stop blinking).

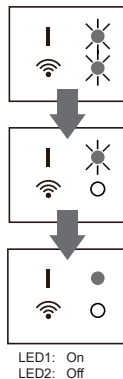

■ To continue to use

If you or a third party wishes to continue the use of this product, connect this product to another access point.

NOTE

- If you initialize the WLAN adapter, the information saved in the WLAN adapter is deleted.

5. OPERATION TIPS

- To operate the air conditioner, refer to the operation manual for [AIRSTAGE Mobile](#).
- The settings from the mobile app are not reflected in the wireless remote controller.
- You cannot operate and monitor the air conditioner from the mobile app while the power supply of the air conditioner is disconnected (via breaker or plug).
- The room temperature is displayed on the mobile app. However, the displayed room temperature may not be correct depending on the situation in the room or the air conditioner's operating status. Use this only as a reference.
- If the settings from the mobile app and the remote controller differ, the air conditioner follows the latest operation.
- If the timer settings are done from the mobile app and the wireless or wired remote controller, both timer settings become active.

6. SPECIFICATIONS

Wireless LAN-compatible standard	IEEE802.11b/g/n
Frequency bands	2.4GHz (in the U.S. or Canada: 1ch~11ch) (in the other regions: 1ch~13ch)
Maximum radio-frequency power	40mW
Wireless LAN security	Open WEP WPA (PSK) WPA2_Personal (PSK) WPS for same-LAN Registration
Operating temperature	0 - 46 °C (32 - 114 °F)

This product includes Open Source Softwares (OSS). To check the included OSS and its licenses, access the following URL.

www.fujitsu-general.com/data/oss/gen3wla/index.html

<For users in EU member states>

For the full text of the following EU declaration of conformity, refer to the following website.

www.fujitsu-general.com/global/support/

SIMPLIFIED EU DECLARATION OF CONFORMITY

The simplified EU declaration of conformity referred to in Article 10 (9) shall be provided as follows: Hereby, FUJITSU GENERAL LIMITED declares that the radio equipment type UTY-TFSXJ3 (AP-WJ3E)/UTY-TFSXJ4 (AP-WJ4E) complies with Directive 2014/53/EU.

7. TROUBLESHOOTING

Check the following items before requesting repairs to this product.

NOTES

- If the problem persists even after performing these checks or diagnostics, consult authorized service personnel.

Parts/Elements	Situation	Solutions
Downloading or account registration of the mobile app	I do not know how to download the mobile app	Refer to "8.2. Installation work".
	The mobile app does not work	Check that the version of the OS on your smartphone is supported. Refer to "Items to Check" of "8.2. Installation work".
	I have not received the e-mail when registering my account	Set the domain permissions so that it is not rejected as spam.
Wireless LAN setup and initial settings	Wireless LAN setup is not possible (The connection settings of the WLAN adapter and the access point are not complete)	Confirm that the access point supports "IEEE802.11b/g/n". Confirm that your access point supports "WPS function" (Button mode). (Check with the operation manual of the access point.)
		Confirm that the indoor unit is connected to the power supply.
		Confirm that the WLAN adapter of the indoor unit is on. (The LED of the WLAN adapter is lit or blinking.)
		Check if there was any previous owner using this wireless LAN control. If there was a previous owner, contact authorized service personnel.
I cannot register the WLAN adapter to the mobile app	Confirm that the LED 1 on the WLAN adapter is on. If it is blinking or off, reconnect the WLAN adapter and the access point.	

Parts/Elements	Situation	Solutions
Operations from the mobile app	I am not able to operate the air conditioner from the mobile app	Confirm that the indoor unit is connected to the power supply.
		Confirm that the power to the access point is on.
		Check that your smartphone is not in flight mode.
		Confirm that your smartphone and the WLAN adapter are connected to the access point.
		Disconnect the air conditioner from the power supply, then reconnect it. Wait for about 15 minutes and try the operation from the mobile app again.

■ State of the Wireless LAN indicators

*Lighting pattern: ○ Off ● On  Blinking

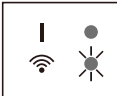
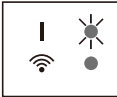
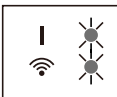
State of the Lamps		Causes and Solutions
All the lamps are off		<p>The power to the WLAN adapter is not on.</p> <p>→ Check that the power to the air conditioner is on and that the air conditioner breaker is not tripped.</p>
LED 2 is off or blinking fast (Repeating 0.5 seconds on / 0.5 seconds off)		<p>The power to the access point is not on.</p> <p>→ Confirm that the power to the access point is on.</p> <p>There is a possibility that the WLAN adapter is not properly connected to the access point.</p> <p>→ Disconnect the power supply to the air conditioner (via breaker or plug), and then re-connect.</p>
LED 1 is blinking fast (Repeating 0.5 seconds on / 0.5 seconds off)		<p>It is not possible to communicate with the air conditioner.</p> <p>→ If the blinking continues for more than a few minutes, there may be a wiring error in the air conditioner. Contact authorized service personnel.</p>
All the lamps are blinking fast (Repeating 0.5 seconds on / 0.5 seconds off)		<p>There is a problem with the WLAN adapter.</p> <p>→ Disconnect the power supply to the air conditioner (via breaker or plug), and then re-connect. Set up the wireless LAN again according to the operation manual for AIRSTAGE Mobile.</p>

8. WLAN ADAPTER SETTINGS (detailed procedure) * for authorized service personnel only

8.1. Before installing the WLAN adapter

WARNING

- For the air conditioner to operate satisfactorily, follow the procedures described in this manual and the [operation manual of the air conditioner](#).
- Installation work must be performed following the national wiring standards by authorized personnel only.

CAUTION

- Install the WLAN adapter near the access point. (The connection may become unstable if it is placed further away, which will make using the system more difficult.)
- Certain types of wall materials may shut out wireless communications.
- Do not touch the heat exchanger.
- During installation or removal, do not have the wire caught by any parts nor pull it hard. It may result in a malfunction of the air conditioner.
- Do not bundle the WLAN adapter wiring with the connection cable running between the indoor and outdoor units, or the power supply cable.
- Install the WLAN adapter between the indoor unit and the access point.
- Do not install the WLAN adapter in the following places, otherwise, radio communication may be interfered with.
 - Places exposed to direct sunlight
 - Places subject to extremely high and low temperatures, such as near the outlet port of the air conditioner main body
 - Near the air conditioner air inlet or outlet
 - Places with high humidity
 - Places near moving parts of the air conditioner main body
 - Places near the bottom of the air conditioner main body
 - Inside or on the side of the air conditioner main body
 - Near microwave ovens
 - Within 1 m (40 in) of a TV or radio
 - Places in the reach of children
 - Near automatic control devices such as automatic door sensors or fire detectors
 - Places with oil, vapour, or flammable gases
 - Near medical equipment, pacemakers, defibrillators, or other devices
 - Places where the WLAN adapter could get wet, such as in the bathroom
 - Places where the WLAN adapter is difficult to access for maintenance
- Do not lay the WLAN adapter cable or LAN cable on the floor. You may trip on the cables.
- Install the WLAN adapter in a place where you can operate the switches and buttons and confirm the indicator lamps. (In the areas shown below.)

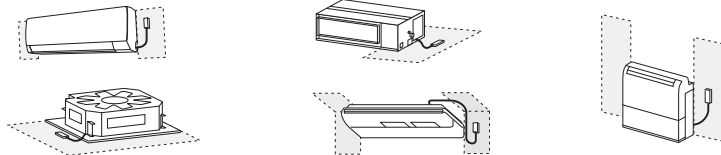

8.1.1 System diagram

One WLAN adapter can be connected to each indoor unit.

Single connection

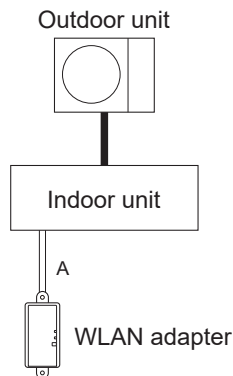

Multi-split connection

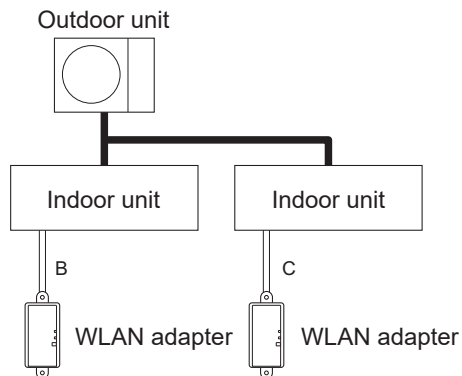

A, B, and C are adapter cables attached to this product.

Prohibited uses:

(1) Group connection of indoor units with wired remote controller

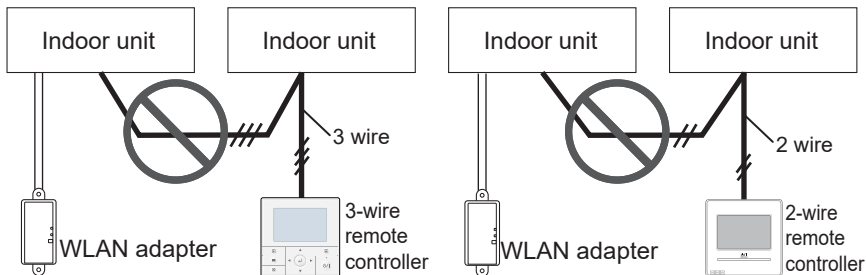

(2) Group connection of indoor units

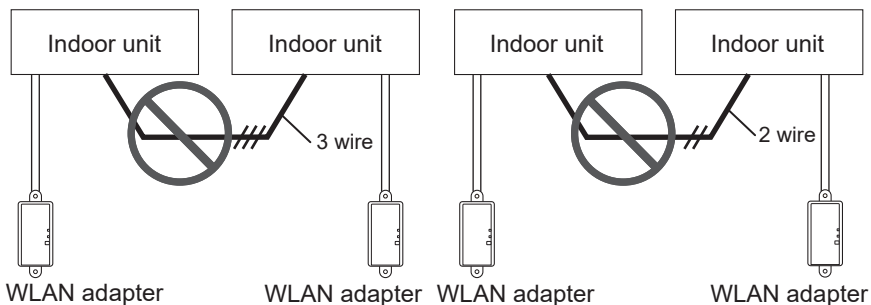

(3) Group connection of indoor units with WLAN adapter cable.

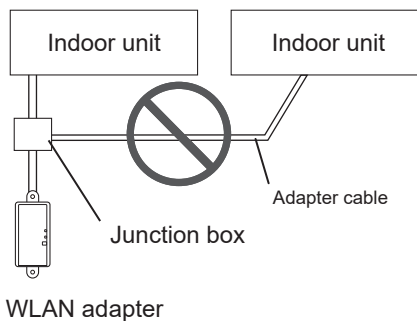

(4) Extended wiring
Extending the cable is prohibited.

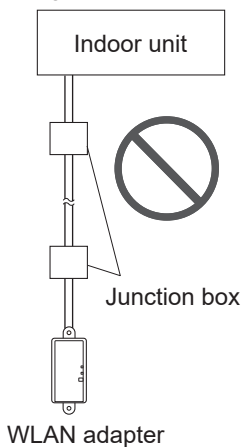

8.2. Installation work

WARNING

- Disconnect the power supply or turn off the breaker before starting work. Failure to disconnect the power supply may lead to electric shock or fire.
- Do not turn on the power until all installation work is complete.
- Use the accessories or specified connection cables.
Do not modify connection cables other than those specified, do not use extension cords, and do not use independent branch wiring. The allowable current will be exceeded and cause electric shock or fire.
- When installing this product, make sure that there are no children nearby. Otherwise, injury or electric shock could result.

CAUTION

- Discharge static electricity on your body before starting work. If static electricity is not discharged, there is a risk that the board parts may be damaged.
- When performing wiring work, be careful not to damage the cable or injure yourself. Also, connect the connectors securely. Loose connectors will cause trouble, heating, fire, or electric shock.
- Perform wiring so that water does not enter this unit along the external wiring. Always install a trap to the wiring or take other countermeasures. Otherwise it will cause trouble or electric shock or fire.
- Do not touch the circuit board and circuit board parts directly with your hands. Otherwise, injury or electric shock could result.

This manual indicates the procedure to install and set up the WLAN adapter.
In addition, we provide online content on our website.

Product information page for AIRSTAGE Mobile

This web page instructs the feature of AIRSTAGE Mobile and the URLs for downloading the mobile app.

www.fujitsu-general.com/global/products/airstagemobile/index.html

Items to Check

* Prepare the following items before using this product.

Access point	<p>It should support IEEE802.11b/g/n wireless LAN standard and have a DNS server function.</p> <p>Set the connection to the access point with WPS to perform communications by wireless LAN.</p> <p>Refer to the operation manual of the access point to check if it supports these conditions.</p> <p>* When you use AIRSTAGE Mobile only in Direct Control mode, the access point is unnecessary.</p>	
AIRSTAGE Mobile	Be sure to update and keep it the latest version.	
Smartphone	<p>Supported OS:</p> <ul style="list-style-type: none"> • Android OS • iOS 	Check the latest supported OS version at Google Play or App Store.

“AIRSTAGE Mobile” is a trademark of FUJITSU GENERAL LIMITED.

Android and Google Play are registered trademarks of Google LLC.

App Store is a service mark of Apple Inc., registered in the U.S. and other countries.

iOS is a trademark or registered trademark of Cisco in the U.S. and other countries and is used under license.

1 Connect the wire.

For the connection details, refer to the installation manual for the indoor unit. Attach the connector directly to the printed circuit board (PCB).

NOTE: Options connecting to CN65 cannot be used at the same time.

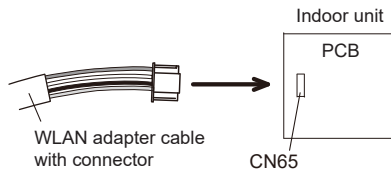

2 Install the WLAN adapter.

Install the WLAN adapter in the direction as shown in the figure.

If the WLAN adapter is installed in the wrong direction, water may get into the adapter through the wire, causing failure.

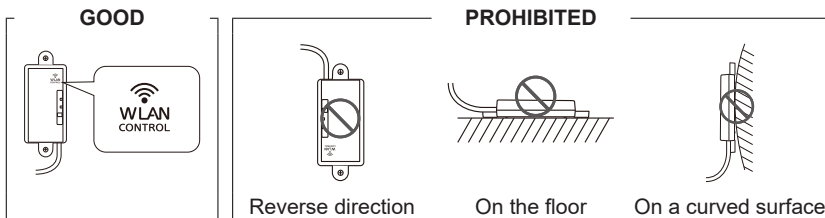
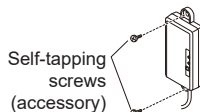

Do not lay the WLAN adapter cable on the floor. You may trip on the cables.

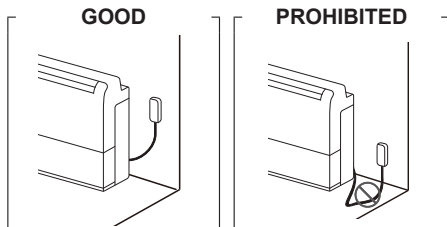

3 Connect the indoor unit to the power supply.

Wait until the LED 1 stops the blinking (LED1: on, LED 2: on). It takes about 10 seconds.



4 Connect the WLAN adapter and the access point.

Refer to the operation manual of [AIRSTAGE Mobile](#) for details.

CAN ICES-3 (B)/NMB-3(B)

TRA REGISTERED No. ER02774/21
DEALER No. DA77717/18



FUJITSU GENERAL LIMITED

3-3-17, Suenaga, Takatsu-ku, Kawasaki 213-8502, Japan