

AIR CONDITIONER

Wall mounted type

DESIGN & TECHNICAL MANUAL

INDOOR



ASYG09KHCA
ASYG12KHCA
ASYG14KHCA

OUTDOOR



AOYG09KHCAN
AOYG12KHCAN
AOYG14KHCAN

FUJITSU GENERAL LIMITED

Notices:

- Product specifications and design are subject to change without notice for future improvement.
- For further details, please check with our authorized dealer.

Trademarks

FGLair™ is trademark of Fujitsu General Limited in the United States, other countries or both.

Google Play™ is trademark of Google Inc.

App Store® is a service mark of Apple Inc., registered in the U.S. and other countries.

CONTENTS

Part 1. INDOOR UNIT	1
1. Specifications	2
2. Dimensions	5
2-1. Models: ASYG09KHCA, ASYG12KHCA, and ASYG14KHCA.....	5
3. Wiring diagrams	7
3-1. Models: ASYG09KHCA, ASYG12KHCA, and ASYG14KHCA.....	7
4. Capacity table	8
4-1. Cooling capacity.....	8
4-2. Heating capacity.....	9
5. Fan performance	10
5-1. Air velocity distributions.....	10
5-2. Airflow.....	12
6. Operation noise (sound pressure)	14
6-1. Noise level curve.....	14
6-2. Sound level check point.....	15
7. Safety devices	16
8. External input and output	17
8-1. External input.....	17
8-2. External output.....	20
9. Group connection	22
10. Remote controller	23
10-1. Wireless remote controller.....	23
11. Function settings	25
11-1. Function settings by using remote controller.....	25
11-2. Custom code setting for wireless remote controller.....	29
12. Accessories	30
12-1. Models: ASYG09KHCA, ASYG12KHCA, and ASYG14KHCA.....	30
13. Optional parts	31
13-1. Controllers.....	31
13-2. Others.....	31

CONTENTS (continued)

Part 2. OUTDOOR UNIT	33
1. Specifications	34
2. Dimensions	35
2-1. Models: AOYG09KHCCAN, AOYG12KHCCAN, and AOYG14KHCCAN	35
3. Installation space	36
3-1. Models: AOYG09KHCCAN, AOYG12KHCCAN, and AOYG14KHCCAN	36
4. Refrigerant circuit	39
4-1. Models: AOYG09KHCCAN, AOYG12KHCCAN, and AOYG14KHCCAN	39
5. Wiring diagrams	40
5-1. Models: AOYG09KHCCAN, AOYG12KHCCAN, and AOYG14KHCCAN	40
6. Capacity compensation rate for pipe length and height difference	41
6-1. Model: AOYG09KHCCAN	41
6-2. Model: AOYG12KHCCAN	42
6-3. Model: AOYG14KHCCAN	42
7. Additional charge calculation	43
7-1. Models: AOYG09KHCCAN, AOYG12KHCCAN, and AOYG14KHCCAN	43
8. Airflow	44
8-1. Model: AOYG09KHCCAN	44
8-2. Model: AOYG12KHCCAN	44
8-3. Model: AOYG14KHCCAN	44
9. Operation noise (sound pressure)	45
9-1. Noise level curve.....	45
9-2. Sound level check point	46
10. Electrical characteristics	47
11. Safety devices	48
12. Accessories	49
12-1. Models: AOYG09KHCCAN, AOYG12KHCCAN, and AOYG14KHCCAN	49

Part 1. INDOOR UNIT

WALL MOUNTED TYPE:

ASYG09KHCA

ASYG12KHCA

ASYG14KHCA

1. Specifications

Type				Wall mounted			
				Inverter heat pump			
Model name				ASYG09KHCA	ASYG12KHCA	ASYG14KHCA	
Power supply				230 V ~ 50 Hz			
Power supply intake				Outdoor unit			
Available voltage range				198—264 V			
Energy rank				1			
Capacity	Cooling	Rated	kW	2.50	3.50	4.20	
			Btu/h	8,500	11,900	14,300	
		Min.—Max.	kW	0.90—4.65	0.90—4.80	0.90—5.50	
	Heating	Rated	Btu/h	3,100—15,800	3,100—16,300	3,100—18,700	
			kW	3.20	4.00	5.40	
			Btu/h	10,900	13,600	18,400	
Min.—Max.		kW	0.90—7.20	0.90—7.40	0.9—8.20		
		Btu/h	3,100—24,500	3,100—25,200	3,100—27,900		
Input power	Cooling	Rated	kW	0.45	0.76	0.98	
		Max.		1.26	1.50	1.53	
	Heating	Rated	0.58	0.79	1.16		
		Max.	2.20	2.25	2.35		
	Fan	HIGH	MED	W	23.0	23.0	32.0
					13.0	13.0	20.0
					9.0	9.0	12.0
					5.0	5.0	6.0
	Current	Cooling	Rated	A	2.1	3.5	4.4
		Heating		2.7	3.6	5.2	
EER	Cooling		kW/kW	5.56	4.61	4.29	
COP	Heating		kW/kW	5.52	5.06	4.66	
Sensible capacity	Cooling		kW	2.10	2.94	3.59	
Power factor	Cooling		%	93.2	94.4	96.8	
	Heating		%	93.4	95.4	97.0	
Moisture removal			L/h (pints/h)	1.0 (1.8)	1.1 (1.9)	1.7 (3.0)	
Maximum operating current *1	Cooling		A	6.5	7.5	9.0	
	Heating		A	10.5	11.0	11.5	
Fan	Airflow rate	Cooling	m ³ /h	HIGH	830	900	
				MED	680	780	
				LOW	580	630	
				QUIET	380	440	
		Heating	HIGH	830	900		
			MED	680	780		
			LOW	580	630		
			QUIET	380	500		
	Type × Q'ty	Cross flow fan × 1					
	Motor output	W					
Sound pressure level *2	Cooling	HIGH	dB (A)	42	45		
				MED	37	40	
				LOW	33	35	
				QUIET	23	26	
	Heating	HIGH	41	44			
			MED	35	39		
			LOW	31	33		
			QUIET	23	27		
Heat exchanger type	Dimensions (H × W × D)		mm	Main1: 384 × 720 × 30 Sub1: 84 × 720 × 13.3 Sub2: 126 × 720 × 13.3			
	Fin pitch			Main1: 1.2 Sub1: 1.4 Sub2: 1.4			
	Rows × Stages			Main1: 3 × 24 Sub1: 1 × 4 Sub2: 1 × 6			
	Pipe type			Copper			
	Fin type			Aluminum			
	Material			Polystyrene			
Enclosure	Color		White Approximate color of MUNSSELL 5PB 9.25/0.5				
	Dimensions (H × W × D)		mm	295 × 940 × 270			
Weight	Gross			kg	355 × 1,040 × 365		
	Net		14				
Connection pipe	Size	Liquid	mm (in)	Ø 6.35 (Ø 1/4)			
		Gas		Ø 9.52 (Ø 3/8)			
	Method		Flare				
Drain hose	Material		PP+HDPE				
	Size		Ø 13.8 (I.D.), Ø 15.8 to Ø 16.7 (O.D.)				
Operation range	Cooling	°C	18 to 32				
		%RH	80 or less				
Remote controller	Heating	°C	16 to 30				
		Wired remote controller, Wireless remote controller, Mobile app*3 (FGLair™)					

Type	Wall mounted		
	Inverter heat pump		
Model name	ASYG09KHCA	ASYG12KHCA	ASYG14KHCA
<p>NOTES:</p> <ul style="list-style-type: none"> • Specifications are based on the following conditions: <ul style="list-style-type: none"> – Cooling: Indoor temperature of 27 °CDB/19 °CWB, and outdoor temperature of 35 °CDB/24 °CWB. – Heating: Indoor temperature of 20 °CDB/15 °CWB, and outdoor temperature of 7 °CDB/6 °CWB. – Pipe length: 5 m, Height difference: 0 m. (Between outdoor unit and indoor unit.) • Protective function might work when using it outside the operation range. • *1: Maximum current is maximum value when operated within the operation range. • *2: Sound pressure level: <ul style="list-style-type: none"> – Measured values in manufacturer's anechoic chamber. – Because of the surrounding sound environment, the sound levels measured in actual installation conditions might be higher than the specified values here. • *3: Available on Google Play™ store or on App Store®. Optional WLAN adapter is also required. For details, refer to the setting manual. 			

Specifications for ErP Lot10					
Model name		ASYG09KHCA		ASYG12KHCA	ASYG14KHCA
Energy efficiency class	Cooling	A+++		A++	
	Heating (Average)	A+++		A++	
Pdesign	Cooling	kW	2.5 (35 °C)	3.5 (35 °C)	4.2 (35 °C)
	Heating (Average)		2.5 (-10 °C)	3.5 (-10 °C)	4.2 (-10 °C)
SEER	Cooling	kWh/kWh	9.36	9.06	8.36
SCOP	Heating (Average)		5.21	4.89	4.86
Annual energy consumption	QCE	kWh/a	93	135	176
	QHE (Average)		671	1,001	1,209
Sound power level	Cooling	HIGH	dB (A)	57	60
	Heating			57	60

2. Dimensions

2-1. Models: ASYG09KHCA, ASYG12KHCA, and ASYG14KHCA

Unit: mm

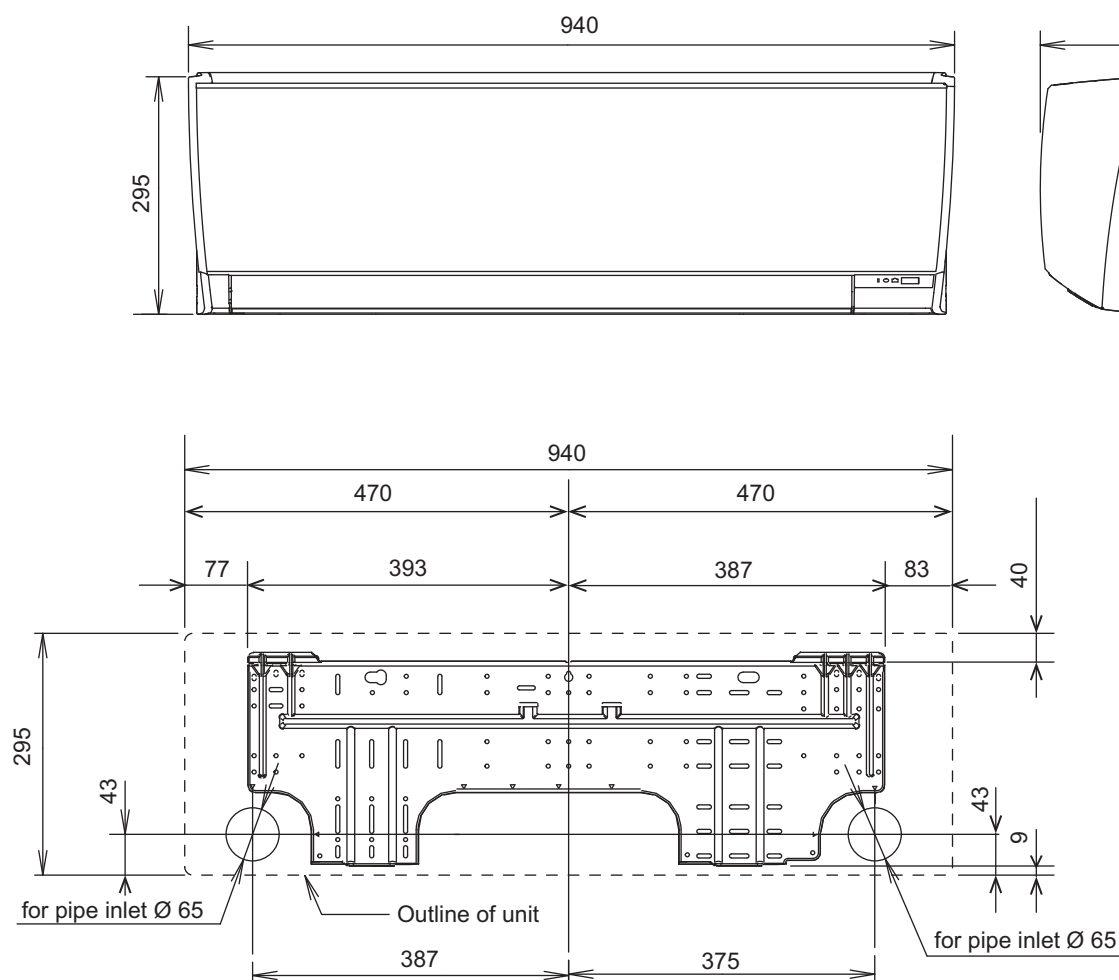

Installation space requirement

Provide sufficient installation space for product safety.

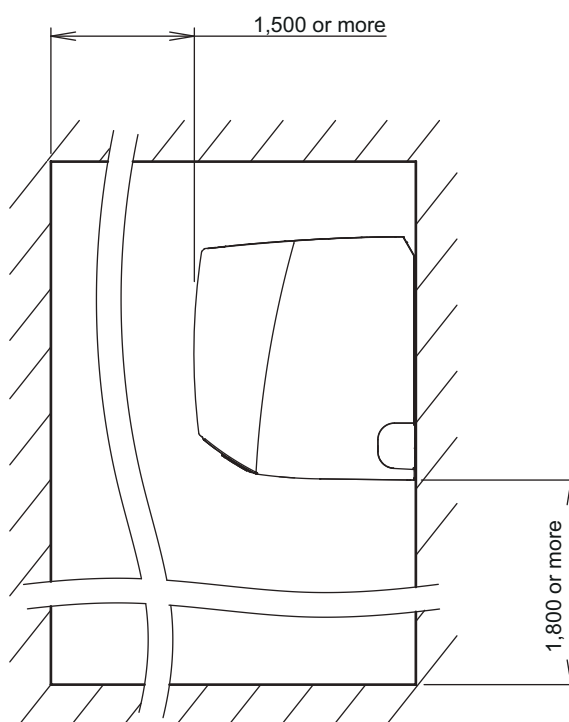
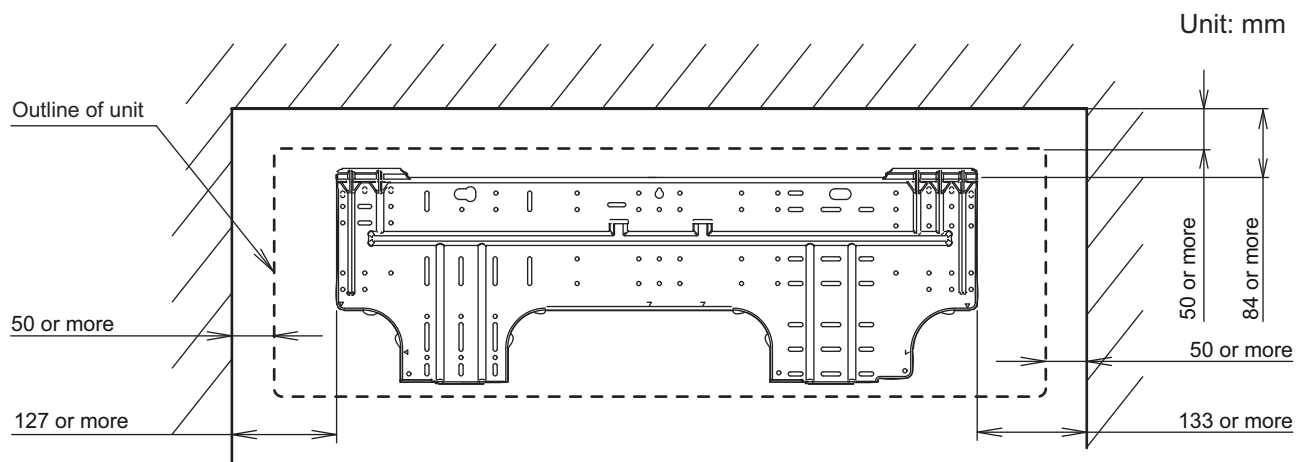

3. Wiring diagrams

3-1. Models: ASYG09KHCA, ASYG12KHCA, and ASYG14KHCA

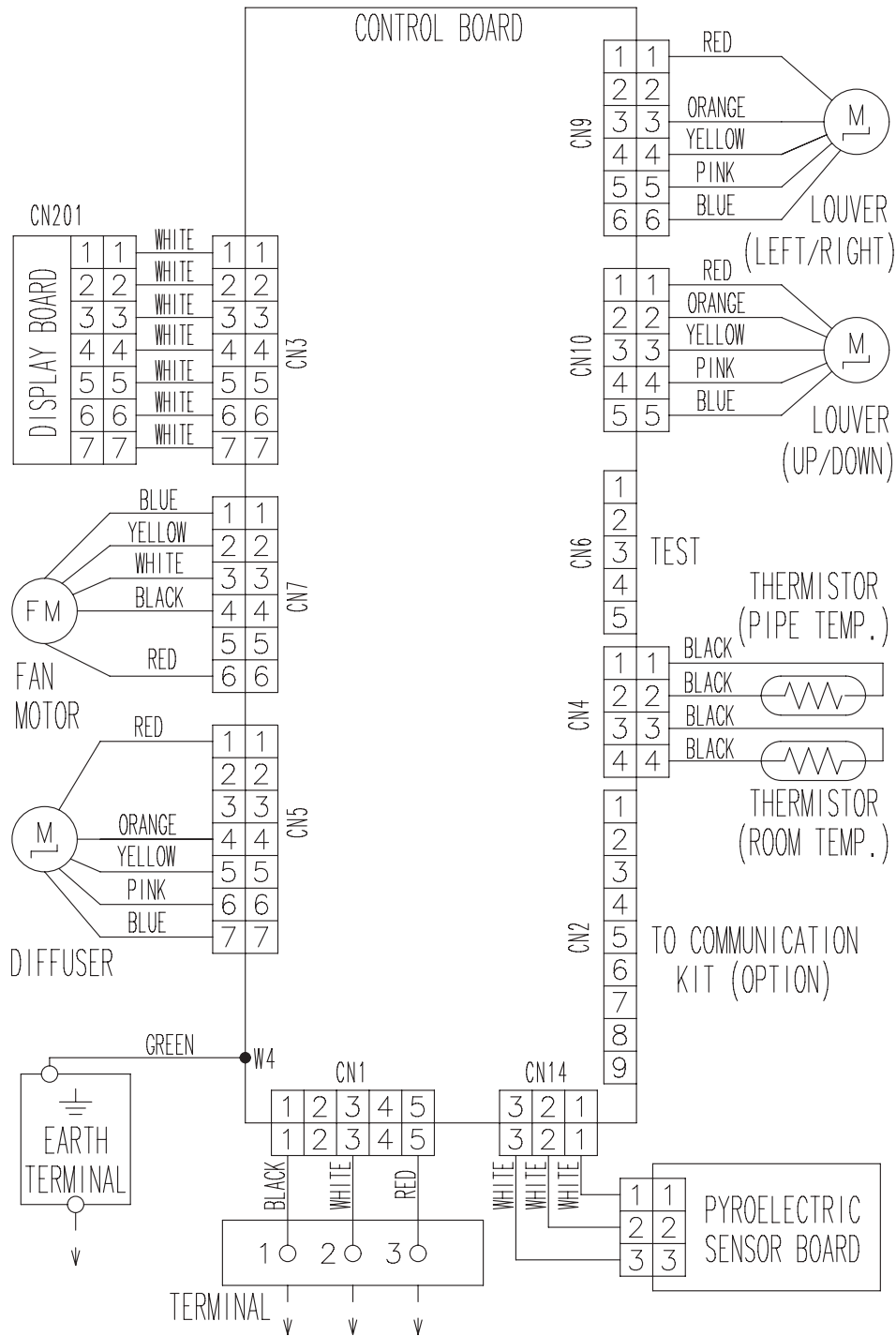

4. Capacity table

Capacity tables show each of following values calculated based on the outdoor temperature and the indoor temperature, under given Airflow Rate (AFR):

For cooling capacity: Total Capacity (TC), Sensible Heat Capacity (SHC), and Input Power (IP)

For heating capacity: Total Capacity (TC) and Input Power (IP)

4-1. Cooling capacity

■ Model: ASYG09KHCA

AFR		m ³ /h																		830		
		Indoor temperature																				
°CDB		18			21			23			25			27			29			32		
°CWB		12			15			16			18			19			21			23		
°CDB		TC	SHC	IP	TC	SHC	IP	TC	SHC	IP	TC	SHC	IP	TC	SHC	IP	TC	SHC	IP	TC	SHC	IP
		kW			kW			kW			kW			kW			kW			kW		
Outdoor temperature	-10.0	2.03	1.74	0.15	2.26	1.75	0.15	2.38	1.82	0.15	2.50	1.91	0.16	2.57	2.05	0.15	2.72	2.05	0.15	2.88	2.11	0.16
	-5.0	2.02	1.72	0.14	2.25	1.73	0.14	2.37	1.81	0.14	2.49	1.89	0.15	2.56	2.04	0.15	2.71	2.04	0.15	2.86	2.11	0.15
	0.0	2.00	1.70	0.15	2.23	1.72	0.15	2.35	1.80	0.15	2.46	1.87	0.15	2.54	2.03	0.15	2.68	2.02	0.15	2.83	2.09	0.15
	5.0	1.99	1.70	0.15	2.22	1.70	0.15	2.34	1.78	0.15	2.45	1.86	0.15	2.52	2.01	0.15	2.67	1.99	0.15	2.82	2.07	0.15
	10.0	1.97	1.68	0.14	2.19	1.69	0.14	2.31	1.77	0.15	2.43	1.84	0.15	2.50	2.00	0.15	2.64	1.98	0.15	2.80	2.06	0.15
	15.0	2.07	1.78	0.16	2.31	1.78	0.16	2.43	1.87	0.16	2.55	1.94	0.17	2.63	2.10	0.16	2.78	2.09	0.16	2.94	2.17	0.17
	20.0	2.34	1.93	0.30	2.61	1.94	0.30	2.70	2.02	0.31	2.87	2.11	0.31	2.96	2.28	0.31	3.14	2.27	0.31	3.32	2.33	0.32
	25.0	2.23	1.86	0.34	2.49	1.87	0.34	2.57	1.95	0.34	2.74	2.05	0.35	2.82	2.20	0.35	2.99	2.19	0.35	3.16	2.25	0.35
	30.0	2.10	1.85	0.39	2.34	1.86	0.39	2.42	1.94	0.39	2.58	2.03	0.40	2.66	2.19	0.40	2.82	2.19	0.41	2.98	2.23	0.41
	35.0	1.98	1.77	0.43	2.20	1.78	0.44	2.28	1.86	0.44	2.43	1.95	0.45	2.50	2.10	0.45	2.65	2.09	0.46	2.80	2.14	0.46
	40.0	1.83	1.59	0.40	2.04	1.73	0.41	2.11	1.81	0.41	2.25	1.88	0.42	2.32	2.04	0.42	2.46	2.03	0.42	2.60	2.08	0.42
46.0	1.79	1.63	0.40	2.01	1.73	0.41	2.07	1.82	0.41	2.20	1.90	0.41	2.28	2.05	0.41	2.41	2.04	0.41	2.53	2.09	0.41	

■ Model: ASYG12KHCA

AFR		m ³ /h																		830		
		Indoor temperature																				
°CDB		18			21			23			25			27			29			32		
°CWB		12			15			16			18			19			21			23		
°CDB		TC	SHC	IP	TC	SHC	IP	TC	SHC	IP	TC	SHC	IP	TC	SHC	IP	TC	SHC	IP	TC	SHC	IP
		kW			kW			kW			kW			kW			kW			kW		
Outdoor temperature	-10.0	2.84	2.42	0.24	3.16	2.43	0.24	3.33	2.55	0.25	3.54	2.70	0.25	3.60	2.88	0.25	3.81	2.85	0.25	4.02	3.04	0.26
	-5.0	2.82	2.41	0.24	3.15	2.42	0.24	3.31	2.54	0.25	3.52	2.69	0.25	3.58	2.86	0.25	3.79	2.84	0.25	4.00	3.03	0.26
	0.0	2.80	2.40	0.24	3.12	2.40	0.24	3.29	2.51	0.24	3.49	2.67	0.25	3.55	2.84	0.25	3.76	2.82	0.25	3.97	3.01	0.26
	5.0	2.78	2.37	0.24	3.11	2.38	0.24	3.27	2.49	0.24	3.47	2.64	0.24	3.53	2.81	0.25	3.74	2.79	0.25	3.95	2.97	0.26
	10.0	2.76	2.36	0.24	3.08	2.37	0.24	3.24	2.49	0.25	3.44	2.63	0.25	3.50	2.79	0.25	3.71	2.79	0.25	3.92	2.97	0.26
	15.0	2.90	2.49	0.27	3.24	2.51	0.27	3.40	2.62	0.27	3.62	2.77	0.28	3.68	2.95	0.28	3.90	2.94	0.28	4.12	3.13	0.28
	20.0	3.28	2.70	0.50	3.65	2.71	0.51	3.77	2.83	0.51	4.02	3.00	0.52	4.15	3.19	0.52	4.40	3.17	0.52	4.64	3.38	0.53
	25.0	3.12	2.60	0.59	3.47	2.61	0.59	3.59	2.74	0.60	3.83	2.90	0.60	3.95	3.08	0.60	4.18	3.06	0.61	4.42	3.26	0.62
	30.0	2.95	2.59	0.66	3.28	2.60	0.67	3.40	2.72	0.67	3.62	2.89	0.67	3.73	3.06	0.68	3.96	3.05	0.69	4.18	3.26	0.70
	35.0	2.77	2.48	0.73	3.08	2.49	0.74	3.19	2.61	0.75	3.40	2.76	0.76	3.50	2.94	0.76	3.71	2.93	0.77	3.92	3.11	0.78
	40.0	2.57	2.42	0.69	2.85	2.43	0.70	2.95	2.53	0.71	3.15	2.68	0.71	3.25	2.86	0.71	3.45	2.85	0.72	3.63	3.03	0.73
46.0	2.53	2.28	0.68	2.84	2.43	0.69	2.92	2.54	0.70	3.10	2.68	0.70	3.19	2.87	0.70	3.40	2.86	0.71	3.59	3.04	0.72	

■ Model: ASYG14KHCA

AFR		m ³ /h																		900		
		Indoor temperature																				
°CDB		18			21			23			25			27			29			32		
°CWB		12			15			16			18			19			21			23		
°CDB		TC	SHC	IP	TC	SHC	IP	TC	SHC	IP	TC	SHC	IP	TC	SHC	IP	TC	SHC	IP	TC	SHC	IP
		kW			kW			kW			kW			kW			kW			kW		
Outdoor temperature	-10.0	3.41	2.77	0.31	3.80	3.09	0.32	4.00	3.11	0.32	4.19	3.40	0.34	4.32	3.51	0.32	4.57	3.71	0.33	4.83	3.92	0.34
	-5.0	3.40	2.75	0.31	3.78	3.07	0.31	3.98	3.09	0.31	4.17	3.38	0.33	4.30	3.49	0.32	4.55	3.69	0.32	4.81	3.90	0.33
	0.0	3.36	2.73	0.31	3.75	3.04	0.31	3.94	3.07	0.31	4.14	3.37	0.33	4.26	3.46	0.32	4.51	3.67	0.32	4.77	3.88	0.33
	5.0	3.35	2.70	0.31	3.73	3.02	0.31	3.92	3.04	0.31	4.11	3.32	0.33	4.24	3.43	0.32	4.48	3.62	0.32	4.74	3.84	0.33
	10.0	3.32	2.69	0.32	3.69	2.99	0.32	3.88	3.02	0.32	4.08	3.30	0.33	4.20	3.41	0.32	4.45	3.60	0.32	4.70	3.81	0.33
	15.0	3.48	2.84	0.34	3.88	3.17	0.35	4.08	3.19	0.35	4.28	3.49	0.37	4.42	3.59	0.36	4.67	3.82	0.36	4.94	4.03	0.37
	20.0	3.93	3.28	0.66	4.38	3.30	0.67	4.53	3.45	0.67	4.83	3.59	0.67	4.98	3.89	0.67	5.27	3.86	0.68	5.57	4.13	0.68
	25.0	3.74	3.17	0.74	4.18	3.19	0.75	4.32	3.33	0.76	4.60	3.48	0.77	4.74	3.76	0.77	5.03	3.75	0.78	5.31	3.99	0.78
	30.0	3.53	3.15	0.85	3.94	3.17	0.86	4.08	3.31	0.87	4.35	3.46	0.87	4.48	3.74	0.87	4.75	3.72	0.88	5.02	3.97	0.88
	35.0	3.32	3.02	0.95	3.70	3.05	0.96	3.82	3.19	0.97	4.07	3.32	0.97	4.20	3.59	0.98	4.45	3.57	0.99	4.70	3.80	0.99
	40.0	3.09	2.94	0.89	3.43	2.95	0.91	3.55	3.10	0.91	3.78	3.23	0.92	3.90	3.48	0.92	4.13	3.47	0.93	4.37	3.70	0.93
46.0	3.03	2.97	0.87	3.38	2.98	0.88	3.49	3.11	0.88	3.72	3.24	0.90	3.83	3.50	0.90	4.06	3.48	0.91	4.31	3.72	0.90	

4-2. Heating capacity

■ Model: ASYG09KHCA

AFR		m ³ /h		830								
		Indoor temperature										
		16		18		20		22		24		
Outdoor temperature	°CDB	°CWB	TC	IP	TC	IP	TC	IP	TC	IP	TC	IP
			kW		kW		kW		kW		kW	
	-25	-26	3.31	1.60	3.23	1.62	3.15	1.65	3.07	1.72	2.99	1.75
	-20	-21	3.55	1.74	3.45	1.77	3.38	1.80	3.30	1.87	3.21	1.91
	-15	-16	4.29	1.90	4.19	1.93	4.09	1.97	3.98	2.05	3.88	2.09
	-10	-11	5.35	1.94	5.23	1.97	5.10	2.02	4.97	2.09	4.85	2.14
	-5	-7	5.98	1.96	5.84	2.00	5.70	2.04	5.56	2.12	5.41	2.16
	0	-2	6.39	2.00	6.25	2.04	6.09	2.08	5.94	2.17	5.78	2.20
	5	3	7.20	2.09	7.03	2.13	6.86	2.17	6.68	2.26	6.52	2.30
	7	6	7.55	2.11	7.38	2.16	7.20	2.21	7.02	2.30	6.84	2.34
10	8	7.95	1.99	7.76	2.04	7.57	2.07	7.38	2.15	7.19	2.20	
15	10	8.13	1.79	7.94	1.84	7.74	1.87	7.55	1.95	7.36	1.98	
20	15	8.39	1.61	8.19	1.64	7.99	1.67	7.80	1.74	7.59	1.77	
24	18	7.62	1.45	7.44	1.49	7.26	1.51	7.08	1.58	6.90	1.61	

■ Model: ASYG12KHCA

AFR		m ³ /h		830								
		Indoor temperature										
		16		18		20		22		24		
Outdoor temperature	°CDB	°CWB	TC	IP	TC	IP	TC	IP	TC	IP	TC	IP
			kW		kW		kW		kW		kW	
	-25	-26	3.41	1.62	3.32	1.65	3.24	1.68	3.08	1.75	3.00	1.78
	-20	-21	3.65	1.77	3.56	1.80	3.48	1.83	3.30	1.90	3.22	1.95
	-15	-16	4.41	1.93	4.30	1.97	4.20	2.00	3.99	2.08	3.88	2.13
	-10	-11	5.50	1.97	5.37	2.01	5.24	2.05	4.99	2.13	4.85	2.17
	-5	-7	6.15	1.99	6.00	2.03	5.86	2.07	5.56	2.16	5.41	2.19
	0	-2	6.58	2.03	6.42	2.07	6.26	2.11	5.95	2.19	5.79	2.24
	5	3	7.40	2.11	7.23	2.16	7.05	2.20	6.70	2.29	6.52	2.34
	7	6	7.77	2.15	7.58	2.18	7.40	2.24	7.03	2.33	6.84	2.38
10	8	8.16	2.01	7.97	2.05	7.78	2.10	7.39	2.18	7.19	2.22	
15	10	8.36	1.82	8.16	1.87	7.96	1.90	7.56	1.98	7.37	2.01	
20	15	8.63	1.63	8.42	1.67	8.21	1.70	7.80	1.77	7.60	1.80	
24	18	7.83	1.48	7.64	1.51	7.46	1.53	7.08	1.60	6.90	1.62	

■ Model: ASYG14KHCA

AFR		m ³ /h		900								
		Indoor temperature										
		16		18		20		22		24		
Outdoor temperature	°CDB	°CWB	TC	IP	TC	IP	TC	IP	TC	IP	TC	IP
			kW		kW		kW		kW		kW	
	-25	-26	4.67	2.06	4.56	2.10	4.45	2.14	4.22	2.23	4.11	2.27
	-20	-21	5.18	2.32	5.06	2.36	4.93	2.40	4.69	2.50	4.57	2.54
	-15	-16	6.17	2.51	6.03	2.56	5.88	2.60	5.59	2.72	5.44	2.77
	-10	-11	6.72	2.45	6.57	2.49	6.41	2.53	6.09	2.64	5.93	2.69
	-5	-7	7.29	2.38	7.11	2.42	6.93	2.47	6.59	2.56	6.42	2.62
	0	-2	7.83	2.32	7.65	2.36	7.46	2.40	7.08	2.50	6.90	2.55
	5	3	8.39	2.24	8.19	2.28	7.99	2.34	7.59	2.43	7.39	2.48
	7	6	8.61	2.21	8.40	2.26	8.20	2.31	7.79	2.40	7.58	2.44
10	8	9.05	2.08	8.83	2.12	8.62	2.16	8.19	2.25	7.98	2.29	
15	10	9.26	1.88	9.04	1.92	8.82	1.96	8.38	2.03	8.15	2.07	
20	15	9.56	1.67	9.33	1.72	9.10	1.75	8.65	1.81	8.42	1.86	
24	18	8.68	1.51	8.47	1.54	8.27	1.58	7.86	1.64	7.65	1.68	

5. Fan performance

5-1. Air velocity distributions

■ Models: ASYG09KHCA and ASYG12KHCA

Measuring conditions	Fan speed	Operation mode
	HIGH	FAN

Top view
Vertical airflow direction louver: Up
Horizontal airflow direction louver: Center

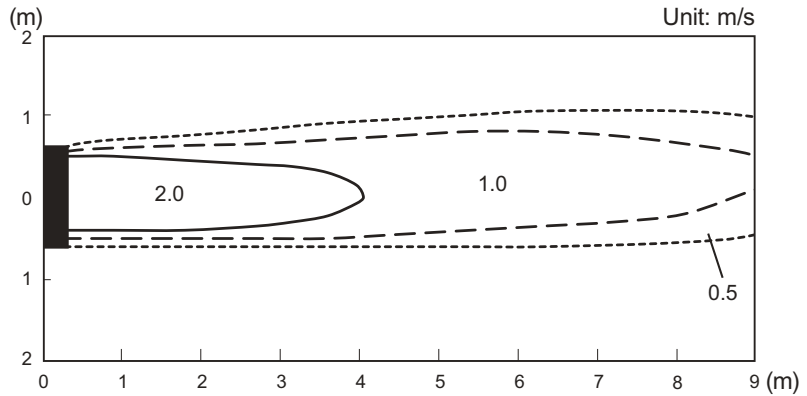

Top view
Vertical airflow direction louver: Up
Horizontal airflow direction louver: Left & Right

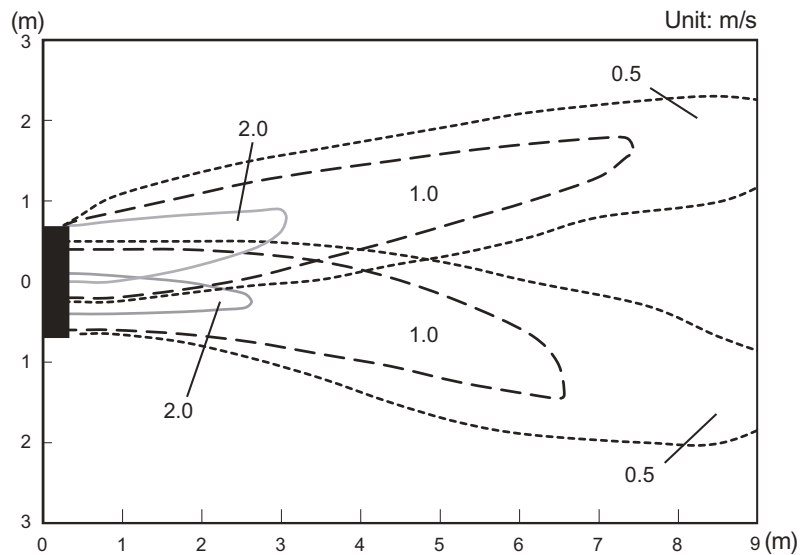

Side view
Vertical airflow direction louver: Up
Horizontal airflow direction louver: Center

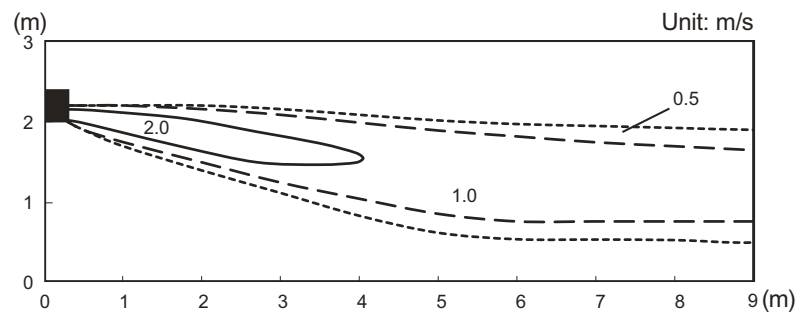

Side view
Vertical airflow direction louver: Down
Horizontal airflow direction louver: Center

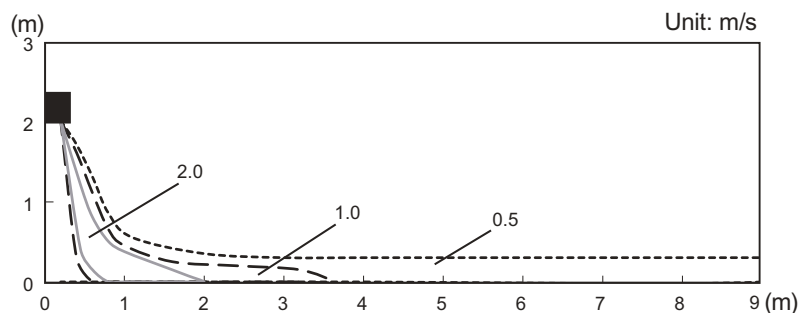

Model: ASYG14KHCA

Measuring conditions	Fan speed	Operation mode
	HIGH	FAN

Top view
Vertical airflow direction louver: Up
Horizontal airflow direction louver: Center

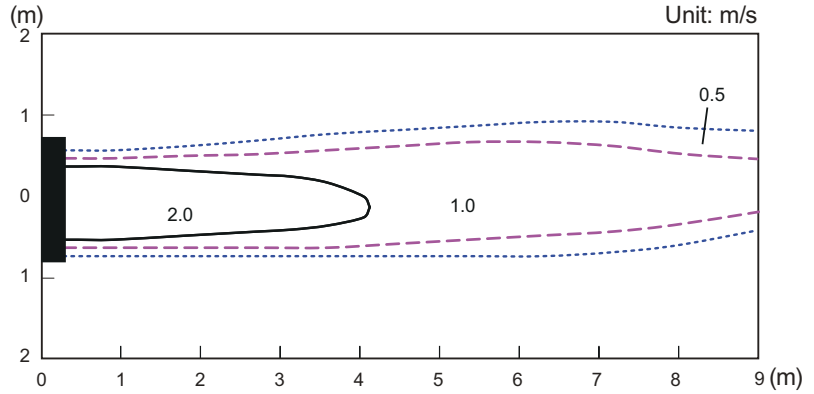

Top view
Vertical airflow direction louver: Up
Horizontal airflow direction louver: Left & Right

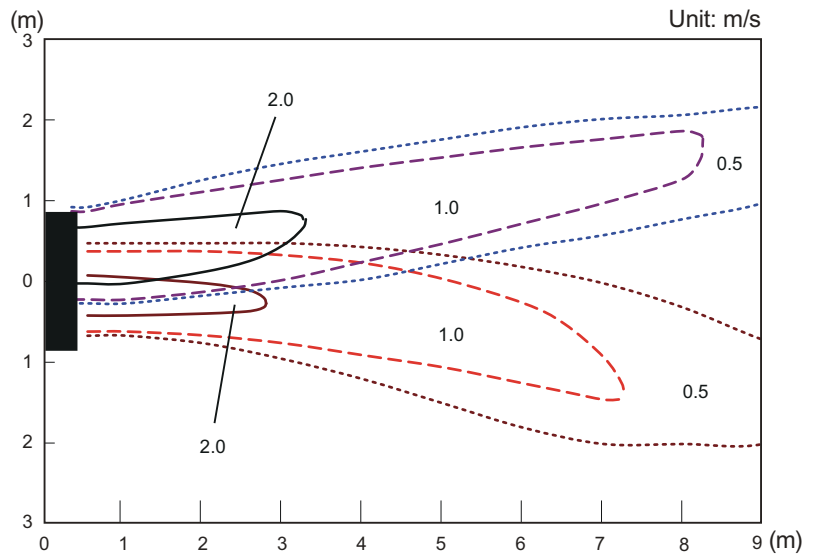

Side view
Vertical airflow direction louver: Up
Horizontal airflow direction louver: Center

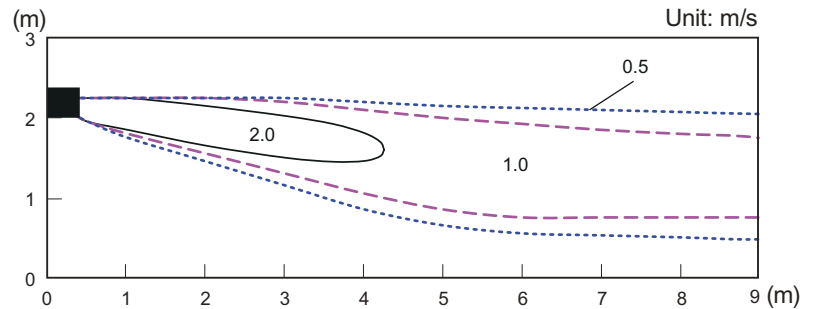

Side view
Vertical airflow direction louver: Down
Horizontal airflow direction louver: Center

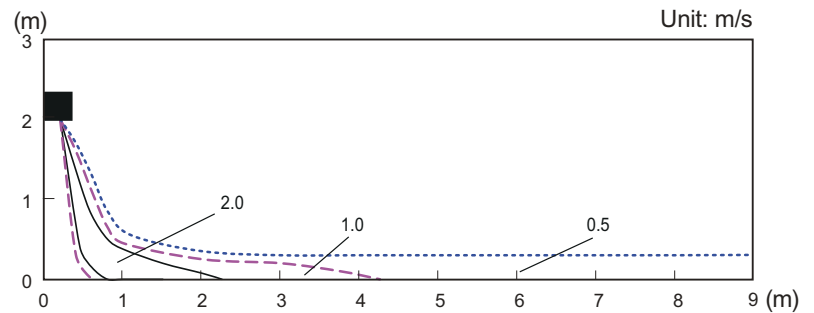

5-2. Airflow

■ Models: ASYG09KHCA and ASYG12KHCA

● Cooling

Fan speed	Airflow	
HIGH	m ³ /h	830
	l/s	231
	CFM	489
MED	m ³ /h	680
	l/s	189
	CFM	400
LOW	m ³ /h	580
	l/s	161
	CFM	341
QUIET	m ³ /h	380
	l/s	106
	CFM	224

● Heating

Fan speed	Airflow	
HIGH	m ³ /h	830
	l/s	231
	CFM	489
MED	m ³ /h	680
	l/s	189
	CFM	400
LOW	m ³ /h	580
	l/s	161
	CFM	341
QUIET	m ³ /h	380
	l/s	106
	CFM	224

■ Model: ASYG14KHCA

● Cooling

Fan speed	Airflow	
HIGH	m ³ /h	900
	l/s	250
	CFM	530
MED	m ³ /h	780
	l/s	217
	CFM	459
LOW	m ³ /h	630
	l/s	175
	CFM	371
QUIET	m ³ /h	440
	l/s	122
	CFM	259

● Heating

Fan speed	Airflow	
HIGH	m ³ /h	900
	l/s	250
	CFM	530
MED	m ³ /h	780
	l/s	217
	CFM	459
LOW	m ³ /h	630
	l/s	175
	CFM	371
QUIET	m ³ /h	500
	l/s	139
	CFM	294

6. Operation noise (sound pressure)

6-1. Noise level curve

Model: ASYG09KHCA

● Cooling

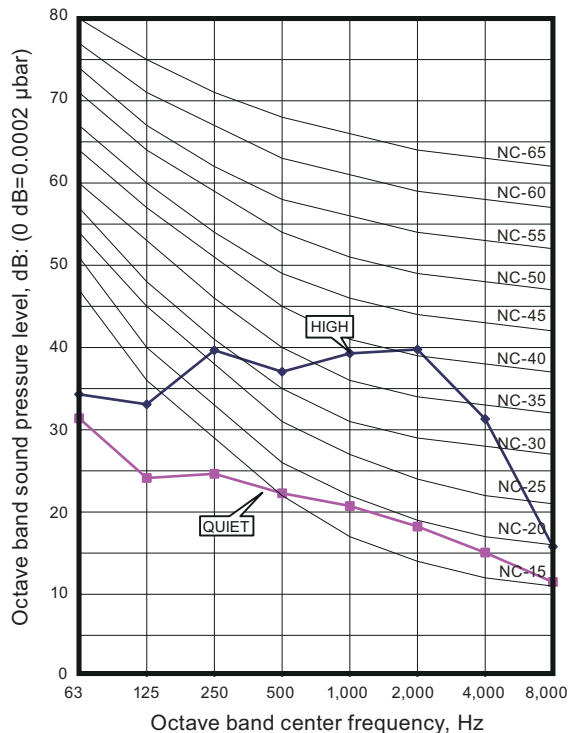

● Heating

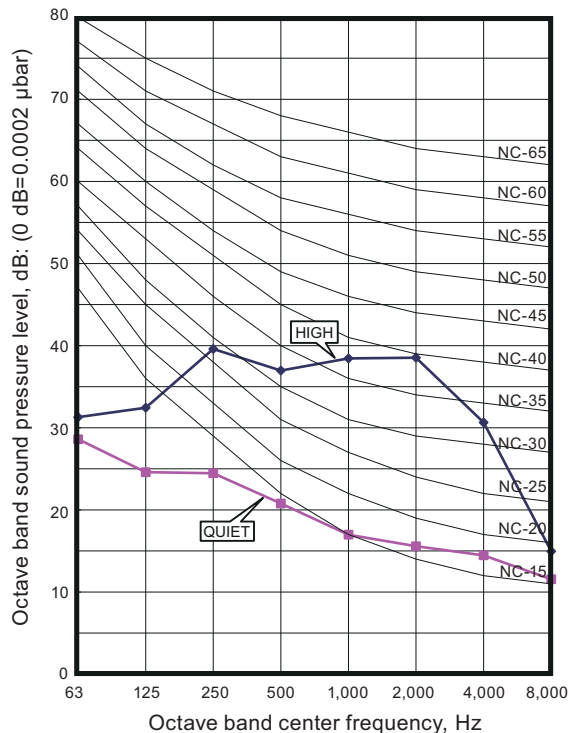

Model: ASYG12KHCA

● Cooling

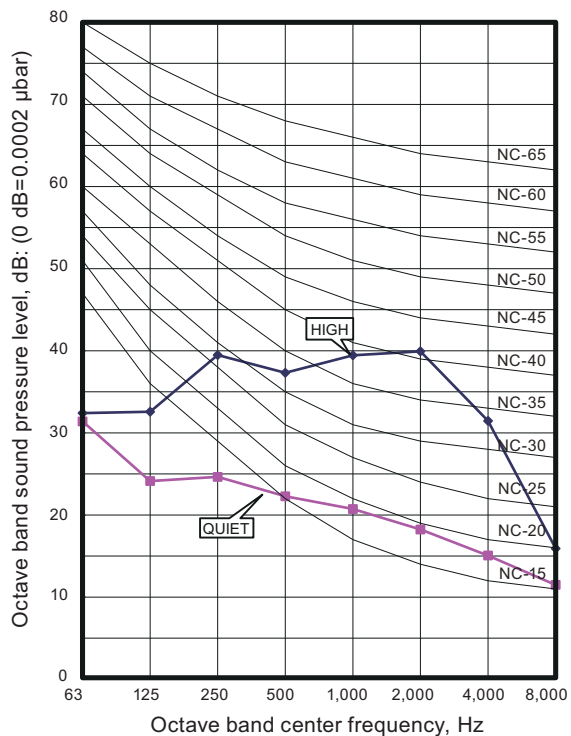

● Heating

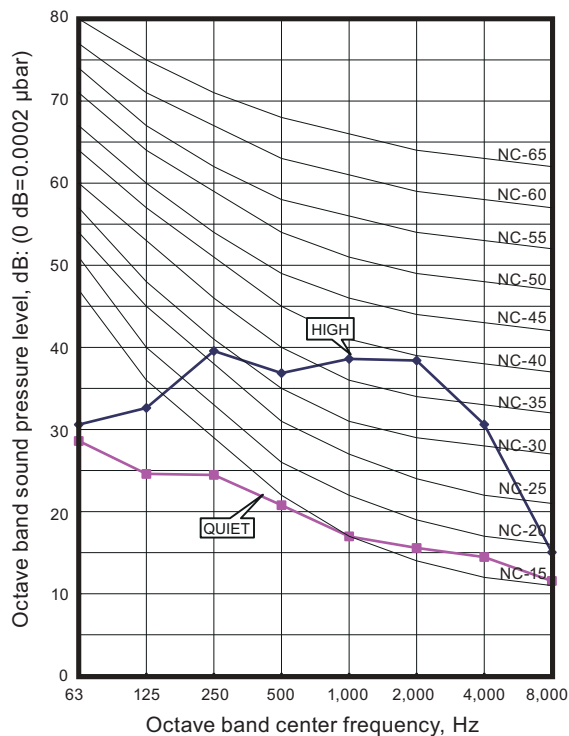

Model: ASYG14KHCA

● Cooling

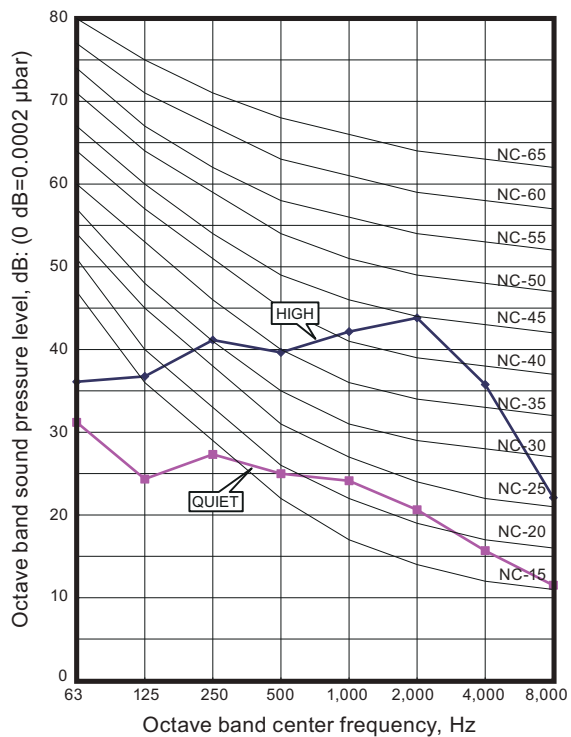

● Heating

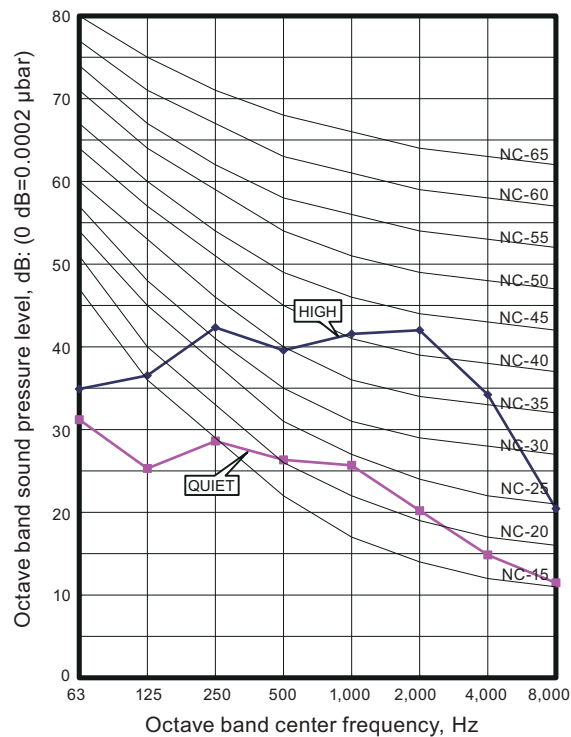

6-2. Sound level check point

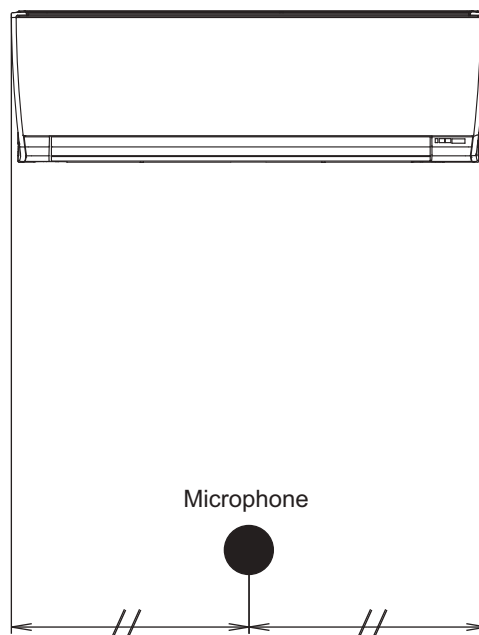
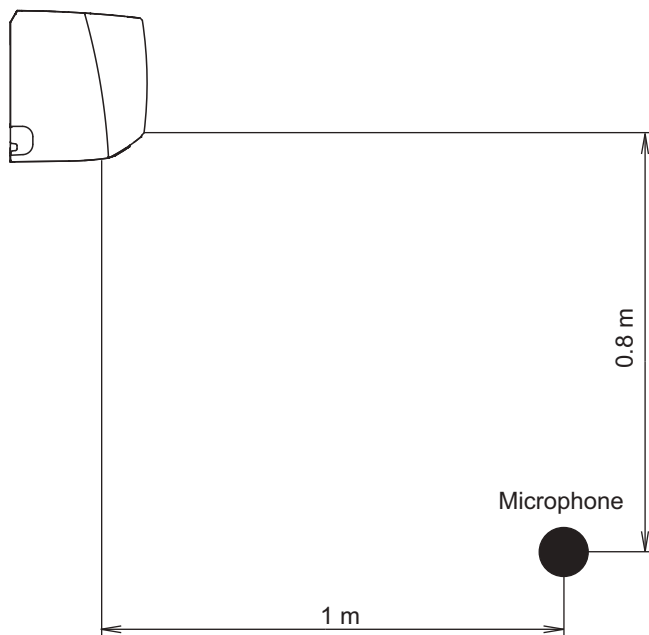

7. Safety devices

Type of protection	Protection form		Model		
			ASYG09KHCA	ASYG12KHCA	ASYG14KHCA
Circuit protection	Current fuse (PCB*)		250 V, 3.15 A		
Fan motor protection	Thermal protector program	Activate	150 ±15°C Fan motor stop		
		Reset	120 ±15°C Fan motor restart		

*PCB: Printed Circuit Board

8. External input and output

With using external input and output functions, this product can be operated inter-connectedly with an external device.

Connector	Input	Output	Remarks
CNA01	Control input	—	See external input/output settings for details.
CNB01	—	Operation status output	
CNB02	—	Error status output	

8-1. External input

With using external input function, some functions on this product can be controlled from an external device.

- “Operation/Stop” mode can be selected with function setting of indoor unit.
- A twisted pair cable (22AWG) should be used. Maximum length of cable is 150 m.
- The wire connection should be separate from the power cable line.

■ Control input (Operation/Stop or Forced stop)

The air conditioner can be remotely operated by means of the following on-site work.

Unit operation is started at the following contents by adding the contact input of a commercial on/off switch to a connector on the external control PCB and turning it on.

Unit operation	Initial setting after power is on	Starting mode other than initial setting
Operation mode	Auto changeover	Mode at previous operation
Set temperature	24 °C	Temperature at previous operation
Airflow mode	AUTO	Mode at previous operation
Air direction (swing)	Standard air direction (swing: off)	Air direction at previous operation

• **Circuit diagram example**

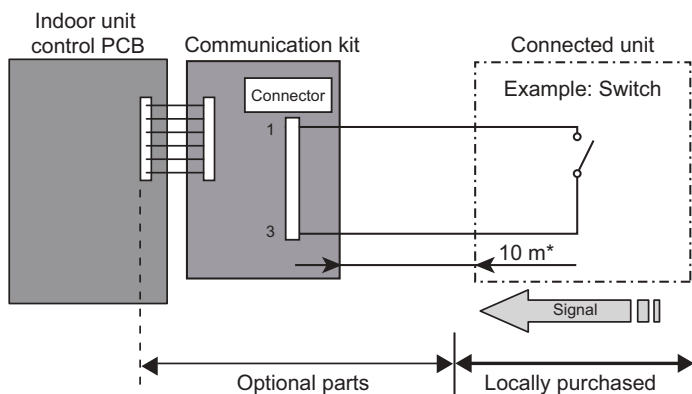

- Contact capacity: DC 24 V or more, 10 mA or more.
- *: Make the distance from the PCB to the connected unit within 10 m.
- Use non-polar relays and switches.

– When function setting is “Operation/Stop” mode

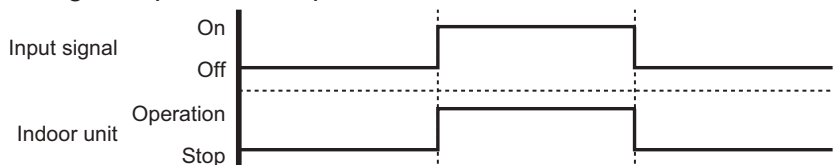

– When function setting is “Forced stop” mode

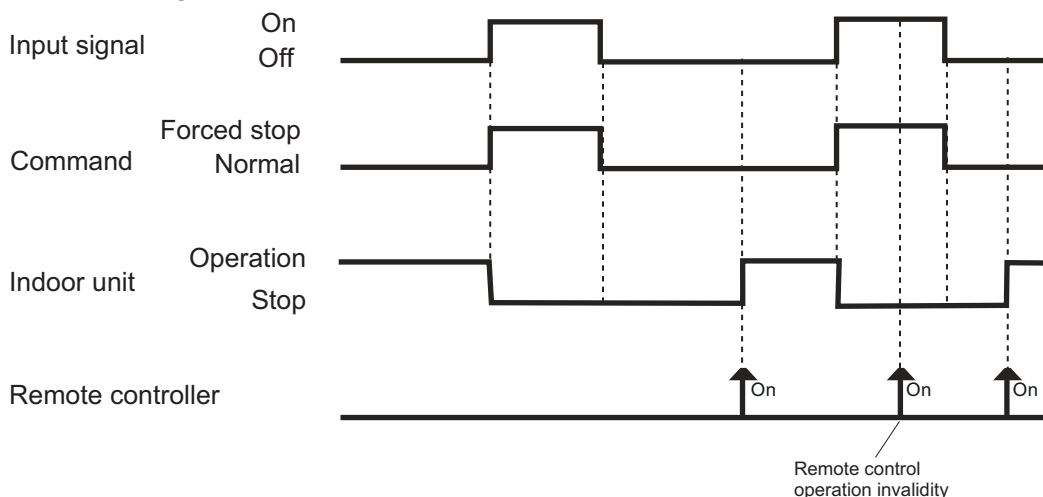

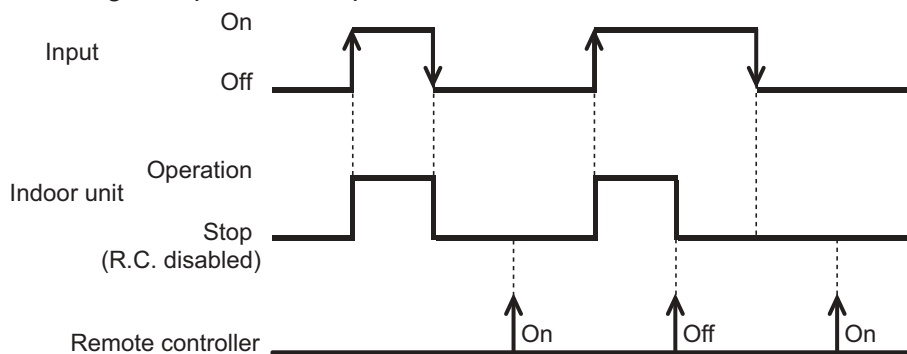

– When function setting is "Operation/Stop" mode 2

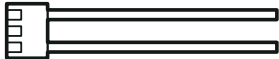

NOTE: When "Operation/Stop" mode 2 function is used with forming a remote controller group, connect the same equipment to each indoor unit within the group.

- **Optional part**

Part name	Model name	Exterior
External connect kit	UTY-XWZXZ5	External input wire 
Communication kit	UTY-TWBXF1	

* For operating the external function, the wall mounted type requires the communication kit in addition to the wire (UTY-XWZXZ5).

8-2. External output

With using external output function, operating status of this product can be transmitted to the external device, and also, this product can be inter-connected with the external device.

■ Operation status output

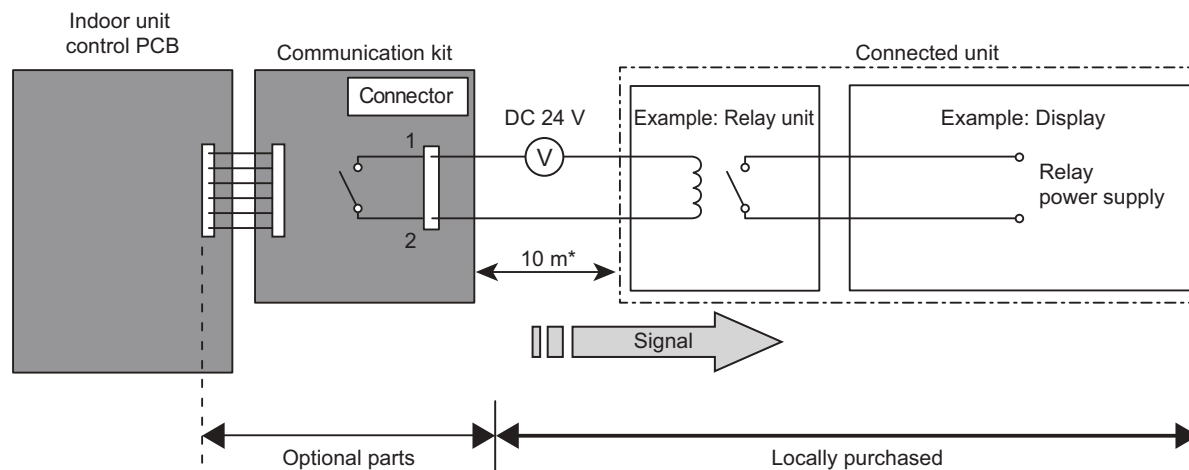

● Circuit diagram example

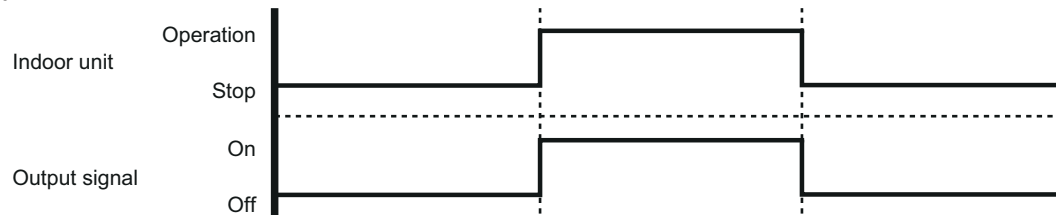

- *: Make the distance from the PCB to the connected unit within 10 m.
- Relay spec: Max. DC 24 V, 10 mA to less than 500 mA.



● Optional part

Part name	Model name	Exterior
External connect kit	UTY-XWZXZ5	External output wire 
Communication kit	UTY-TWBXF1	

* For operating the external function, the wall mounted type requires the communication kit in addition to the wire (UTY-XWZXZ5).

■ Error status output

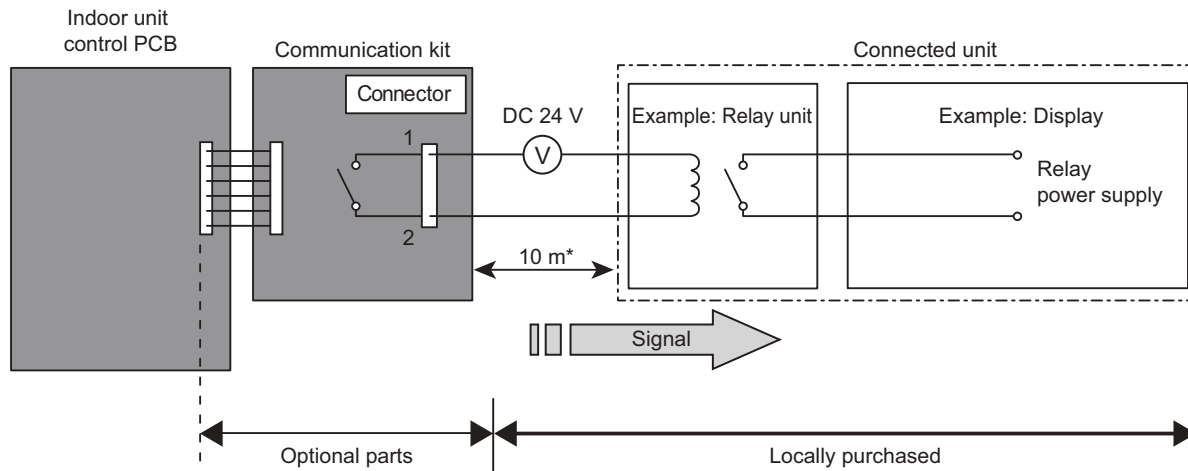

● Circuit diagram example

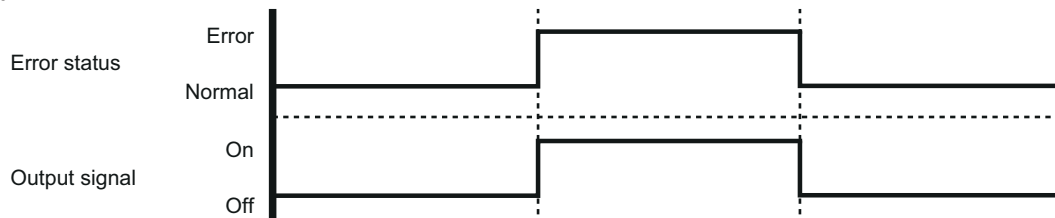

- *: Make the distance from the PCB to the connected unit within 10 m.
- Relay spec: Max. DC 24 V, 10 mA to less than 500 mA.

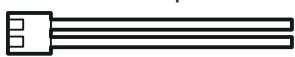

● Optional part

Part name	Model name	Exterior
External connect kit	UTY-XWZXZ5	External output wire 
Communication kit	UTY-TWBXF1	

* For operating the external function, the wall mounted type requires the communication kit in addition to the wire (UTY-XWZXZ5).

9. Group connection

Installation procedure for group control system:

A number of indoor units can be operated at the same time using a single remote controller.

NOTE: When different type of indoor units (such as wall mounted type and cassette type, cassette type and duct type, or other combinations) are connected using group control system, some functions may no longer be available.

1. Connect up to 16 indoor units in a system.

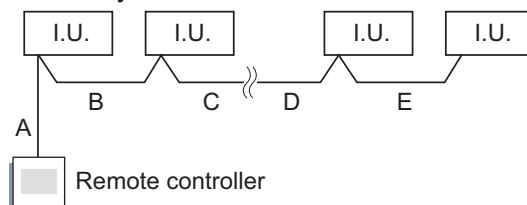

A, B, C, D, E: Remote controller cable	
Wiring length limitation	$A + B + C + D + E \leq 500 \text{ m}$

2. Set the R.C. address. (Function setting)

- Addresses will be automatically set when initially starting up this unit. In such a case, do not change the remote controller address for the indoor unit, and keep it at the initial setting of "00".
- Only set addresses manually when using different numbers for addresses. Set the R.C. address of each indoor unit using the function setting. (Refer to "Remote controller address setting" in ["Contents of function setting"](#) on page 26.)

NOTES:

– Do not use the same setting value.

– Setting is reflected after the power is turned on again.

Also set the R.C. address for the remote controller. For details, refer to the remote controller installation manual.

NOTE: In manual setting, connect up to 15 indoor units in a system.

Example of wiring method

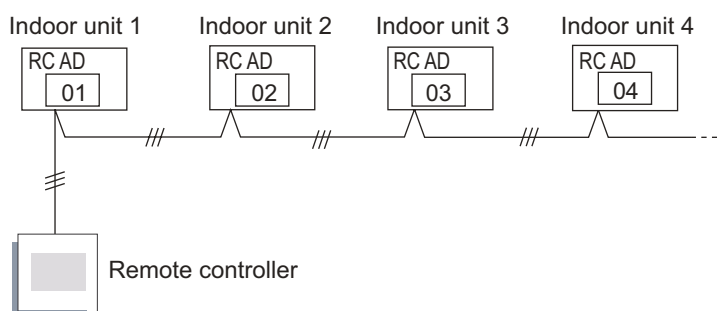

10. Remote controller

10-1. Wireless remote controller

Overview

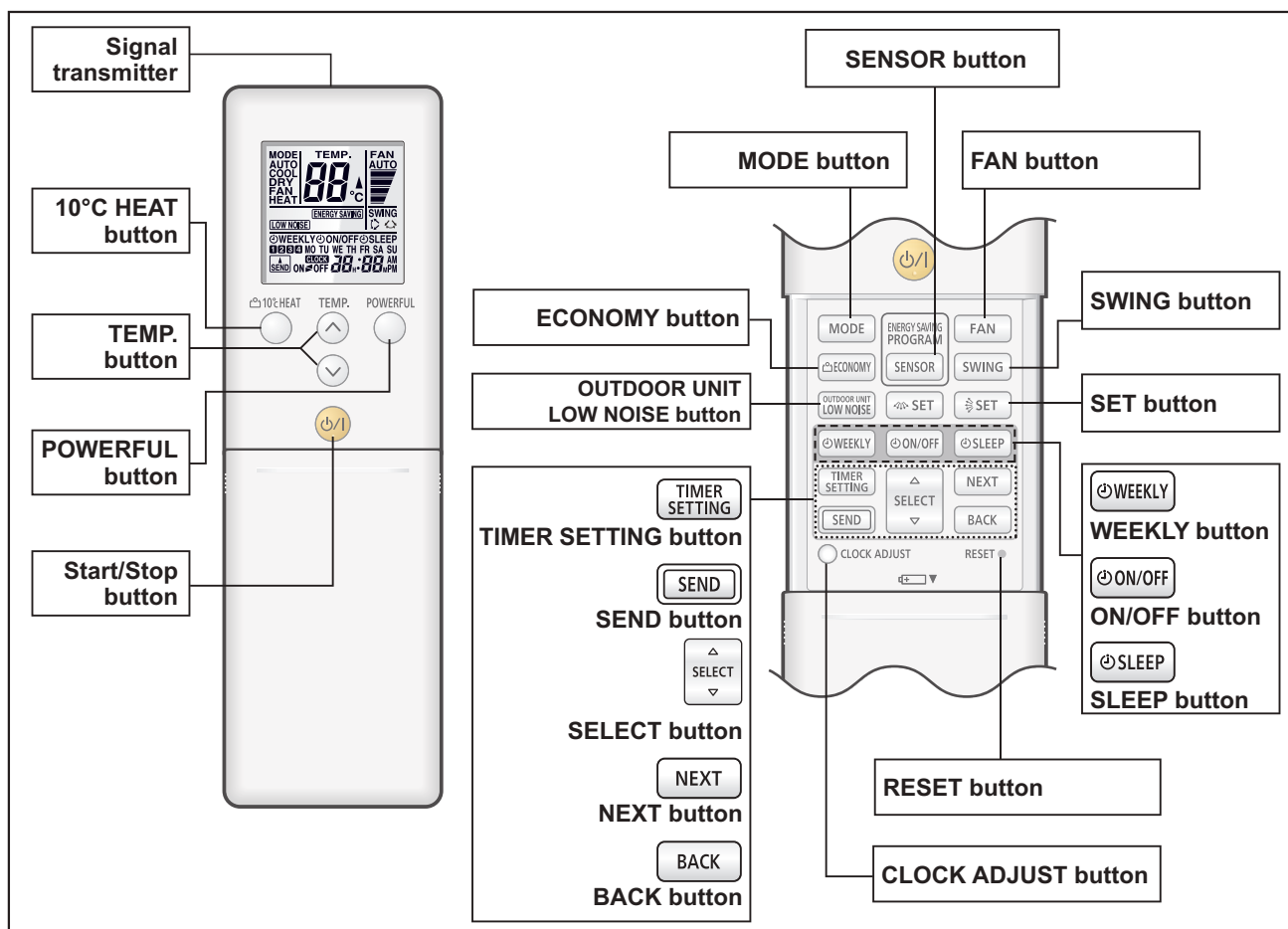

NOTE: Functions may differ by type of the indoor unit. For details, refer to the operation manual.

Display panel

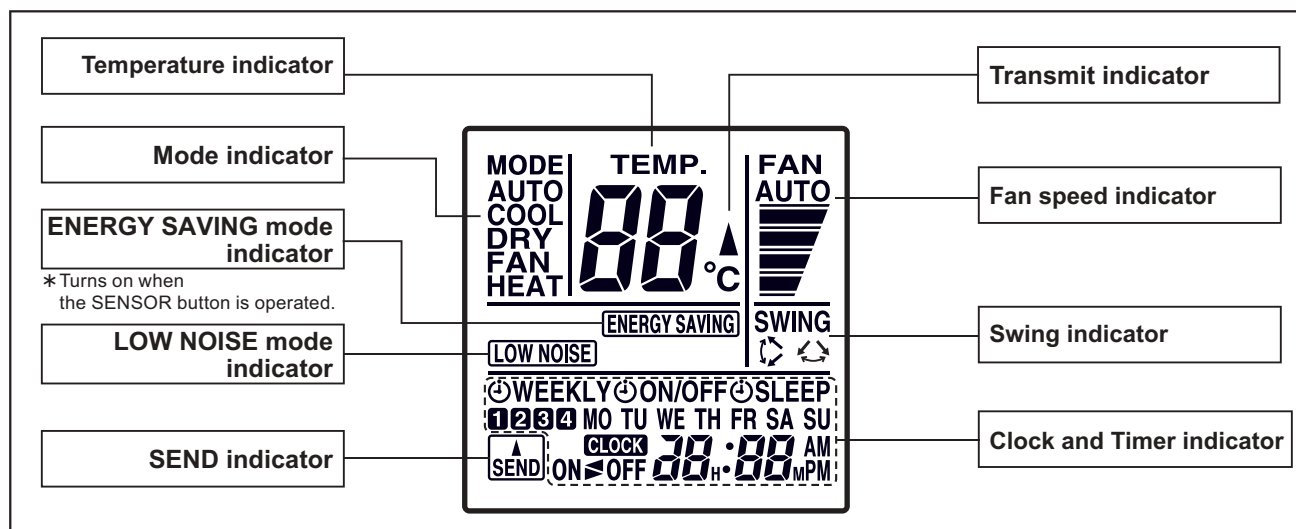

To facilitate explanation, the accompanying illustration has been drawn to show all possible indicators; in actual operation, however, the display will only show those indicators appropriate to the current operation.

■ Specifications

● Controller

Unit: mm

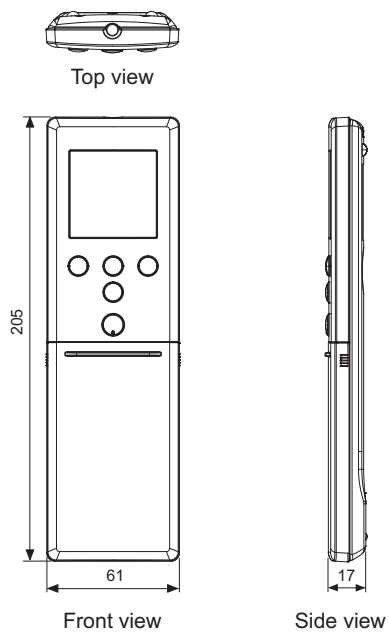

Size (H × W × D)	mm	205 × 61 × 17
Weight	g	124 (without batteries)

● Holder

Unit: mm

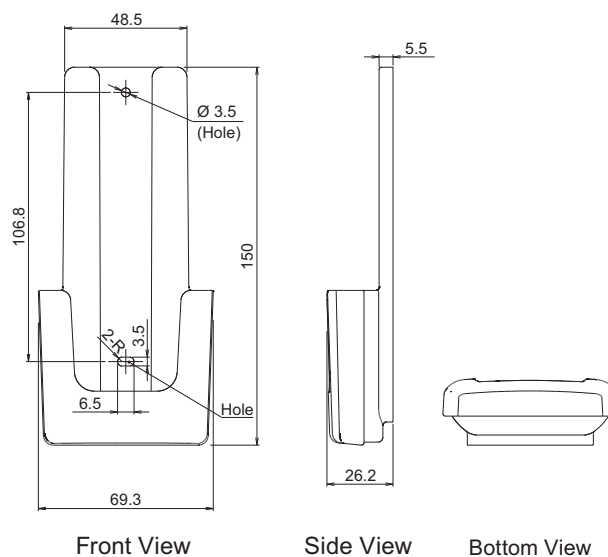

Size (H × W × D)	mm	150 × 69.3 × 26.2
Weight	g	27

11. Function settings

To adjust the functions of this product according to the installation environment, various types of function settings are available.

NOTE: Incorrect settings can cause a product malfunction.

11-1. Function settings by using remote controller

Some function settings can be changed on the remote controller. After confirming the setting procedure and the content of each function setting, select appropriate functions for your installation environment.

■ Setting procedure by using wireless remote controller

The function number and the associated setting value are displayed on the LCD of the remote controller. Follow the instructions written in the local setup procedure supplied with the remote controller, and select appropriate setting according to the installation environment.

Before connecting the power supply of the indoor unit, reconfirm following items:

- Cover for the electrical enclosure on the outdoor unit is in place.
- There is no wiring mistake.
- Piping air tight test and vacuuming have been performed firmly.
- All the necessary wiring work for outdoor unit has been finished.

After reconfirming the items listed above, connect the power supply of the indoor unit.

NOTES:

- Settings will not be changed if invalid numbers or setting values are selected.
- When optional wired remote controller is used, refer to the installation manual enclosed with the remote controller.

Entering function setting mode:

While pressing the POWERFUL button and TEMP. (^) button simultaneously, press the RESET button to enter the function setting mode.

Selecting the function number and setting value:

1. Press the TEMP. (^) (v) buttons to select the function number. To switch between the left and right digits, press the 10 °C HEAT button.
2. Press the POWERFUL button to proceed to value setting. To return the function number selection, press the POWERFUL button again.
3. Press the TEMP. (^) (v) buttons to select the setting value. To switch between the left and right digits, press the 10 °C HEAT button.
4. Press the MODE button once. Confirm that you hear the beep sound.
5. Press the START/STOP button to fix the function setting. Confirm that you hear the beep sound.
6. Press the RESET button to end the function setting mode.
7. After completing the function setting, be sure to disconnect the power supply and then reconnect it.

Function number
Setting value

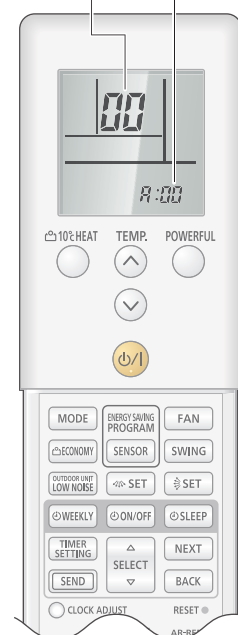

⚠ CAUTION

After disconnecting the power supply, wait 30 seconds or more before reconnecting it. The function setting will not become active unless the power supply is disconnected and then reconnected.

NOTES:

- The air conditioner custom code is set to \overline{H} prior to shipment.
- If you do not know the air conditioner custom code setting, try each of the custom codes ($\overline{H} \rightarrow \overline{b}$ $\rightarrow \overline{c} \rightarrow \overline{d}$) until you find the code that operates the air conditioner.

■ Contents of function setting

Each function setting listed in this section is adjustable in accordance with the installation environment.

NOTE: Setting will not be changed if invalid numbers or setting values are selected.

● Function setting list

	Function no.	Functions
1)	11	Filter sign
2)	30	Room temperature sensor control for cooling
3)	31	Room temperature sensor control for heating
4)	40	Auto restart
5)	42	Room temperature sensor switching
6)	44	Remote controller custom code
7)	46	External input control
8)	48	Room temperature sensor switching (Aux.)
9)	49	Indoor unit fan control for energy saving for cooling

1) Filter sign

Select appropriate intervals for displaying the filter sign on the indoor unit according to the estimated amount of dust in the air of the room.

If the indication is not required, select "No indication" (03).

Function number	Setting value	Setting description	Factory setting
11	00	Standard (400 hours)	
	01	Long interval (1,000 hours)	
	02	Short interval (200 hours)	
	03	No indication	◆

2) Room temperature sensor control for cooling

Depending on the installed environment, correction of the room temperature sensor may be required. Select the appropriate control setting according to the installed environment.

Function number	Setting value	Setting description	Factory setting
30	00	Standard	◆
	01	Slightly lower control	
	02	Lower control	
	03	Higher control	

3) Room temperature sensor control for heating

Depending on the installed environment, correction of the room temperature sensor may be required. Select the appropriate control setting according to the installed environment.

Function number	Setting value	Setting description	Factory setting
31	00	Standard	◆
	01	Lower control	
	02	Slightly higher control	
	03	Higher control	

4) Auto restart

Enables or disables automatic restart after a power interruption.

Function number	Setting value	Setting description	Factory setting
40	00	Enable	◆
	01	Disable	

NOTE: Auto restart is an emergency function such as for power outage etc. Do not attempt to use this function in normal operation. Be sure to operate the unit by remote controller or external device.

5) Room temperature sensor switching

When using the wired remote controller temperature sensor, change the setting to "Both" (01).

Function number	Setting value	Setting description	Factory setting
42	00	Indoor unit	◆
	01	Both	

00: Sensor on the indoor unit is active.

01: Sensors on both indoor unit and wired remote controller are active.

NOTE: Remote controller sensor must be turned on by using the remote controller.

6) Remote controller custom code

(Only for wireless remote controller)

The indoor unit custom code can be changed. Select the appropriate custom code.

Function number	Setting value	Setting description	Factory setting
44	00	A	◆
	01	B	
	02	C	
	03	D	

7) External input control

"Operation/Stop" mode or "Forced stop" mode can be selected.

Function number	Setting value	Setting description	Factory setting
46	00	Operation/Stop mode	◆
	01	(Setting prohibited)	
	02	Forced stop mode	

8) Room temperature sensor switching (Aux.)

To use the temperature sensor on the wired remote controller only, change the setting to "Wired remote controller" (01).

This function will only work if the function setting 42 is set at "Both" (01).

When the setting value is set to "Both" (00), more suitable control of the room temperature is possible by setting function setting 30 and 31 too.

Function number	Setting value	Setting description	Factory setting
48	00	Both	◆
	01	Wired remote controller	

9) Indoor unit fan control for energy saving for cooling

Enables or disables the power-saving function by controlling the indoor unit fan rotation when the outdoor unit is stopped during cooling operation.

Function number	Setting value	Setting description	Factory setting
49	00	Disable	
	01	Enable	◆

00: When the outdoor unit is stopped, the indoor unit fan operates continuously following the setting on the remote controller.

01: When the outdoor unit is stopped, the indoor unit fan operates intermittently at a very low speed.

11-2. Custom code setting for wireless remote controller

To interconnect the air conditioner and the wireless remote controller, assignment of the custom code for the wireless remote controller is required.

NOTE: Air conditioner cannot receive a signal if the air conditioner has not been set for the custom code.

When 2 or more air conditioners are installed in a room, and the remote controller is operating an air conditioner other than the one you wish to set, change the custom code of the remote controller to operate only the air conditioner you wish to set. (4 selections possible.)

Confirm the setting of the remote controller custom code and the function setting. If these do not match, the remote controller cannot be used to operate for the air conditioner.

1. Press the START/STOP button until only the clock is displayed on the remote controller display.
2. Press the MODE button for at least 5 seconds to display the current custom code. (Initially set to A .)
3. Press the TEMP. (\wedge) (\vee) buttons to change the custom code between $\text{A} \rightarrow \text{B} \rightarrow \text{C} \rightarrow \text{D}$. Match the code on the display to the air conditioner custom code. (Initially set to A .)
4. Press the MODE button again to return to the clock display. The custom code will be changed.









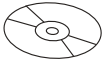
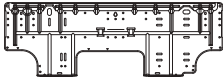

NOTES:

- If no button is pressed within 30 seconds after the custom code is displayed, the system returns to the original clock indicator. In this case, start again from step 1.
- The air conditioner custom code is set to A prior to shipment. To change the custom code, contact your retailer.
- If you do not know the assigned code for the air conditioner, try each of the custom code ($\text{A} \rightarrow \text{B} \rightarrow \text{C} \rightarrow \text{D}$) until you find the code which operates the air conditioner.

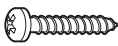
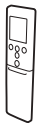

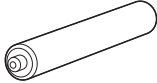
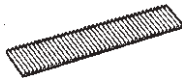
12. Accessories

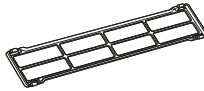
12-1. Models: ASYG09KHCA, ASYG12KHCA, and ASYG14KHCA

Part name	Exterior	Q'ty	Part name	Exterior	Q'ty
Operating manual		1	Cloth tape		1
Operating manual (CD-ROM)		1	Wall hook bracket		1
Installation manual		1	Tapping screw (large)		5
Remote controller		1	Tapping screw (small)		2
Battery		2	Air cleaning filter		2
Remote controller holder		1	Filter holder		2

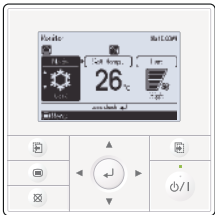
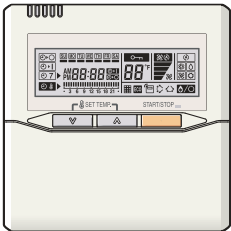

13. Optional parts

13-1. Controllers

Exterior	Part name	Model name	Summary
	Wired remote controller	UTY-RVNYM	Large and full-dot liquid crystal screen, wide and large keys easy to press, user-intuitive arrow key. Wire type: Polar 3-wire Optional communication kit is necessary for installation.
	Wired remote controller	UTY-RNNYM	Room temperature can be controlled by detecting the temperature accurately with built-in thermo sensor. Wire type: Polar 3-wire Optional communication kit is necessary for installation.
	Simple remote controller	UTY-RSNYM	Compact remote controller concentrates on the basic functions such as Start/Stop, fan control, temperature setting, and operation mode. Wire type: Polar 3-wire Optional communication kit is necessary for installation.

NOTE: Available functions may differ by the remote controller. For details, refer to the operation manual.

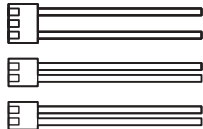
13-2. Others

Exterior	Part name	Model name	Summary
	External connect kit	UTY-XWZXZ5	Required when external device is connected.
	Communication kit	UTY-TWBXF1	Use to connect with optional devices and air conditioner PCB. Optional External connect kit is necessary for installation.
	Wireless LAN adapter	UTY-TFNXZ1	Remotely manage an air conditioning system using mobile devices such as smartphones and tablets.

Part 2. OUTDOOR UNIT

SINGLE TYPE:

AOYG09KHCAN

AOYG12KHCAN

AOYG14KHCAN

1. Specifications

OUTDOOR UNIT
AOYG09-14KHCAN

OUTDOOR UNIT
AOYG09-14KHCAN

Type			Inverter heat pump		
Model name			AOYG09KHCAN	AOYG12KHCAN	AOYG14KHCAN
Power supply			230 V ~ 50 Hz		
Power supply intake			Outdoor unit		
Available voltage range			198—264 V		
Starting current			A	2.7	3.6
Fan	Airflow rate	Cooling	m ³ /h	1,810	2,050
		Heating		1,550	1,780
	Type × Q'ty			Propeller fan × 1	
Motor output			W	49	
Sound pressure level *	Cooling	Heating	dB (A)	43	47
				42	45
Sound power level	Cooling	Heating	dB (A)	56	60
				55	58
Heat exchanger type	Dimensions (H × W × D)		mm	Main1: 588 × 881 × 18.2	
	Fin pitch			Main2: 588 × 851 × 18.2	
	Rows × Stages		Main1: 1.3		
	Pipe type		Main2: 1.3		
	Fin type		Type (Material)	1 × 28	
		Surface treatment	Copper		
			Corrugate (Aluminum)		
			PC fin		
Compressor	Type × Q'ty		W	DC rotary × 1	
	Motor output			810	900
Refrigerant	Type (Global warming potential)		R32 (675)		
	Charge		g		
Refrigerant oil	Type		FW68S		
	Amount		cm ³		
Enclosure	Material		Steel sheet		
	Color		Beige		
Dimensions (H × W × D)	Net		mm	Approximate color of Munsell 10YR 7.5/1.0	
	Gross			620 × 790 × 290	
Weight	Net		kg	713 × 945 × 395	
	Gross			36	
Connection pipe	Size	Liquid	mm (in)	Ø 6.35 (Ø 1/4)	
		Gas		Ø 9.52 (Ø 3/8)	
	Method		Flare		
	Pre-charge length		m	15	
	Max. length			20	
Max. height difference		15			
Operation range	Cooling		°C	-10 to 46	
	Heating			-25 to 24	
NOTES:					
<ul style="list-style-type: none"> • Specifications are based on the following conditions: <ul style="list-style-type: none"> – Cooling: Indoor temperature of 27 °CDB/ 19 °CWB, and outdoor temperature of 35 °CDB/ 24 °CWB. – Heating: Indoor temperature of 20 °CDB/ 15 °CWB, and outdoor temperature of 7 °CDB/ 6 °CWB. – Pipe length: 5 m, Height difference: 0 m. • Protective function might work when using it outside the operation range. • *: Sound pressure level <ul style="list-style-type: none"> – Measured values in manufacturer's anechoic chamber. – Because of the surrounding sound environment, the sound levels measured in actual installation conditions might be higher than the specified values here. 					

2. Dimensions

2-1. Models: AOYG09KHCAN, AOYG12KHCAN, and AOYG14KHCAN

OUTDOOR UNIT
AOYG09-14KHCAN

OUTDOOR UNIT
AOYG09-14KHCAN

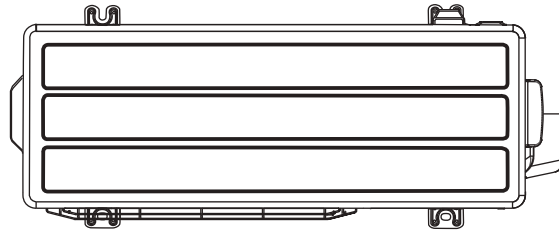

Top view

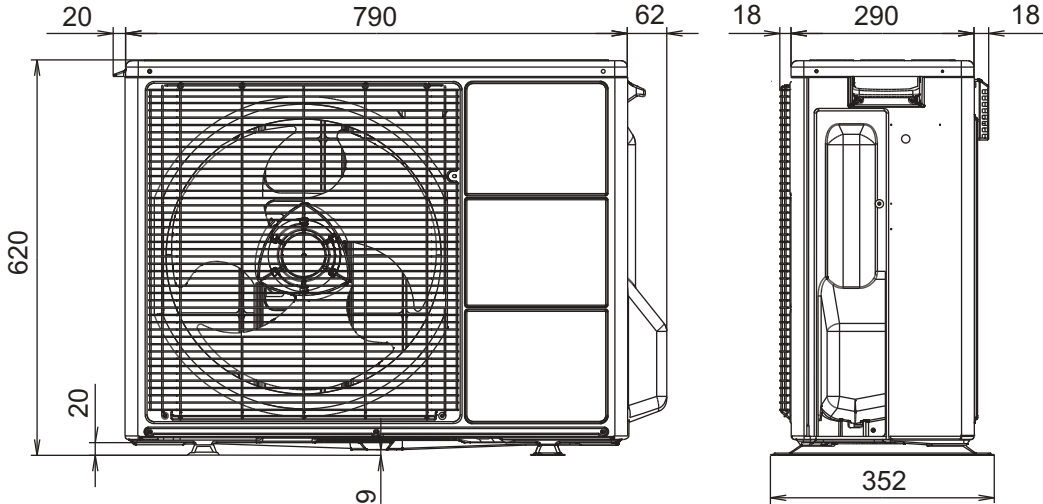

Front view

Side view

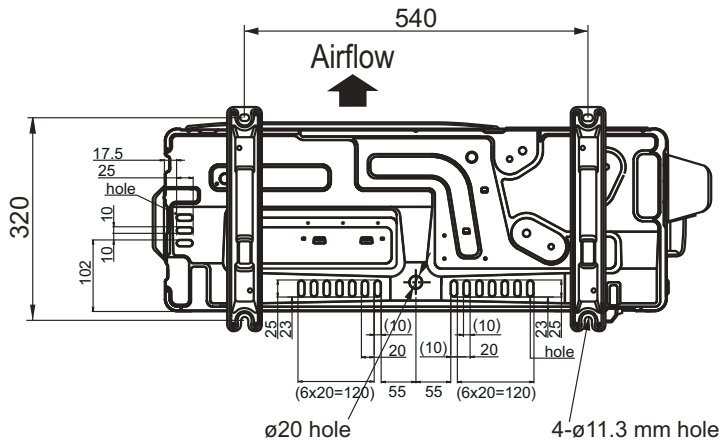

Bottom view

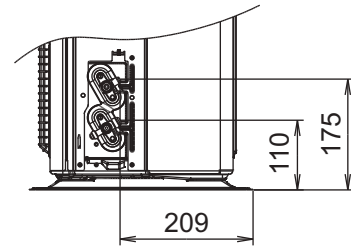

3. Installation space

3-1. Models: AOYG09KHCAN, AOYG12KHCAN, and AOYG14KHCAN

■ Space requirement

Provide sufficient installation space for product safety.

● Single outdoor unit installation

- When the upper space is open:

Unit: mm

When there are obstacles at the rear only.

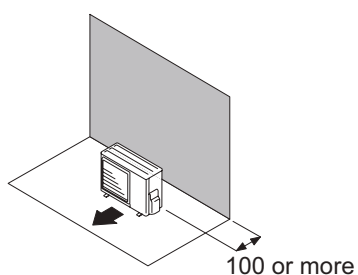

When there are obstacles at the rear and sides.

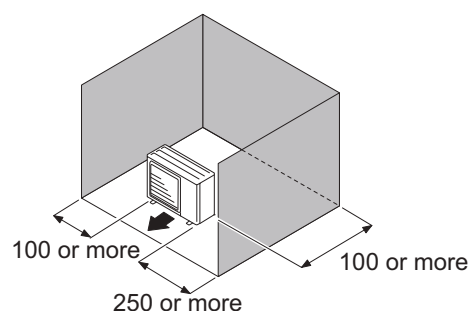

When there are obstacles at the front only.

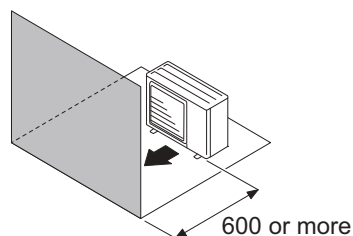

When there are obstacles at the front and rear.

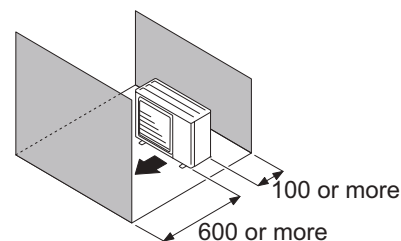

- When there is an obstruction in the upper space:

Unit: mm

When there are obstacles at the rear and above.

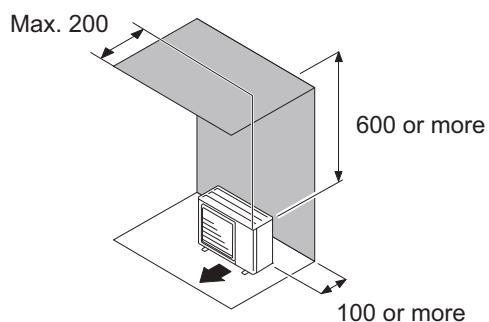

When there are obstacles at the rear, sides, and above.

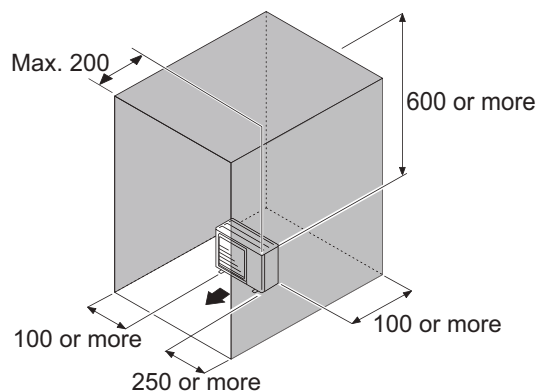

● Multiple outdoor unit installation

- When the upper space is open:

Unit: mm

When there are obstacles at the rear only.

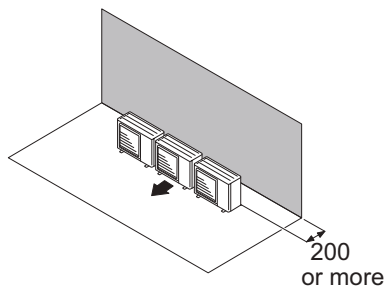

When there are obstacles at the front only.

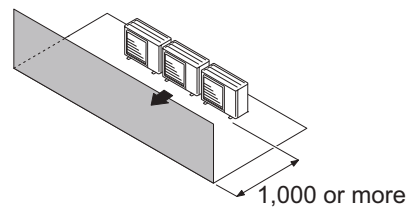

When there are obstacles at the front and rear.

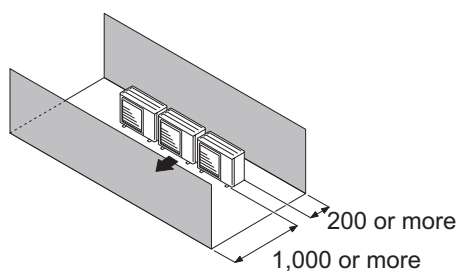

- When there is an obstruction in the upper space:

Unit: mm

When there are obstacles at the rear and above.

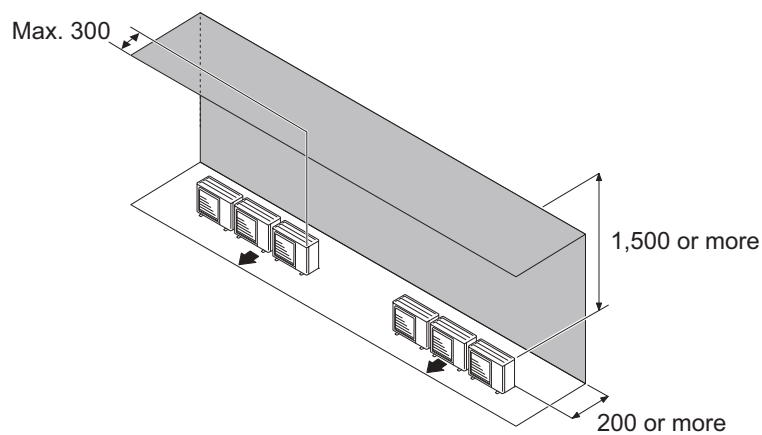

● Outdoor unit installation in multi-row

Unit: mm

Single parallel unit arrangement

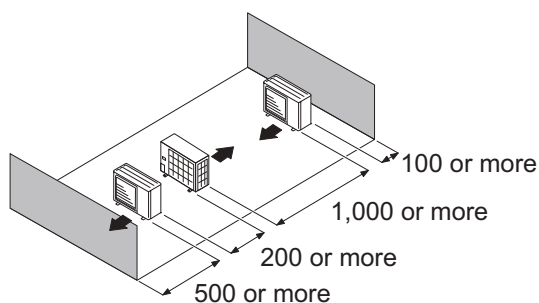

Multiple parallel unit arrangement

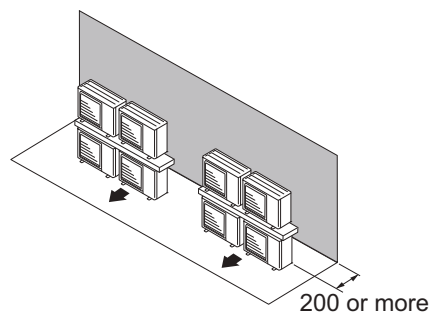
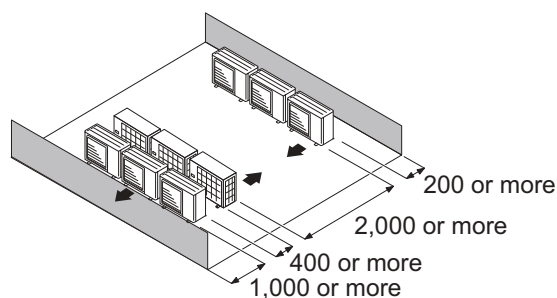

NOTES:

- If the space is larger than stated above, the condition will be the same as when there is no obstacle.
- Height above the floor level should be 50 mm or more.
- When installing the outdoor unit, be sure to open the front and left side to obtain better operation efficiency.

⚠ CAUTION

- Do not install the outdoor unit in two-stage where the drain water could freeze. Otherwise the drainage from the upper unit may form ice and cause a malfunction of the lower unit.
- When the outdoor temperature is 0 °C or less, do not use the accessory drain pipe and drain cap. If the drain pipe and drain cap are used, the drain water in the pipe may freeze in extremely cold climate. (For reverse cycle model only.)
- In area with heavy snowfall, if the inlet and outlet of the outdoor unit is blocked with snow, it might become difficult to get warm, and it is likely to cause product malfunction. Construct a canopy and a pedestal, or place the unit on a high stand that is locally installed.

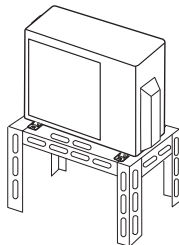

4. Refrigerant circuit

4-1. Models: AOYG09KHCAN, AOYG12KHCAN, and AOYG14KHCAN

OUTDOOR UNIT
AOYG09-14KHCAN

OUTDOOR UNIT
AOYG09-14KHCAN

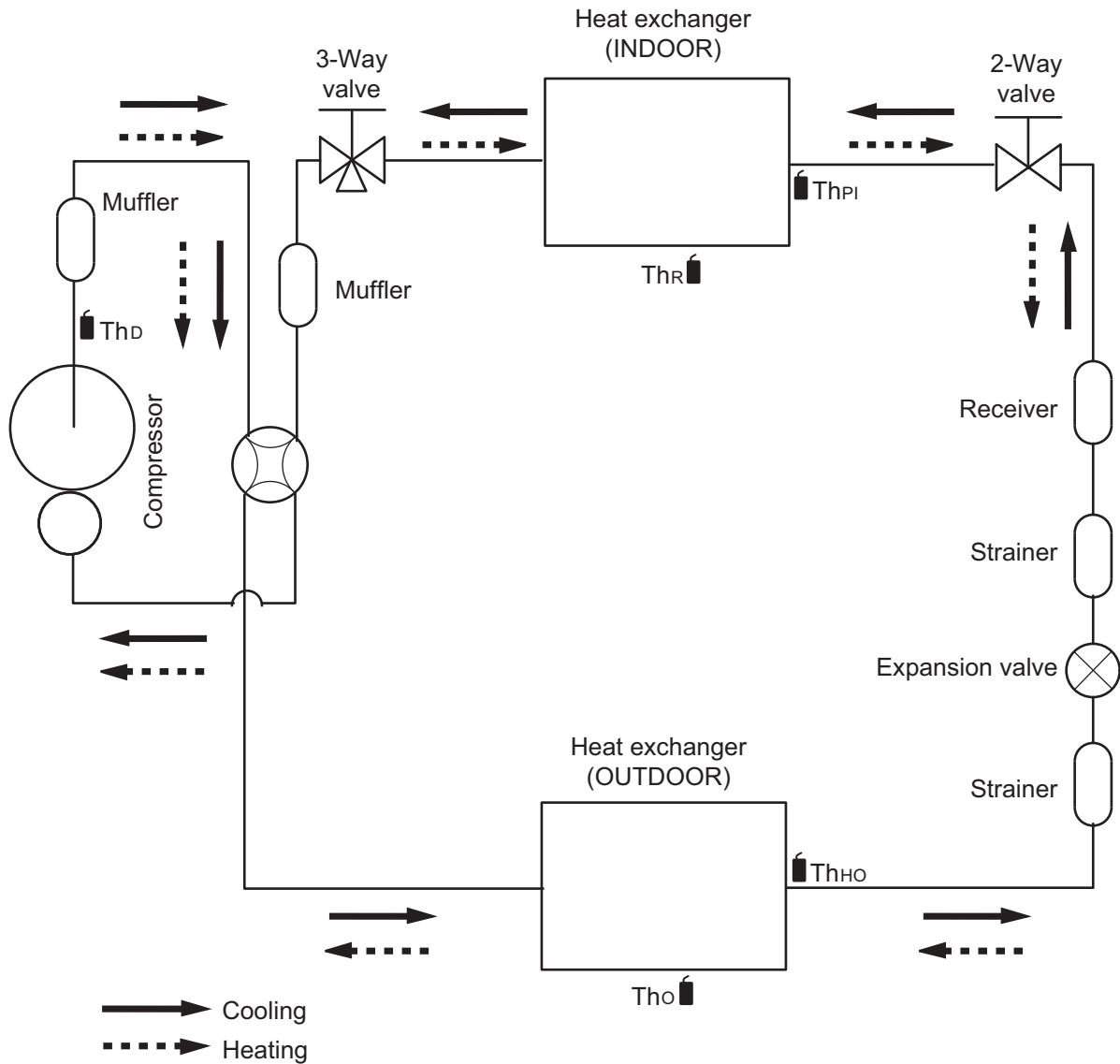

- Th_D : Thermistor (Discharge temp.)
- Th_O : Thermistor (Outdoor temp.)
- Th_{HO} : Thermistor (Heat exchanger out temp.)
- Th_R : Thermistor (Room temp.)
- Th_{PI} : Thermistor (Pipe temp.)

5. Wiring diagrams

5-1. Models: AOYG09KHCAN, AOYG12KHCAN, and AOYG14KHCAN

OUTDOOR UNIT
AOYG09-14KHCAN

OUTDOOR UNIT
AOYG09-14KHCAN

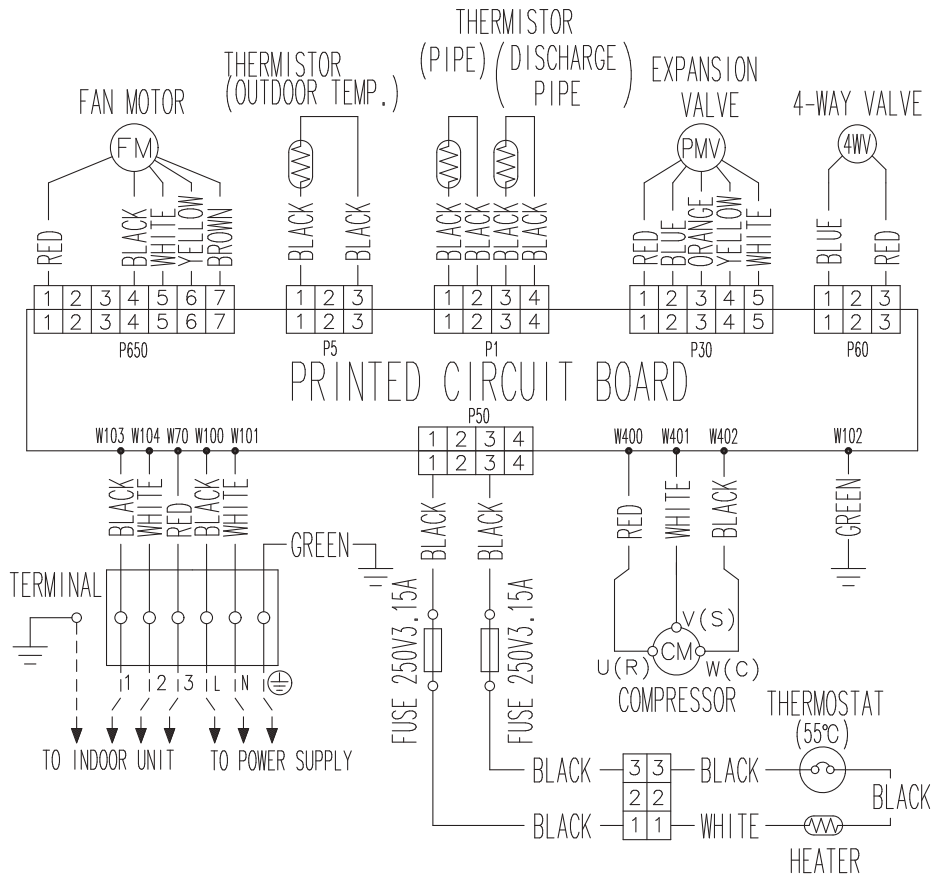

6. Capacity compensation rate for pipe length and height difference

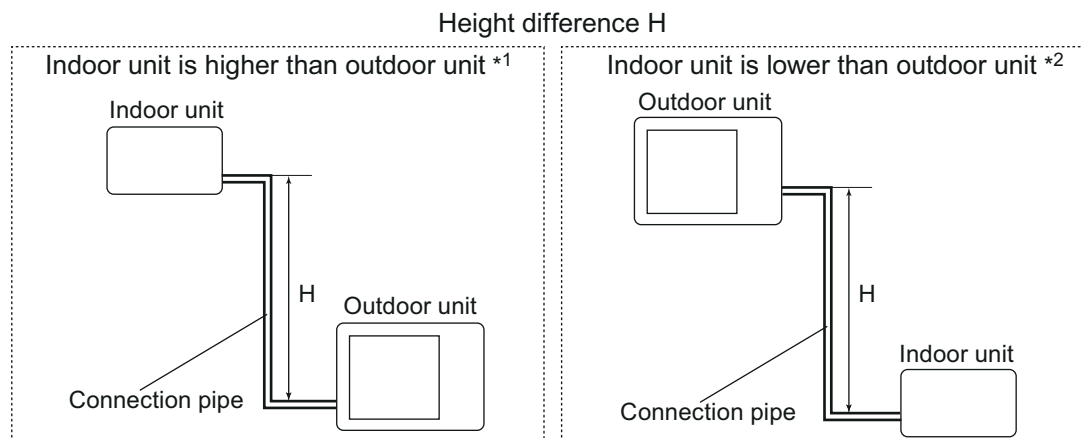

6-1. Model: AOYG09KHCAN

NOTE: Values mentioned in the table are calculated based on the maximum capacity.

COOLING			Pipe length (m)				
			5	7.5	10	15	20
Height difference H (m)	Indoor unit is higher than outdoor unit *1	15	—	—	—	0.913	0.922
		10	—	—	0.963	0.928	0.937
		7.5	—	0.980	0.967	0.932	0.941
		5	0.992	0.984	0.971	0.936	0.945
	0	1.000	0.992	0.979	0.943	0.953	
	Indoor unit is lower than outdoor unit *2	-5	1.000	0.992	0.979	0.943	0.953
		-7.5	—	0.992	0.979	0.943	0.953
		-10	—	—	0.979	0.943	0.953
		-15	—	—	—	0.943	0.953

HEATING			Pipe length (m)				
			5	7.5	10	15	20
Height difference H (m)	Indoor unit is higher than outdoor unit *1	15	—	—	—	0.990	0.969
		10	—	—	1.002	0.990	0.969
		7.5	—	1.001	1.002	0.990	0.969
		5	1.000	1.001	1.002	0.990	0.969
		0	1.000	1.001	1.002	0.990	0.969
	Indoor unit is lower than outdoor unit *2	-5	0.995	0.996	0.997	0.985	0.964
		-7.5	—	0.994	0.995	0.983	0.962
		-10	—	—	0.992	0.980	0.960
		-15	—	—	—	0.970	0.950

6-2. Model: AOYG12KHCAN

NOTE: Values mentioned in the table are calculated based on the maximum capacity.

COOLING			Pipe length (m)				
			5	7.5	10	15	20
Height difference H (m)	Indoor unit is higher than outdoor unit *1	15	—	—	—	0.882	0.880
		10	—	—	0.943	0.896	0.894
		7.5	—	0.968	0.947	0.900	0.898
		5	0.992	0.972	0.951	0.903	0.901
	Indoor unit is lower than outdoor unit *2	0	1.000	0.980	0.958	0.911	0.909
		-5	1.000	0.980	0.958	0.911	0.909
		-7.5	—	0.980	0.958	0.911	0.909
		-10	—	—	0.958	0.911	0.909
		-15	—	—	—	0.911	0.909

HEATING			Pipe length (m)				
			5	7.5	10	15	20
Height difference H (m)	Indoor unit is higher than outdoor unit *1	15	—	—	—	0.952	0.932
		10	—	—	1.002	0.952	0.932
		7.5	—	1.010	1.002	0.952	0.932
		5	1.000	1.010	1.002	0.952	0.932
		0	1.000	1.010	1.002	0.952	0.932
	Indoor unit is lower than outdoor unit *2	-5	0.995	1.005	0.997	0.947	0.927
		-7.5	—	1.002	0.994	0.945	0.925
		-10	—	—	0.992	0.942	0.923
		-15	—	—	—	0.933	0.913

6-3. Model: AOYG14KHCAN

NOTE: Values mentioned in the table are calculated based on the maximum capacity.

COOLING			Pipe length (m)				
			5	7.5	10	15	20
Height difference H (m)	Indoor unit is higher than outdoor unit *1	15	—	—	—	0.866	0.869
		10	—	—	0.926	0.867	0.876
		7.5	—	0.959	0.929	0.871	0.880
		5	0.992	0.963	0.933	0.874	0.883
	Indoor unit is lower than outdoor unit *2	0	1.000	0.970	0.941	0.881	0.890
		-5	1.000	0.970	0.941	0.881	0.890
		-7.5	—	0.970	0.941	0.881	0.890
		-10	—	—	0.941	0.881	0.890
		-15	—	—	—	0.881	0.890

HEATING			Pipe length (m)				
			5	7.5	10	15	20
Height difference H (m)	Indoor unit is higher than outdoor unit *1	15	—	—	—	0.956	0.938
		10	—	—	1.004	0.956	0.938
		7.5	—	1.013	1.004	0.956	0.938
		5	1.000	1.013	1.004	0.956	0.938
		0	1.000	1.013	1.004	0.956	0.938
	Indoor unit is lower than outdoor unit *2	-5	0.995	1.008	0.999	0.951	0.933
		-7.5	—	1.005	0.997	0.948	0.931
		-10	—	—	0.994	0.946	0.929
		-15	—	—	—	0.937	0.919

7. Additional charge calculation

7-1. Models: AOYG09KHCAN, AOYG12KHCAN, and AOYG14KHCAN

Refrigerant type		R32
Factory charge amount	g	1,100

■ Refrigerant charge

Total pipe length	m	15 or less	20 (Max.)	20 g/m
Additional charge amount	g	0	100	

8. Airflow

8-1. Model: AOYG09KHCAN

● Cooling

m ³ /h	1,810
l/s	503
CFM	1,065

● Heating

m ³ /h	1,550
l/s	431
CFM	912

8-2. Model: AOYG12KHCAN

● Cooling

m ³ /h	2,050
l/s	569
CFM	1,207

● Heating

m ³ /h	1,780
l/s	494
CFM	1,048

8-3. Model: AOYG14KHCAN

● Cooling

m ³ /h	2,460
l/s	683
CFM	1,448

● Heating

m ³ /h	1,780
l/s	431
CFM	912

9. Operation noise (sound pressure)

9-1. Noise level curve

Model: AOYG09KHCAN

● Cooling

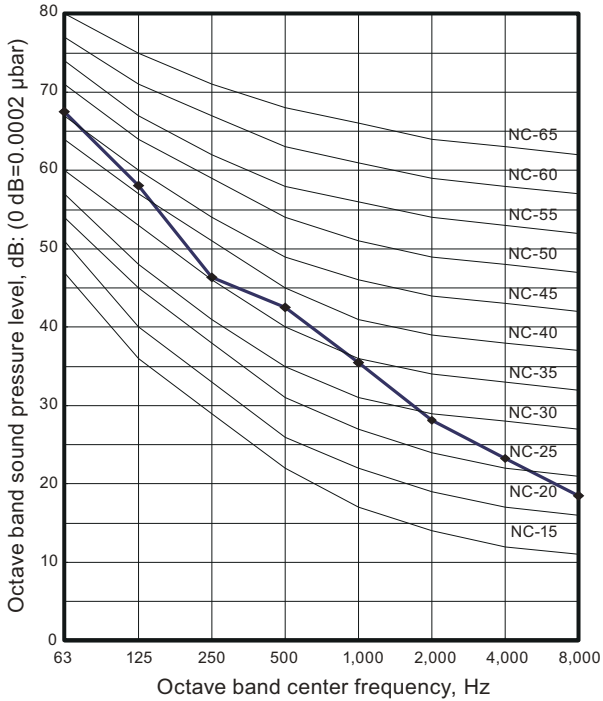

● Heating

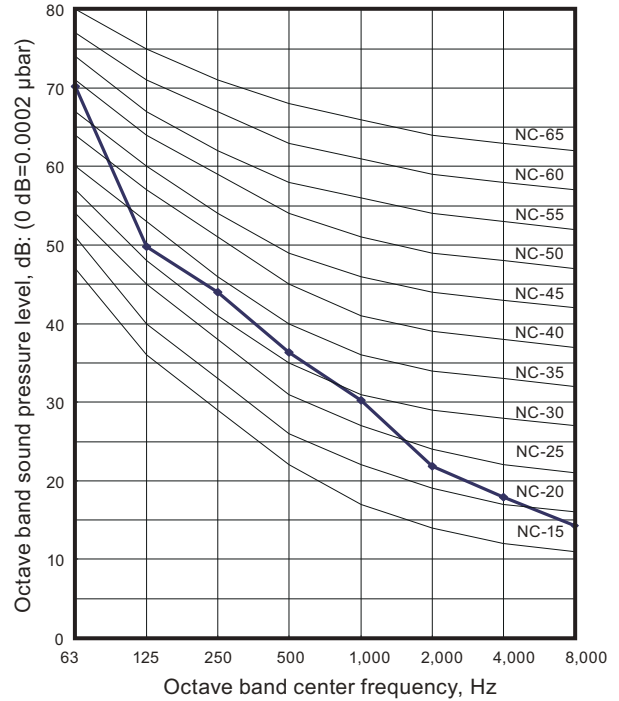

Model: AOYG12KHCAN

● Cooling

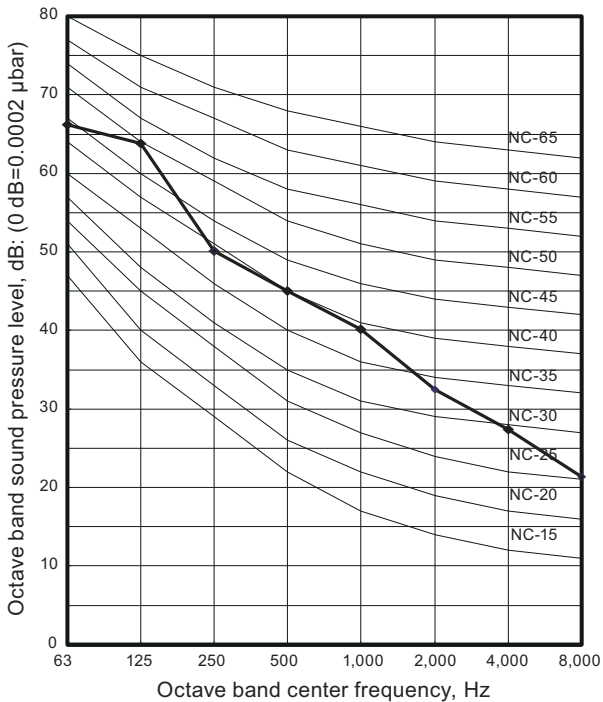

● Heating

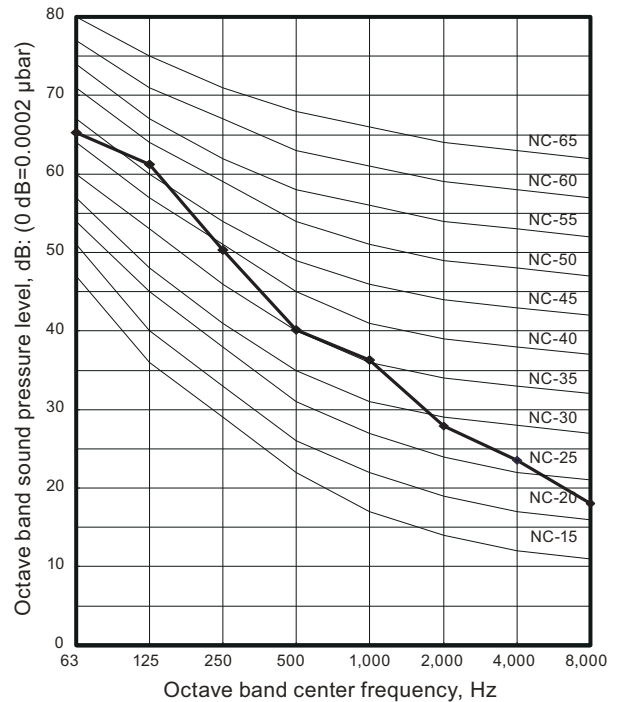

OUTDOOR UNIT
AOYG09-14KHCAN

OUTDOOR UNIT
AOYG09-14KHCAN

Model: AOYG14KHCAN

OUTDOOR UNIT
AOYG09-14KHCAN

OUTDOOR UNIT
AOYG09-14KHCAN

● Cooling

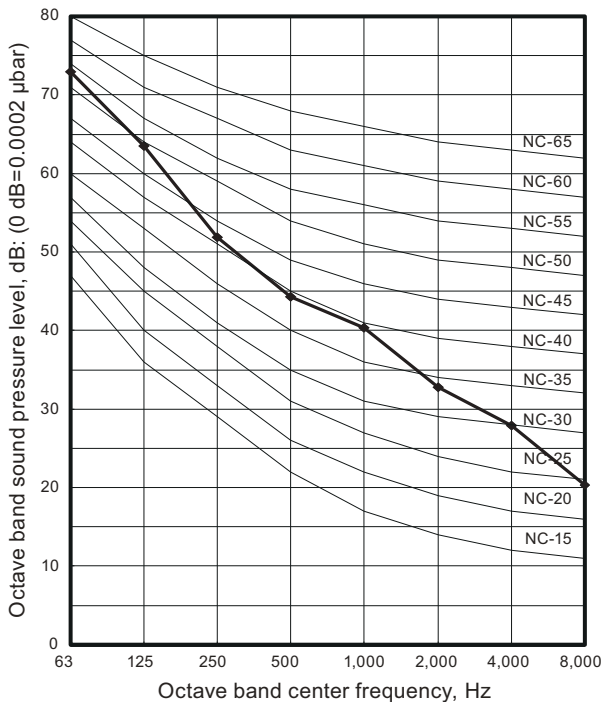

● Heating

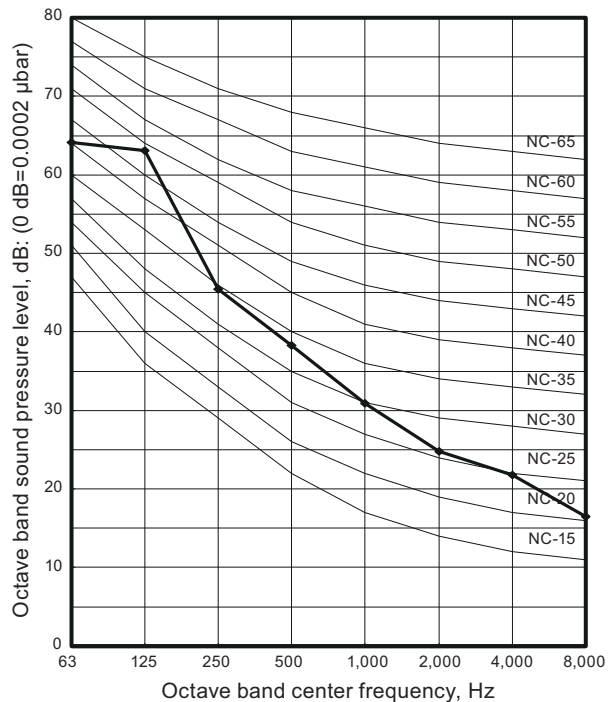

9-2. Sound level check point

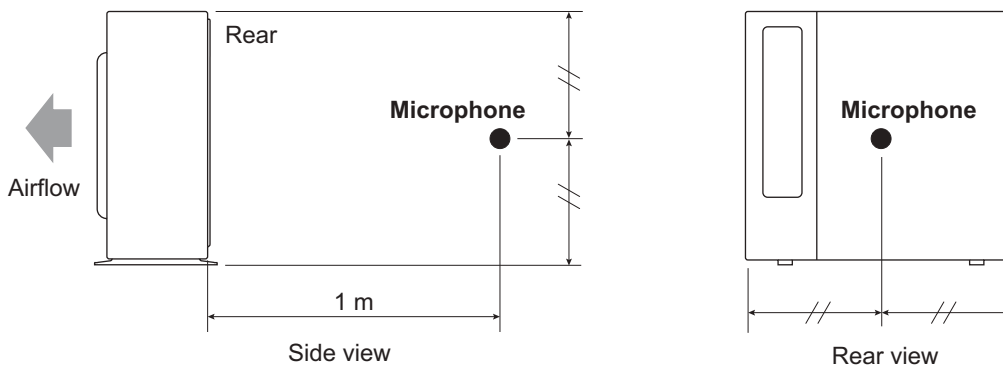

NOTE: Detailed shape of the actual outdoor unit might be slightly different from the one illustrated above.

10. Electrical characteristics

Model name			AOYG09KHCAN	AOYG12KHCAN	AOYG14KHCAN
Power supply	Voltage	V	230~		
	Frequency	Hz	50		
Max operating current *1		A	10.5	11.0	11.5
Starting current		A	2.7	3.6	5.2
Wiring spec. *2	Circuit breaker current		A	15	
	Power cable		mm ²	1.5	
	Connection cable *3	Cross-sectional area	mm ²	1.5	
		Limited wiring length	m	21	

*1: Maximum operating current is the total current of the indoor unit and the outdoor unit.

*2: Selected sample based on Japan Electrotechnical Standards and Codes Committee E0005. As the regulations of wire size and circuit breaker differ in each country or region, select appropriate devices complied to the regional standard.

*3: Limit voltage drop to less than 2%. If voltage drop is 2% or more, increase cable conductor size.

11. Safety devices

Type of protection	Protection form		Model		
			AOYG09KHCAN	AOYG12KHCAN	AOYG14KHCAN
Circuit protection	Current fuse (Main PCB)		250 V, 25 A		
			250 V, 5 A		
			250 V, 3.15 A		
	Current fuse (Wire)		250 V, 3.15 A		
Fan motor protection	Thermal protection program	Activate	125 ±10 °C Fan motor stop		
		Reset	120 ±10 °C Fan motor restart		
Compressor protection	Thermal protection program (Discharge temp.)	Activate	110 °C Compressor stop		
		Reset	After 7 minutes Compressor restart		
	Thermal protection program (Outdoor temp.) (Only in COOL or DRY mode)	Activate	-15 °C Compressor stop		
		Reset	-10 °C Compressor restart		

12. Accessories

12-1. Models: AOYG09KHCAN, AOYG12KHCAN, and AOYG14KHCAN

Part name	Exterior	Q'ty	Part name	Exterior	Q'ty
Installation manual		1			