

AIR CONDITIONER

Multi: 5, 6 rooms type

DESIGN & TECHNICAL MANUAL

INDOOR



AUYG07LVLA
AUYG09LVLA
AUYG12LVLB
AUYG14LVLB
AUYG18LVLB



ARYG07LSLAP
ARYG09LSLAP
ARYG12LSLAP
ARYG14LSLAP



ARYG18LSLAP



ARYG07LLTA
ARYG09LLTA
ARYG12LLTB
ARYG14LLTB



ARYG18LLTB



ASYG07LMCA
ASYG09LMCA
ASYG12LMCA
ASYG14LMCA



ASYG07LMCE
ASYG09LMCE
ASYG12LMCE
ASYG14LMCE



ASYG07LUCA
ASYG09LUCA
ASYG12LUCA
ASYG14LUCA



ASYG18LFCA
ASYG24LFCA
ASYG24LFCC



ABYG14LVTA
ABYG18LVTB

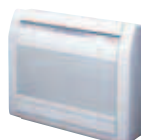

AGYG09LVCA
AGYG12LVCA
AGYG14LVCA

OUTDOOR



AOYG36LBLA5
AOYG45LBLA6

FUJITSU GENERAL LIMITED

Notices:

- Product specifications and design are subject to change without notice for future improvement.
- For further details, please check with our authorized dealer.

CONTENTS

Part 1. INDOOR UNIT.....1

1. Model lineup	2
1-1. Connectable indoor units to each outdoor unit.....	3
1-2. Indoor unit connection patterns.....	4
2. Specifications	9
2-1. Compact cassette type	9
2-2. Mini duct type.....	11
2-3. Slim duct type	13
2-4. Wall mounted type	15
2-5. Floor/Ceiling type	19
2-6. Floor type.....	20
3. Dimensions.....	21
3-1. Compact cassette type	21
3-2. Mini duct type.....	23
3-3. Slim duct type	26
3-4. Wall mounted type	30
3-5. Floor/Ceiling type	38
3-6. Floor type.....	40
4. Wiring diagrams	41
4-1. Compact cassette type	41
4-2. Mini duct type.....	42
4-3. Slim duct type	43
4-4. Wall mounted type	44
4-5. Floor/Ceiling type	47
4-6. Floor type.....	48
5. Air velocity and temperature distributions	49
5-1. Compact cassette type	49
5-2. Mini duct type.....	57
5-3. Slim duct type	67
5-4. Wall mounted type	77
5-5. Floor/Ceiling type	85
5-6. Floor type.....	89
6. Fan performance	90
6-1. Mini duct type.....	90
6-2. Slim duct type	100
7. Airflow.....	110
7-1. Compact cassette type	110
7-2. Mini duct type.....	111
7-3. Slim duct type	112
7-4. Wall mounted type	113
7-5. Floor/Ceiling type	115

CONTENTS (continued)

7-6. Floor type	115
8. Noise level curve	116
8-1. Compact cassette type	116
8-2. Mini duct type	119
8-3. Slim duct type	122
8-4. Wall mounted type	125
8-5. Floor/Ceiling type	130
8-6. Floor type	131
8-7. Sound level check point	133
9. Electrical characteristics	136
10. Safety devices	137
11. External input and output	138
11-1. Compact cassette, slim duct, wall mounted, floor/ceiling, and floor types	138
11-2. Mini duct type	148
12. Group connection	154
12-1. Precautions on creating a group connection	155
12-2. Remote controller address setting procedure for wireless remote controllers	157
13. Remote controller	158
13-1. Wireless remote controller (AR-RAH2E/AR-RAH1E)	158
13-2. Wireless remote controller (AR-REA2E/AR-REB1E)	161
13-3. IR receiver kit with Wireless remote controller (UTY-LRHYM: Optional part)	164
13-4. IR receiver kit with Wireless remote controller (UTY-LBTYM: Optional part)	167
13-5. Wired remote controller (UTY-RNNYM)	170
13-6. Wired remote controller (UTY-RLRY)	175
13-7. Wired remote controller (UTY-RVNYM: Optional part)	178
13-8. Wired remote controller (UTY-RNRYZ*: Optional part)	187
13-9. Simple remote controller (UTY-RSNYM: Optional part)	190
13-10. Simple remote controller (UTY-RSRY and UTY-RHRY: Optional parts)	195
14. Function settings	198
14-1. Compact cassette, slim duct, and floor/ceiling types indoor unit (setting by DIP switch and jumper wire)	198
14-2. Mini duct type indoor unit (setting by DIP switch)	200
14-3. Indoor unit (setting by wireless remote controller)	202
14-4. Indoor unit (setting by wired remote controller)	223
14-5. Indoor unit (setting by simple remote controller)	234
14-6. Function details	241
14-7. Wired remote controller (UTY-RNNYM)	249
14-8. Wired remote controller (UTY-RVNYM)	251
14-9. Wired remote controller (UTY-RLRY)	252
14-10. Wired remote controller (UTY-RNRYZ*)	253
14-11. Simple remote controller (UTY-RSNYM)	254
15. Accessories	255
15-1. Compact cassette type	255

CONTENTS (continued)

15-2. Mini duct type	256
15-3. Slim duct type	257
15-4. Wall mounted type	258
15-5. Floor/Ceiling type	261
15-6. Floor type	262
16. Optional parts	263
16-1. Controllers	263
16-2. Cassette grille	265
16-3. Others	266
17. Indoor unit installation precautions	269
17-1. Places where prohibited for use	269
17-2. Points to remember when installing	270

CONTENTS (continued)

Part 2. OUTDOOR UNIT (5 ROOMS TYPE)	273
1. Specifications	274
2. Dimensions	276
2-1. Model: AOYG36LBLA5	276
3. Installation space	277
3-1. Model: AOYG36LBLA5	277
4. Refrigerant circuit	280
4-1. Model: AOYG36LBLA5	280
5. Wiring diagram	281
5-1. Model: AOYG36LBLA5	281
6. Capacity table	282
6-1. Combinations	282
6-2. Cooling capacity	287
6-3. Heating capacity	302
7. Capacity compensation rate for pipe length and height difference	316
7-1. Model: AOYG36LBLA5	316
8. Additional charge calculation	320
8-1. Model: AOYG36LBLA5	320
9. Airflow	321
9-1. Model: AOYG36LBLA5	321
10. Operation noise (sound pressure)	322
10-1.Noise level curve.....	322
10-2.Sound level check point	322
11. Electrical characteristics	323
12. Safety devices	324
13. Function settings	325
13-1.Setting methods	325
13-2.Outdoor unit low noise operation function (option)	328
13-3.Changing the current limit function.....	328
14. Check and test	329
14-1.Check run	329
14-2.Test run.....	335
14-3.Error code	336
14-4.Pump down.....	339
15. Accessories	341
16. Optional parts	342
17. Outdoor unit installation precautions	343
17-1.Places where prohibited for use.....	343
17-2.Points to remember when installing	343

CONTENTS (continued)

Part 3. OUTDOOR UNIT (6 ROOMS TYPE)	345
1. Specifications	346
2. Dimensions	347
2-1. Model: AOYG45LBLA6	347
3. Installation space	348
3-1. Model: AOYG45LBLA6	348
4. Refrigerant circuit	351
4-1. Model: AOYG45LBLA6	351
5. Wiring diagram	352
5-1. Model: AOYG45LBLA6	352
6. Capacity table	353
6-1. Combinations	353
6-2. Cooling capacity	361
6-3. Heating capacity	376
7. Capacity compensation rate for pipe length and height difference	390
7-1. Model: AOYG45LBLA6	390
8. Additional charge calculation	394
8-1. Model: AOYG45LBLA6	394
9. Airflow	395
9-1. Model: AOYG45LBLA6	395
10. Operation noise (sound pressure)	396
10-1.Noise level curve.....	396
10-2.Sound level check point	396
11. Electrical characteristics	397
12. Safety devices	398
13. Function settings	399
13-1.Setting methods	399
13-2.Outdoor unit low noise operation function (option)	402
13-3.Changing the current limit function.....	402
14. Check and test	403
14-1.Check run	403
14-2.Test run.....	409
14-3.Error code	410
14-4.Pump down.....	413
15. Accessories	415
16. Optional parts	416
17. Outdoor unit installation precautions	417
17-1.Places where prohibited for use.....	417
17-2.Points to remember when installing	417

Part 1. INDOOR UNIT

COMPACT CASSETTE TYPE:

AUYG07LVLA
AUYG09LVLA

AUYG12LVLB
AUYG14LVLB

AUYG18LVLB

MINI DUCT TYPE:

ARYG07LSLAP
ARYG09LSLAP

ARYG12LSLAP
ARYG14LSLAP

ARYG18LSLAP

SLIM DUCT TYPE:

ARYG07LLTA
ARYG09LLTA

ARYG12LLTB
ARYG14LLTB

ARYG18LLTB

WALL MOUNTED TYPE:

ASYG07LUCA
ASYG09LUCA
ASYG12LUCA
ASYG14LUCA

ASYG07LMCA
ASYG09LMCA
ASYG12LMCA
ASYG14LMCA

ASYG07LMCE
ASYG09LMCE
ASYG12LMCE
ASYG14LMCE

ASYG18LFCA
ASYG24LFCA
ASYG24LFCC

FLOOR/CEILING TYPE:

ABYG14LVTA

ABYG18LVTB

FLOOR TYPE:

AGYG09LVCA

AGYG12LVCA

AGYG14LVCA

1. Model lineup

Indoor unit		
 AUYG07LVLA AUYG09LVLA AUYG12LVLB AUYG14LVLB AUYG18LVLB	 ARYG07LSLAP ARYG09LSLAP ARYG12LSLAP ARYG14LSLAP	 ARYG18LSLAP
 ARYG07LLTA ARYG09LLTA ARYG12LLTB ARYG14LLTB	 ARYG18LLTB	 ASYG07LMCA ASYG09LMCA ASYG12LMCA ASYG14LMCA
 ASYG07LMCE ASYG09LMCE ASYG12LMCE ASYG14LMCE	 ASYG07LUCA ASYG09LUCA ASYG12LUCA ASYG14LUCA	 ASYG18LFCA ASYG24LFCA ASYG24LFCC
 ABYG14LVTA ABYG18LVTB	 AGYG09LVCA AGYG12LVCA AGYG14LVCA	
Outdoor unit		
 AOYG36LBLA5 AOYG45LBLA6		

1-1. Connectable indoor units to each outdoor unit

●: Connectable / -: Not connectable

Outdoor unit	Compact cassette					Mini duct				
	AUYG07—09LVLA AUYG12—18LVLB					ARYG07—18LSLAP				
Btu class	07	09	12	14	18	07	09	12	14	18
kW class	2.0	2.5	3.5	4.0	5.0	2.0	2.5	3.5	4.0	5.0
AOYG36LBLA5	●	●	●	●	●	●	●	●	●	●
AOYG45LBLA6	●	●	●	●	●	●	●	●	●	●

Outdoor unit	Slim duct					Wall mounted			
	ARYG07—09LLTA ARYG12—18LLTB					LU/LM ASYG07—14LMCA ASYG07—14LMCE ASYG07—14LUCA			
Btu class	07	09	12	14	18	07	09	12	14
kW class	2.0	2.5	3.5	4.0	5.0	2.0	2.5	3.5	4.0
AOYG36LBLA5	●	●	●	●	●	●	●	●	●
AOYG45LBLA6	●	●	●	●	●	●	●	●	●

Outdoor unit	Wall mounted		Floor/Ceiling		Floor		
	LF ASYG18LFCA ASYG24LFCA ASYG24LFCC		ABYG14LVTA ABYG18LVTB		AGYG09—14LVCA		
Btu class	18	24	14	18	09	12	14
kW class	5.0	7.0	4.0	5.0	2.5	3.5	4.0
AOYG36LBLA5	●	●	●	●	●	●	●
AOYG45LBLA6	●	●	●	●	●	●	●

1-2. Indoor unit connection patterns

■ 5 rooms

AOYG36LBLA5						
No.	Room 1	Room 2	Room 3	Room 4	Room 5	Total
1	7	24	—	—	—	31
2	9	24	—	—	—	33
3	12	24	—	—	—	36
4	14	24	—	—	—	38
5	18	18	—	—	—	36
6	18	24	—	—	—	42
7	24	24	—	—	—	48
8	7	7	14	—	—	28
9	7	7	18	—	—	32
10	7	7	24	—	—	38
11	7	9	12	—	—	28
12	7	9	14	—	—	30
13	7	9	18	—	—	34
14	7	9	24	—	—	40
15	7	12	12	—	—	31
16	7	12	14	—	—	33
17	7	12	18	—	—	37
18	7	12	24	—	—	43
19	7	14	14	—	—	35
20	7	14	18	—	—	39
21	7	14	24	—	—	45
22	7	18	18	—	—	43
23	7	18	24	—	—	49
24	9	9	9	—	—	27
25	9	9	12	—	—	30
26	9	9	14	—	—	32
27	9	9	18	—	—	36
28	9	9	24	—	—	42
29	9	12	12	—	—	33
30	9	12	14	—	—	35
31	9	12	18	—	—	39
32	9	12	24	—	—	45
33	9	14	14	—	—	37
34	9	14	18	—	—	41
35	9	14	24	—	—	47
36	9	18	18	—	—	45
37	9	18	24	—	—	51
38	12	12	12	—	—	36
39	12	12	14	—	—	38
40	12	12	18	—	—	42
41	12	12	24	—	—	48
42	12	14	14	—	—	40
43	12	14	18	—	—	44
44	12	14	24	—	—	50
45	12	18	18	—	—	48
46	12	18	24	—	—	54
47	14	14	14	—	—	42
48	14	14	18	—	—	46
49	14	14	24	—	—	52
50	14	18	18	—	—	50
51	18	18	18	—	—	54
52	7	7	7	7	—	28
53	7	7	7	9	—	30
54	7	7	7	12	—	33
55	7	7	7	14	—	35
56	7	7	7	18	—	39
57	7	7	7	24	—	45
58	7	7	9	9	—	32
59	7	7	9	12	—	35
60	7	7	9	14	—	37
61	7	7	9	18	—	41
62	7	7	9	24	—	47
63	7	7	12	12	—	38
64	7	7	12	14	—	40
65	7	7	12	18	—	44
66	7	7	12	24	—	50
67	7	7	14	14	—	42
68	7	7	14	18	—	46
69	7	7	14	24	—	52
70	7	7	18	18	—	50
71	7	9	9	9	—	34
72	7	9	9	12	—	37
73	7	9	9	14	—	39
74	7	9	9	18	—	43
75	7	9	9	24	—	49
76	7	9	12	12	—	40
77	7	9	12	14	—	42
78	7	9	12	18	—	46
79	7	9	12	24	—	52
80	7	9	12	14	—	42
81	7	9	14	18	—	48
82	7	9	14	24	—	54
83	7	9	18	18	—	52
84	7	12	12	12	—	43

AOYG36LBLA5						
No.	Room 1	Room 2	Room 3	Room 4	Room 5	Total
85	7	12	12	14	—	45
86	7	12	12	18	—	49
87	7	12	14	14	—	47
88	7	12	14	18	—	51
89	7	14	14	14	—	49
90	7	14	14	18	—	53
91	9	9	9	9	—	36
92	9	9	9	12	—	39
93	9	9	9	14	—	41
94	9	9	9	18	—	45
95	9	9	9	24	—	51
96	9	9	12	12	—	42
97	9	9	12	14	—	44
98	9	9	12	18	—	48
99	9	9	12	24	—	54
100	9	9	14	14	—	46
101	9	9	14	18	—	50
102	9	9	18	18	—	54
103	9	12	12	12	—	45
104	9	12	12	14	—	47
105	9	12	12	18	—	51
106	9	12	14	14	—	49
107	9	12	14	18	—	53
108	9	14	14	14	—	51
109	12	12	12	12	—	48
110	12	12	12	14	—	50
111	12	12	12	18	—	54
112	12	12	14	14	—	52
113	12	14	14	14	—	54
114	7	7	7	7	7	35
115	7	7	7	7	9	37
116	7	7	7	7	12	40
117	7	7	7	7	14	42
118	7	7	7	7	18	46
119	7	7	7	7	24	52
120	7	7	7	9	9	39
121	7	7	7	9	12	42
122	7	7	7	9	14	44
123	7	7	7	9	18	48
124	7	7	7	9	24	54
125	7	7	7	12	12	45
126	7	7	7	12	14	47
127	7	7	7	12	18	51
128	7	7	7	14	14	49
129	7	7	7	14	18	53
130	7	7	9	9	9	41
131	7	7	9	9	12	44
132	7	7	9	9	14	46
133	7	7	9	9	18	50
134	7	7	9	12	12	47
135	7	7	9	12	14	49
136	7	7	9	12	18	53
137	7	7	9	14	14	51
138	7	7	12	12	12	50
139	7	7	12	12	14	52
140	7	7	12	14	14	54
141	7	9	9	9	9	43
142	7	9	9	9	12	46
143	7	9	9	9	14	48
144	7	9	9	9	18	52
145	7	9	9	12	12	49
146	7	9	9	12	14	51
147	7	9	9	14	14	53
148	7	9	12	12	12	52
149	7	9	12	12	14	54
150	9	9	9	9	9	45
151	9	9	9	9	12	48
152	9	9	9	9	14	50
153	9	9	9	9	18	54
154	9	9	9	12	12	51
155	9	9	9	12	14	53
156	9	9	12	12	12	54

NOTE: 7: 7,000Btu/h, 9: 9,000Btu/h, 12: 12,000Btu/h, 14: 14,000Btu/h, 18: 18,000Btu/h, 24: 24,000Btu/h

6 rooms

AOYG45LBLA6							
No.	Room 1	Room 2	Room 3	Room 4	Room 5	Room 6	Total
1	12	24	—	—	—	—	36
2	14	24	—	—	—	—	38
3	18	18	—	—	—	—	36
4	18	24	—	—	—	—	42
5	24	24	—	—	—	—	48
6	7	7	24	—	—	—	38
7	7	9	18	—	—	—	34
8	7	9	24	—	—	—	40
9	7	12	18	—	—	—	37
10	7	12	24	—	—	—	43
11	7	14	14	—	—	—	35
12	7	14	18	—	—	—	39
13	7	14	24	—	—	—	45
14	7	18	18	—	—	—	43
15	7	18	24	—	—	—	49
16	7	24	24	—	—	—	55
17	9	9	18	—	—	—	36
18	9	9	24	—	—	—	42
19	9	12	14	—	—	—	35
20	9	12	18	—	—	—	39
21	9	12	24	—	—	—	45
22	9	14	14	—	—	—	37
23	9	14	18	—	—	—	41
24	9	14	24	—	—	—	47
25	9	18	18	—	—	—	45
26	9	18	24	—	—	—	51
27	9	24	24	—	—	—	57
28	12	12	12	—	—	—	36
29	12	12	14	—	—	—	38
30	12	12	18	—	—	—	42
31	12	12	24	—	—	—	48
32	12	14	14	—	—	—	40
33	12	14	18	—	—	—	44
34	12	14	24	—	—	—	50
35	12	18	18	—	—	—	48
36	12	18	24	—	—	—	54
37	12	24	24	—	—	—	60
38	14	14	14	—	—	—	42
39	14	14	18	—	—	—	46
40	14	14	24	—	—	—	52
41	14	18	18	—	—	—	50
42	14	18	24	—	—	—	56
43	14	24	24	—	—	—	62
44	18	18	18	—	—	—	54
45	18	18	24	—	—	—	60
46	7	7	7	14	—	—	35
47	7	7	7	18	—	—	39
48	7	7	7	24	—	—	45
49	7	7	9	12	—	—	35
50	7	7	9	14	—	—	37
51	7	7	9	18	—	—	41
52	7	7	9	24	—	—	47
53	7	7	12	12	—	—	38
54	7	7	12	14	—	—	40
55	7	7	12	18	—	—	44
56	7	7	12	24	—	—	50
57	7	7	14	14	—	—	42
58	7	7	14	18	—	—	46
59	7	7	14	24	—	—	52
60	7	7	18	18	—	—	50
61	7	7	18	24	—	—	56
62	7	7	24	24	—	—	62
63	7	9	9	9	—	—	34
64	7	9	9	12	—	—	37
65	7	9	9	14	—	—	39
66	7	9	9	18	—	—	43
67	7	9	9	24	—	—	49
68	7	9	12	12	—	—	40
69	7	9	12	14	—	—	42
70	7	9	12	18	—	—	46
71	7	9	12	24	—	—	52
72	7	9	14	14	—	—	44
73	7	9	14	18	—	—	48
74	7	9	14	24	—	—	54
75	7	9	18	18	—	—	52
76	7	9	18	24	—	—	58
77	7	12	12	12	—	—	43
78	7	12	12	14	—	—	45
79	7	12	12	18	—	—	49
80	7	12	12	24	—	—	55
81	7	12	14	14	—	—	47
82	7	12	14	18	—	—	51
83	7	12	14	24	—	—	57
84	7	12	18	18	—	—	55
85	7	12	18	24	—	—	61
86	7	14	14	14	—	—	49
87	7	14	14	18	—	—	53
88	7	14	14	24	—	—	59

AOYG45LBLA6							
No.	Room 1	Room 2	Room 3	Room 4	Room 5	Room 6	Total
89	7	14	18	18	—	—	57
90	7	18	18	18	—	—	61
91	9	9	9	9	—	—	36
92	9	9	9	12	—	—	39
93	9	9	9	14	—	—	41
94	9	9	9	18	—	—	45
95	9	9	9	24	—	—	51
96	9	9	12	12	—	—	42
97	9	9	12	14	—	—	44
98	9	9	12	18	—	—	48
99	9	9	12	24	—	—	54
100	9	9	14	14	—	—	46
101	9	9	14	18	—	—	50
102	9	9	14	24	—	—	56
103	9	9	18	18	—	—	54
104	9	9	18	24	—	—	60
105	9	12	12	12	—	—	45
106	9	12	12	14	—	—	47
107	9	12	12	18	—	—	51
108	9	12	12	24	—	—	57
109	9	12	14	14	—	—	49
110	9	12	14	18	—	—	53
111	9	12	14	24	—	—	59
112	9	12	18	18	—	—	57
113	9	14	14	14	—	—	51
114	9	14	14	18	—	—	55
115	9	14	14	24	—	—	61
116	9	14	18	18	—	—	59
117	12	12	12	12	—	—	48
118	12	12	12	14	—	—	50
119	12	12	12	18	—	—	54
120	12	12	12	24	—	—	60
121	12	12	14	14	—	—	52
122	12	12	14	18	—	—	56
123	12	12	14	24	—	—	62
124	12	12	18	18	—	—	60
125	12	14	14	14	—	—	54
126	12	14	14	18	—	—	58
127	12	14	18	18	—	—	62
128	7	7	7	7	7	—	35
129	7	7	7	7	9	—	37
130	7	7	7	7	12	—	40
131	7	7	7	7	14	—	42
132	7	7	7	7	18	—	46
133	7	7	7	7	24	—	52
134	7	7	7	9	9	—	39
135	7	7	7	9	12	—	42
136	7	7	7	9	14	—	44
137	7	7	7	9	18	—	48
138	7	7	7	9	24	—	54
139	7	7	7	12	12	—	45
140	7	7	7	12	14	—	47
141	7	7	7	12	18	—	51
142	7	7	7	12	24	—	57
143	7	7	7	14	14	—	49
144	7	7	7	14	18	—	53
145	7	7	7	14	24	—	59
146	7	7	7	18	18	—	57
147	7	7	9	9	9	—	41
148	7	7	9	9	12	—	44
149	7	7	9	9	14	—	46
150	7	7	9	9	18	—	50
151	7	7	9	9	24	—	56
152	7	7	9	12	12	—	47
153	7	7	9	12	14	—	49
154	7	7	9	12	18	—	53
155	7	7	9	12	24	—	59
156	7	7	9	14	14	—	51
157	7	7	9	14	18	—	55
158	7	7	9	14	24	—	61
159	7	7	9	18	18	—	59
160	7	7	12	12	12	—	50
161	7	7	12	12	14	—	52
162	7	7	12	12	18	—	56
163	7	7	12	12	24	—	62
164	7	7	12	14	14	—	54
165	7	7	12	14	18	—	58
166	7	7	12	18	18	—	62
167	7	7	14	14	14	—	56
168	7	7	14	14	18	—	60
169	7	9	9	9	9	—	43
170	7	9	9	9	12	—	46
171	7	9	9	9	14	—	48
172	7	9	9	9	18	—	52
173	7	9	9	9	24	—	58
174	7	9	9	12	12	—	49
175	7	9	9	12	14	—	51
176	7	9	9	12	18	—	55
177	7	9	9	12	24	—	61
178	7	9	9	14	14	—	53
179	7	9	9	14	18	—	57

AOYG45LBLA6							
No.	Room 1	Room 2	Room 3	Room 4	Room 5	Room 6	Total
180	7	9	9	18	18	—	61
181	7	9	12	12	12	—	52
182	7	9	12	12	14	—	54
183	7	9	12	12	18	—	58
184	7	9	12	14	14	—	56
185	7	9	12	14	18	—	60
186	7	9	14	14	14	—	58
187	7	9	14	14	18	—	62
188	7	12	12	12	12	—	55
189	7	12	12	12	14	—	57
190	7	12	12	12	18	—	61
191	7	12	12	14	14	—	59
192	7	12	14	14	14	—	61
193	9	9	9	9	9	—	45
194	9	9	9	9	12	—	48
195	9	9	9	9	14	—	50
196	9	9	9	9	18	—	54
197	9	9	9	9	24	—	60
198	9	9	9	12	12	—	51
199	9	9	9	12	14	—	53
200	9	9	9	12	18	—	57
201	9	9	9	14	14	—	55
202	9	9	9	14	18	—	59
203	9	9	12	12	12	—	54
204	9	9	12	12	14	—	56
205	9	9	12	12	18	—	60
206	9	9	12	14	14	—	58
207	9	9	12	14	18	—	62
208	9	9	14	14	14	—	60
209	9	12	12	12	12	—	57
210	9	12	12	12	14	—	59
211	9	12	12	14	14	—	61
212	12	12	12	12	12	—	60
213	12	12	12	12	14	—	62
214	7	7	7	7	7	7	42
215	7	7	7	7	7	9	44
216	7	7	7	7	7	12	47
217	7	7	7	7	7	14	49
218	7	7	7	7	7	18	53
219	7	7	7	7	7	24	59
220	7	7	7	7	9	9	46
221	7	7	7	7	9	12	49
222	7	7	7	7	9	14	51
223	7	7	7	7	9	18	55
224	7	7	7	7	9	24	61
225	7	7	7	7	12	12	52
226	7	7	7	7	12	14	54
227	7	7	7	7	12	18	58
228	7	7	7	7	14	14	56
229	7	7	7	7	14	18	60
230	7	7	7	9	9	9	48
231	7	7	7	9	9	12	51
232	7	7	7	9	9	14	53
233	7	7	7	9	9	18	57
234	7	7	7	9	12	12	54
235	7	7	7	9	12	14	56
236	7	7	7	9	12	18	60
237	7	7	7	9	14	14	58
238	7	7	7	12	12	12	57
239	7	7	7	12	12	14	59
240	7	7	7	12	14	14	61
241	7	7	9	9	9	9	50
246	7	7	9	9	9	12	53
247	7	7	9	9	9	14	55
248	7	7	9	9	9	18	59
242	7	7	9	9	12	12	56
243	7	7	9	9	12	14	58
244	7	7	9	9	12	18	62
245	7	7	9	9	14	14	60
249	7	7	9	12	12	12	59
250	7	7	9	12	12	14	61
251	7	7	12	12	12	12	62
252	7	9	9	9	9	9	52
253	7	9	9	9	9	12	55
254	7	9	9	9	9	14	57
255	7	9	9	9	12	12	58
256	7	9	9	9	12	14	60
257	7	9	9	12	12	12	61
258	9	9	9	9	9	9	54
259	9	9	9	9	9	12	57
260	9	9	9	9	12	12	60

NOTE: 7: 7,000Btu/h, 9: 9,000Btu/h, 12: 12,000Btu/h, 14: 14,000Btu/h, 18: 18,000Btu/h, 24: 24,000Btu/h

2. Specifications

2-1. Compact cassette type

Model name				AUYG07LVLA	AUYG09LVLA	AUYG12LVLB
Power supply				1Ø 230 V ~50 Hz		
Available voltage range				198—264 V		
Capacity			kW class	2.0	2.5	3.5
Input power			W	18		23
Running current			A	0.15		0.19
Fan	Airflow rate	Cooling	HIGH	m ³ /h	540	610
			MED		490	530
			LOW		440	470
			QUIET		390	410
		Heating	HIGH		540	610
			MED		490	530
			LOW		440	470
			QUIET		390	410
	Type × Q'ty			Turbo fan × 1		
	Motor output			W	54	
Sound pressure level *	Cooling	HIGH	dB (A)	33	37	
		MED		31	33	
		LOW		29	31	
		QUIET		27	28	
	Heating	HIGH		34	37	
		MED		32	33	
		LOW		29	31	
		QUIET		27	28	
Sound power level	Cooling	dB (A)	46	49		
	Heating		47	49		
Heat exchanger type	Dimensions (H × W × D)		mm	210 × 1,310 × 13.3 + 210 × 1,250 × 13.3		
	Fin pitch		mm	1.2		
	Rows × Stages			2 × 10		
	Pipe type			Copper tube		
	Fin type			Aluminum		
Dimensions (H × W × D)	Net		mm	245 × 570 × 570		
	Gross			265 × 730 × 625		
Weight	Net		kg	15		
	Gross			18		
Connection pipe	Size	Liquid	mm (in)	Ø6.35 (Ø1/4)		
		Gas		Ø9.52 (Ø3/8)		
Method		Flare				
Operation range	Cooling	°C	18 to 32			
		%RH	80 or less			
Heating		°C	16 to 30			
Drain hose	Material	Hard PVC				
	Size	mm	Ø 25 (I.D.), Ø 32 (O.D.)			
Cassette grille	Model name		UTG-UFYD-W			
	Material		PS			
	Color		White (Approximate color of Munsell N 9.25/)			
	Dimensions (H × W × D)	Net	mm	49 × 700 × 700		
		Gross		120 × 765 × 755		
	Weight	Net	kg	2.6		
Gross		4.5				
Remote controller type				Wireless (Wired [option])		
NOTES:						
<ul style="list-style-type: none"> • The protective function might work when using it outside the operation range. • *: Sound pressure level: <ul style="list-style-type: none"> – These are the measured values in the manufacturer's anechoic chamber. – Because of the surrounding sound environment, the sound levels measured in actual installation conditions might be higher than the specified values here. 						

Model name				AUYG14LVLB	AUYG18LVLB	
Power supply				1Ø 230 V ~50 Hz		
Available voltage range				198—264 V		
Capacity			kW class	4.0	5.0	
Input power			W	28	39	
Running current			A	0.22	0.30	
Fan	Airflow rate	Cooling	HIGH	m ³ /h	680	750
			MED		580	610
			LOW		490	520
			QUIET		410	410
		Heating	HIGH		700	800
			MED		620	710
			LOW		550	600
			QUIET		430	450
	Type × Q'ty			Turbo fan × 1		
	Motor output			W	54	
Sound pressure level *	Cooling	HIGH	dB (A)	40	42	
		MED		35	37	
		LOW		32	33	
		QUIET		29	29	
	Heating	HIGH		40	44	
		MED		37	40	
		LOW		34	37	
		QUIET		29	30	
Sound power level		Cooling	dB (A)	52	54	
		Heating		52	56	
Heat exchanger type			Dimensions (H × W × D)	210 × 1,310 × 13.3 + 210 × 1,250 × 13.3		
			Fin pitch	1.2		
			Rows × Stages	2 × 10		
			Pipe type	Copper tube		
			Fin type	Aluminum		
Dimensions (H × W × D)	Net		mm	245 × 570 × 570		
	Gross			265 × 730 × 625		
Weight	Net		kg	15		
	Gross			18		
Connection pipe	Size	Liquid	mm (in)	Ø6.35 (Ø1/4)		
		Gas		Ø12.70 (Ø1/2)		
	Method			Flare		
Operation range		Cooling	°C	18 to 32		
				%RH	80 or less	
		Heating	°C	16 to 30		
Drain hose	Material		Hard PVC			
	Size		mm	Ø 25 (I.D.), Ø 32 (O.D.)		
Cassette grille	Model name			UTG-UFYD-W		
	Material			PS		
	Color			White (Approximate color of Munsell N 9.25/)		
	Dimensions (H × W × D)	Net	mm	49 × 700 × 700		
		Gross		120 × 765 × 755		
	Weight	Net	kg	2.6		
Gross		4.5				
Remote controller type				Wireless (Wired [option])		
NOTES:						
<ul style="list-style-type: none"> • The protective function might work when using it outside the operation range. • *: Sound pressure level: <ul style="list-style-type: none"> – These are the measured values in the manufacturer's anechoic chamber. – Because of the surrounding sound environment, the sound levels measured in actual installation conditions might be higher than the specified values here. 						

2-2. Mini duct type

Model name				ARYG07LSLAP	ARYG09LSLAP	ARYG12LSLAP	
Power supply				1Ø 230 V ~50 Hz			
Available voltage range				198—264 V			
Capacity				kW class			
				2.0	2.5	3.5	
Input power	Fan		HIGH	33	40	47	
			MED	23	23	26	
			LOW	20	20	22	
			QUIET	18	18	18	
Running current				A	0.29	0.33	0.38
Fan	Airflow rate	Cooling	HIGH	m ³ /h	550	600	650
			MED		440	450	490
			LOW		390	400	430
			QUIET		360	360	360
		Heating	HIGH		550	600	650
			MED		440	450	490
			LOW		390	400	430
			QUIET		360	360	360
	Type × Q'ty				Sirocco fan × 2		
	Motor output				W	75	
Recommended static pressure				Pa	0 to 30		
Sound pressure level *	Cooling	HIGH	dB (A)	29	29	31	
		MED		26	26	27	
		LOW		24	24	25	
		QUIET		23	23	23	
	Heating	HIGH		29	29	31	
		MED		26	26	27	
		LOW		24	24	25	
		QUIET		23	23	23	
Sound power level		Cooling	dB (A)	52	54	55	
		Heating		53	56	57	
Heat exchanger type	Dimensions (H × W × D)		mm	336 × 490 × 26.6			
	Fin pitch		mm	1.3			
	Rows × Stages			2 × 16			
	Pipe type			Copper tube			
	Fin type			Aluminum			
Enclosure	Material			Steel sheet			
	Color			—			
Dimensions (H × W × D)	Net		mm	198 × 700 × 450			
	Gross			250 × 930 × 580			
Weight	Net		kg	15.5			
	Gross			19.5			
Connection pipe	Size	Liquid	mm (in)	Ø6.35 (Ø1/4)			
		Gas		Ø9.52 (Ø3/8)			
	Method				Flare		
Operation range	Cooling		°C	18 to 32			
			%RH	80 or less			
	Heating		°C	16 to 30			
Drain hose	Material			Hard PVC			
	Size		mm	Ø 25 (I.D.), Ø 32 (O.D.)			
Remote controller type					Wired (Wireless [option])		

NOTES:

- Values mentioned in the table are based on the following conditions:
 - Static pressure: 10 Pa
- The protective function might work when using it outside the operation range.
- *: Sound pressure level:
 - These are the measured values in the manufacturer's anechoic chamber.
 - Because of the surrounding sound environment, the sound levels measured in actual installation conditions might be higher than the specified values here.

Model name				ARYG14LSLAP	ARYG18LSLAP		
Power supply				1Ø 230 V ~50 Hz			
Available voltage range				198—264 V			
Capacity			kW class	4.0	5.0		
Input power	Fan	HIGH	W	72	63		
		MED		44	38		
		LOW		30	22		
		QUIET		18	19		
Running current			A	0.58	0.49		
Fan	Airflow rate	Cooling	m ³ /h	HIGH	800	940	
				MED	640	750	
				LOW	530	540	
				QUIET	360	480	
	Heating	HIGH		800	940		
		MED		640	750		
		LOW		530	540		
		QUIET		360	480		
		Type × Q'ty			Sirocco fan × 2	Sirocco fan × 3	
		Motor output		W	75	80	
Recommended static pressure			Pa	0 to 50			
Sound pressure level *	Cooling	HIGH	dB (A)	35	33		
		MED		30	29		
		LOW		27	26		
		QUIET		23	23		
	Heating	HIGH		35	33		
		MED		30	29		
		LOW		27	26		
		QUIET		23	23		
Sound power level			dB (A)	60	58		
				62	59		
Heat exchanger type			Dimensions (H × W × D)	mm	336 × 490 × 26.6	336 × 690 × 26.6	
			Fin pitch	mm	1.3		
			Rows × Stages	2 × 16			
			Pipe type	Copper tube			
			Fin type	Aluminum			
Enclosure	Material		Steel sheet				
	Color		—				
Dimensions (H × W × D)	Net		mm	198 × 700 × 450	198 × 900 × 450		
	Gross			250 × 930 × 580	250 × 1,130 × 580		
Weight	Net		kg	15.5	18.5		
	Gross			19.5	23.0		
Connection pipe	Size	Liquid	mm (in)	Ø6.35 (Ø1/4)			
		Gas		Ø12.7 (Ø1/2)			
	Method			Flare			
Operation range		Cooling	°C	18 to 32			
			%RH	80 or less			
		Heating	°C	16 to 30			
Drain hose	Material		Hard PVC				
	Size		mm	Ø 25 (I.D.), Ø 32 (O.D.)			
Remote controller type				Wired (Wireless [option])			

NOTES:

- Values mentioned in the table are based on the following conditions:
 - Static pressure: 15 Pa
- The protective function might work when using it outside the operation range.
- *: Sound pressure level:
 - These are the measured values in the manufacturer's anechoic chamber.
 - Because of the surrounding sound environment, the sound levels measured in actual installation conditions might be higher than the specified values here.

2-3. Slim duct type

Model name				ARYG07LLTA	ARYG09LLTA	ARYG12LLTB	
Power supply				1Ø 230 V ~50 Hz			
Available voltage range				198—264 V			
Capacity		kW class		2.0	2.5	3.5	
Input power		W		33	49	58	
Running current		A		0.33	0.30	0.35	
Fan	Airflow rate	Cooling	HIGH	m ³ /h	550	600	650
			MED		490	550	600
			LOW		470	500	550
			QUIET		440	450	480
		Heating	HIGH		550	600	650
			MED		490	550	600
			LOW		470	500	550
			QUIET		440	450	480
	Type × Q'ty		Sirocco fan × 2				
	Motor output		W		80	81	
Recommended static pressure				Pa			
				0 to 90			
Sound pressure level *	Cooling	HIGH	dB (A)	28	28	29	
		MED		26	27	28	
		LOW		25	26	27	
		QUIET		24	25	26	
	Heating	HIGH		28	28	29	
		MED		26	26	28	
		LOW		25	25	27	
		QUIET		24	24	24	
Sound power level		Cooling		dB (A)		57	58
		Heating				57	58
Heat exchanger type		Dimensions (H × W × D)		mm		294 × 500 × 26.6	294 × 500 × 39.9
		Fin pitch		mm		1.3	
		Rows × Stages				2 × 14	3 × 14
		Pipe type				Copper tube	
		Fin type				Aluminum	
Enclosure		Material		Steel sheet			
		Color		—			
Dimensions (H × W × D)		Net		mm			
		Gross		198 × 700 × 620			
Weight		Net		kg			
		Gross		17			
Connection pipe		Liquid		mm (in)			
		Gas		Ø6.35 (Ø1/4)			
		Method		Ø9.52 (Ø3/8)			
Operation range		Cooling		°C			
		Heating		%RH			
				°C			
Drain hose		Material		Hard PVC			
		Size		mm			
Remote controller type		Wired (Wireless [option])					
NOTES:							
<ul style="list-style-type: none"> • Values mentioned in the table are based on the following conditions: <ul style="list-style-type: none"> – Static pressure: 25 Pa • The protective function might work when using it outside the operation range. • *: Sound pressure level: <ul style="list-style-type: none"> – These are the measured values in the manufacturer's anechoic chamber. – Because of the surrounding sound environment, the sound levels measured in actual installation conditions might be higher than the specified values here. 							

Model name				ARYG14LLTB	ARYG18LLTB	
Power supply				1Ø 230 V ~50 Hz		
Available voltage range				198—264 V		
Capacity			kW class	4.0	5.0	
Input power			W	76	73	
Running current			A	0.51	0.44	
Fan	Airflow rate	Cooling	HIGH	800	940	
			MED	700	880	
			LOW	600	820	
			QUIET	480	750	
		Heating	HIGH	800	940	
			MED	700	880	
			LOW	600	820	
			QUIET	480	750	
	Type × Q'ty		Sirocco fan × 2		Sirocco fan × 3	
	Motor output		W	81		
Recommended static pressure			Pa	0 to 90		
Sound pressure level *	Cooling	HIGH	dB (A)	32	32	
		MED		30	31	
		LOW		28	30	
		QUIET		26	29	
	Heating	HIGH		33	33	
		MED		30	32	
		LOW		28	31	
		QUIET		25	29	
Sound power level		Cooling	dB (A)	60	58	
		Heating		61	59	
Heat exchanger type	Dimensions (H × W × D)		mm	294 × 500 × 39.9	294 × 700 × 39.9	
	Fin pitch		mm	1.3		
	Rows × Stages		3 × 14			
	Pipe type		Copper tube			
	Fin type		Aluminum			
Enclosure	Material			Steel sheet		
	Color			—		
Dimensions (H × W × D)	Net		mm	198 × 700 × 620	198 × 900 × 620	
	Gross			274 × 945 × 772	274 × 1,145 × 772	
Weight	Net		kg	19	23	
	Gross			23	27	
Connection pipe	Size	Liquid	mm (in)	Ø6.35 (Ø1/4)		
		Gas		Ø12.70 (Ø1/2)		
	Method			Flare		
Operation range	Cooling	°C		18 to 32		
		%RH		80 or less		
	Heating	°C		16 to 30		
Drain hose	Material			Hard PVC		
	Size		mm	Ø 25 (I.D.), Ø 32 (O.D.)		
Remote controller type				Wired (Wireless [option])		

NOTES:

- Values mentioned in the table are based on the following conditions:
 - Static pressure: 25 Pa
- The protective function might work when using it outside the operation range.
- *: Sound pressure level:
 - These are the measured values in the manufacturer's anechoic chamber.
 - Because of the surrounding sound environment, the sound levels measured in actual installation conditions might be higher than the specified values here.

2-4. Wall mounted type

Model name				ASYG07LUCA	ASYG09LUCA	ASYG12LUCA	ASYG14LUCA	
Power supply				1Ø 230 V ~50 Hz				
Available voltage range				198—264 V				
Capacity		kW class		2.0	2.5	3.5	4.0	
Input power		W		13	16	19	23	
Running current		A		0.13	0.14	0.17	0.20	
Fan	Airflow rate	Cooling	HIGH	m ³ /h	570	600	660	710
			MED		520	550	600	640
			LOW		470	470	530	570
			QUIET		330	330	330	390
		Heating	HIGH		570	600	660	710
			MED		520	550	600	640
			LOW		470	470	530	590
			QUIET		330	330	330	430
	Type × Q'ty		Cross flow fan × 1					
	Motor output		W		36			
Sound pressure level *	Cooling	HIGH	dB (A)	35	36	37	41	
		MED		30	32	34	36	
		LOW		28	28	31	33	
		QUIET		21	21	21	25	
	Heating	HIGH		35	36	37	41	
		MED		30	32	34	36	
		LOW		28	28	31	34	
		QUIET		21	21	21	27	
Sound power level	Cooling	dB (A)	53	54	55	59		
	Heating		53	54	55	59		
Heat exchanger type	Dimensions (H × W × D)		mm	Main: 320 × 690 × 20 Sub: 84 × 690 × 13.3				
	Fin pitch		mm	Main: 1.1, Sub: 1.4				
	Rows × Stages			Main: 2 × 20, Sub: 1 × 4				
	Pipe type			Copper tube				
	Fin type			Aluminum				
Enclosure	Material			Polystyrene				
	Color			White Approximate color of Munsell N 9.3				
Dimensions (H × W × D)	Net		mm	282 × 870 × 185				
	Gross			247 × 920 × 373				
Weight	Net		kg	9.5				
	Gross			12				
Connection pipe	Size	Liquid	mm (in)	Ø6.35 (Ø1/4)				
		Gas		Ø9.52 (Ø3/8)		Ø12.7 (Ø1/2)		
Drain hose	Method			Flare				
	Material			PP + LLDPE				
Operation range	Size		mm	Ø13.8 (I.D.), Ø15.8 to Ø16.7 (O.D.)				
	Cooling	°C		18 to 32				
Heating		%RH		80 or less				
	°C		16 to 30					
Remote controller type				Wireless (Wired [option])				
NOTES:								
<ul style="list-style-type: none"> • The protective function might work when using it outside the operation range. • *: Sound pressure level: <ul style="list-style-type: none"> – These are the measured values in the manufacturer's anechoic chamber. – Because of the surrounding sound environment, the sound levels measured in actual installation conditions might be higher than the specified values here. 								

Model name				ASYG07LMCA	ASYG09LMCA	ASYG12LMCA	ASYG14LMCA	
Power supply				1Ø 230 V ~50 Hz				
Available voltage range				198—264 V				
Capacity			kW class	2.0	2.5	3.5	4.0	
Input power				W	15	17	22	
Running current				A	0.13	0.15	0.19	
Fan	Airflow rate	Cooling	HIGH	m ³ /h	560	600	660	730
			MED		500	520	560	600
			LOW		430	430	450	530
			QUIET		310	310	310	360
		Heating	HIGH		560	600	660	730
			MED		500	520	560	615
			LOW		430	430	470	560
			QUIET		330	330	330	375
	Type × Q'ty		Cross flow fan × 1					
	Motor output			W	35			
Sound pressure level *	Cooling	HIGH	dB (A)	36	37	40	42	
		MED		32	33	36	38	
		LOW		29	29	30	33	
		QUIET		21	21	21	25	
	Heating	HIGH		36	37	40	42	
		MED		32	33	36	38	
		LOW		29	29	31	35	
		QUIET		22	22	22	27	
Sound power level	Cooling	dB (A)	51	52	54	56		
	Heating		51	52	55	57		
Heat exchanger type	Dimensions (H × W × D)		mm	Main: 320 × 630 × 20 Sub: 84 × 630 × 13.3				
	Fin pitch		mm	Main: 1.1, Sub: 1.4				
	Rows × Stages			Main: 2 × 20, Sub: 1 × 4				
	Pipe type			Copper tube				
	Fin type			Aluminum				
Enclosure	Material			Polystyrene				
	Color			White Approximate color of Munsell N 9.25/				
Dimensions (H × W × D)	Net		mm	268 × 840 × 203				
	Gross			270 × 884 × 336				
Weight	Net		kg	8.5				
	Gross			10.5				
Connection pipe	Size	Liquid	mm (in)	Ø6.35 (Ø1/4)				
		Gas		Ø9.52 (Ø3/8)		Ø12.7 (Ø1/2)		
	Method			Flare				
Drain hose	Material			PP + LLDPE				
	Size		mm	Ø13.8 (I.D.), Ø15.8 to Ø16.7 (O.D.)				
Operation range	Cooling	°C		18 to 32				
		%RH		80 or less				
Remote controller type	Heating	°C		16 to 30				
		Wireless (Wired [option])						
NOTES:								
<ul style="list-style-type: none"> • The protective function might work when using it outside the operation range. • *: Sound pressure level: <ul style="list-style-type: none"> – These are the measured values in the manufacturer's anechoic chamber. – Because of the surrounding sound environment, the sound levels measured in actual installation conditions might be higher than the specified values here. 								

Model name				ASYG07LMCE	ASYG09LMCE	ASYG12LMCE	ASYG14LMCE	
Power supply				1Ø 230 V ~50 Hz				
Available voltage range				198—264 V				
Capacity			kW class	2.0	2.5	3.5	4.0	
Input power				W	15	17	22	
Running current				A	0.13	0.15	0.19	
Fan	Airflow rate	Cooling	HIGH	m ³ /h	560	600	660	730
			MED		500	520	560	600
			LOW		430	430	450	530
			QUIET		310	310	310	360
		Heating	HIGH		560	600	660	730
			MED		500	520	560	615
			LOW		430	430	470	560
			QUIET		330	330	330	375
	Type × Q'ty		Cross flow fan × 1					
	Motor output			W	35			
Sound pressure level *	Cooling	HIGH	dB (A)	36	37	40	42	
		MED		32	33	36	38	
		LOW		29	29	30	33	
		QUIET		21	21	21	25	
	Heating	HIGH		36	37	40	42	
		MED		32	33	36	38	
		LOW		29	29	31	35	
		QUIET		22	22	22	27	
Sound power level	Cooling	dB (A)	51	52	54	56		
	Heating		51	52	55	57		
Heat exchanger type	Dimensions (H × W × D)		mm	Main: 320 × 630 × 20 Sub: 84 × 630 × 13.3				
	Fin pitch		mm	Main: 1.1, Sub: 1.4				
	Rows × Stages			Main: 2 × 20, Sub: 1 × 4				
	Pipe type			Copper tube				
	Fin type			Aluminum				
Enclosure	Material			Polystyrene				
	Color			White Approximate color of Munsell N 9.25/				
Dimensions (H × W × D)	Net		mm	270 × 870 × 204				
	Gross			270 × 925 × 336				
Weight	Net		kg	8.5				
	Gross			11.0				
Connection pipe	Size	Liquid	mm (in)	Ø6.35 (Ø1/4)				
		Gas		Ø9.52 (Ø3/8)		Ø12.7 (Ø1/2)		
	Method			Flare				
Drain hose	Material			PP + LLDPE				
	Size		mm	Ø13.8 (I.D.), Ø15.8 to Ø16.7 (O.D.)				
Operation range	Cooling	°C		18 to 32				
		%RH		80 or less				
Remote controller type	Heating	°C		16 to 30				
		Wireless (Wired [option])						
NOTES:								
<ul style="list-style-type: none"> • The protective function might work when using it outside the operation range. • *: Sound pressure level: <ul style="list-style-type: none"> – These are the measured values in the manufacturer's anechoic chamber. – Because of the surrounding sound environment, the sound levels measured in actual installation conditions might be higher than the specified values here. 								

Model name				ASYG18LFCA	ASYG24LFCA	ASYG24LFCC	
Power supply				1Ø 230 V ~50 Hz			
Available voltage range				198—264 V			
Capacity			kW class	5.0	7.0		
Input power			W	37	69		
Running current			A	0.33	0.53		
Fan	Airflow rate	Cooling	HIGH	m ³ /h	900	1,120	
			MED		740	900	
			LOW		620	740	
			QUIET		550	620	
		Heating	HIGH		900	1,100	
			MED		740	900	
			LOW		620	740	
			QUIET		550	620	
	Type × Q'ty		Cross flow fan × 1				
	Motor output			W	42	65	
Sound pressure level *	Cooling	HIGH	dB (A)	43	49		
		MED		37	42		
		LOW		33	37		
		QUIET		26	33		
	Heating	HIGH		42	48		
		MED		37	42		
		LOW		33	37		
		QUIET		25	33		
Sound power level	Cooling	dB (A)	58	64			
	Heating		58	64			
Heat exchanger type	Dimensions (H × W × D)		mm	Main: 378 × 832 × 26.6 Sub: 84 × 832 × 13.3			
	Fin pitch		mm	Main: 1.2, Sub: 1.4			
	Rows × Stages			Main: 2 × 18, Sub: 1 × 4	Main: 2 × 18, Sub: 1 × 4 + 1 × 4		
	Pipe type			Copper tube			
	Fin type			Aluminum			
Enclosure	Material			Polystyrene			
	Color			White Approximate color of Munsell N 9.25/			
Dimensions (H × W × D)	Net		mm	320 × 998 × 238			
	Gross			329 × 1,090 × 420			
Weight	Net		kg	14			
	Gross			18			
Connection pipe	Size	Liquid	mm (in)	Ø6.35 (Ø1/4)			
		Gas		Ø12.70 (Ø1/2)	Ø15.88 (Ø5/8)		
	Method			Flare			
Drain hose	Material			PVC			
	Size		mm	Ø12 (I.D.), Ø16 (O.D.)			
Operation range	Cooling	°C		18 to 32			
		%RH		80 or less			
Remote controller type	Heating	°C		16 to 32			
		Wireless (Wired [option])					
NOTES:							
<ul style="list-style-type: none"> The protective function might work when using it outside the operation range. *: Sound pressure level: <ul style="list-style-type: none"> These are the measured values in the manufacturer's anechoic chamber. Because of the surrounding sound environment, the sound levels measured in actual installation conditions might be higher than the specified values here. 							

2-5. Floor/Ceiling type

Model name				ABYG14LVTA	ABYG18LVTB	
Power supply				1Ø 230 V ~50 Hz		
Available voltage range				198—264 V		
Capacity			kWh class	4.0	5.0	
Input power			W	26	47	
Running current			A	0.21	0.36	
Fan	Airflow rate	Cooling	HIGH	m ³ /h	640	780
			MED		590	700
			LOW		540	560
			QUIET		480	500
		Heating	HIGH		640	780
			MED		590	700
			LOW		540	560
			QUIET		480	500
	Type × Q'ty			Sirocco fan × 2		
	Motor output			W	80	
Sound pressure level *	Cooling	HIGH	dB (A)	36 (Under ceiling)	41 (Under ceiling)	
				39 (Floor console)	44 (Floor console)	
				34 (Under ceiling)	38 (Under ceiling)	
				37 (Floor console)	41 (Floor console)	
	Cooling	MED		33 (Under ceiling)	34 (Under ceiling)	
				36 (Floor console)	37 (Floor console)	
				29 (Under ceiling)	32 (Under ceiling)	
				32 (Floor console)	35 (Floor console)	
	Heating	HIGH		36 (Under ceiling)	41 (Under ceiling)	
				39 (Floor console)	44 (Floor console)	
				34 (Under ceiling)	38 (Under ceiling)	
				37 (Floor console)	41 (Floor console)	
Heating	MED	33 (Under ceiling)	34 (Under ceiling)			
		36 (Floor console)	37 (Floor console)			
		29 (Under ceiling)	32 (Under ceiling)			
		32 (Floor console)	35 (Floor console)			
Sound power level	Cooling	dB (A)	51	55		
	Heating		51	55		
Heat exchanger type	Dimensions (H × W × D)		mm	252 × 800 × 26.6	252 × 800 × 39.9	
	Fin pitch		mm	1.2	1.3	
	Rows × Stages			2 × 12	3 × 12	
	Pipe type			Copper tube		
	Fin type			Aluminum		
Enclosure	Material			ABS		
	Color			White (Approximate color of Munsell N 9.25/)		
Dimensions (H × W × D)	Net		mm	199 × 990 × 655		
	Gross			320 × 1,150 × 790		
Weight	Net		kg	27		
	Gross			36		
Connection pipe	Size	Liquid	mm (in)	Ø6.35 (Ø1/4)		
		Gas		Ø12.70 (Ø1/2)		
	Method			Flare		
Drain hose	Material			Hard PVC		
	Size			Ø25 (I.D.), Ø32 (O.D.)		
Operation range	Cooling	°C		18 to 32		
		%RH		80 or less		
Remote controller type	Heating	°C		16 to 30		
		Wireless (Wired [option])				
NOTES:						
<ul style="list-style-type: none"> The protective function might work when using it outside the operation range. *Sound pressure level: <ul style="list-style-type: none"> Measured values in manufacturer's anechoic chamber. Because of the surrounding sound environment, the sound levels measured in actual installation conditions might be higher than the specified values here. 						

2-6. Floor type

Model name				AGYG09LVCA	AGYG12LVCA	AGYG14LVCA	
Power supply				1Ø 230 V ~50 Hz			
Available voltage range				198—264 V			
Capacity		kW class		2.5	3.5	4.0	
Input power		W		16	20	23	
Running current		A		0.15	0.18	0.20	
Fan	Airflow rate	Cooling	HIGH	m ³ /h	530	600	650
			MED		440	490	520
			LOW		360	380	400
			QUIET		270	270	270
		Heating	HIGH		530	600	650
			MED		460	510	540
			LOW		380	410	430
			QUIET		270	270	270
	Type × Q'ty		Cross flow fan × 2				
	Motor output		W		16		
Sound pressure level *	Cooling	dB (A)	HIGH	39	42	44	
			MED	34	36	38	
			LOW	28	30	31	
			QUIET	22	22	22	
	Heating	dB (A)	HIGH	39	42	44	
			MED	35	38	39	
			LOW	30	32	33	
			QUIET	22	22	22	
Sound power level	Cooling	dB (A)	52	55	56		
	Heating		52	55	56		
Heat exchanger type	Dimensions (H × W × D)		mm	378 × 550 × 26.6			
	Fin pitch		mm	1.2			
	Rows × Stages			2 × 18			
	Pipe type			Copper tube			
	Fin type			Aluminum			
Enclosure	Material			Polystyrene			
	Color			White (Approximate color of Munsell N 9.25/)			
Dimensions (H × W × D)	Net		mm	600 × 740 × 200			
	Gross			700 × 820 × 310			
Weight	Net		kg	14			
	Gross			17			
Connection pipe	Size	Liquid	mm (in)	Ø6.35 (Ø1/4)			
		Gas		Ø9.52 (Ø3/8)	Ø12.70 (Ø1/2)		
	Method				Flare		
Drain hose	Material			PVC			
	Size		mm	Ø13.8 (I.D.), Ø16.7 (O.D.)			
Operation range	Cooling	°C		18 to 32			
		%RH		80 or less			
	Heating	°C		16 to 30			
Remote controller type				Wireless (Wired [option])			
NOTES:							
<ul style="list-style-type: none"> The protective function might work when using it outside the operation range. *Sound pressure level: <ul style="list-style-type: none"> Measured values in manufacturer's anechoic chamber. Because of the surrounding sound environment, the sound levels measured in actual installation conditions might be higher than the specified values here. 							

3. Dimensions

3-1. Compact cassette type

■ Models: AUYG07LVLA, AUYG09LVLA, AUYG12LVLB, AUYG14LVLB, and AUYG18LVLB

Unit: mm

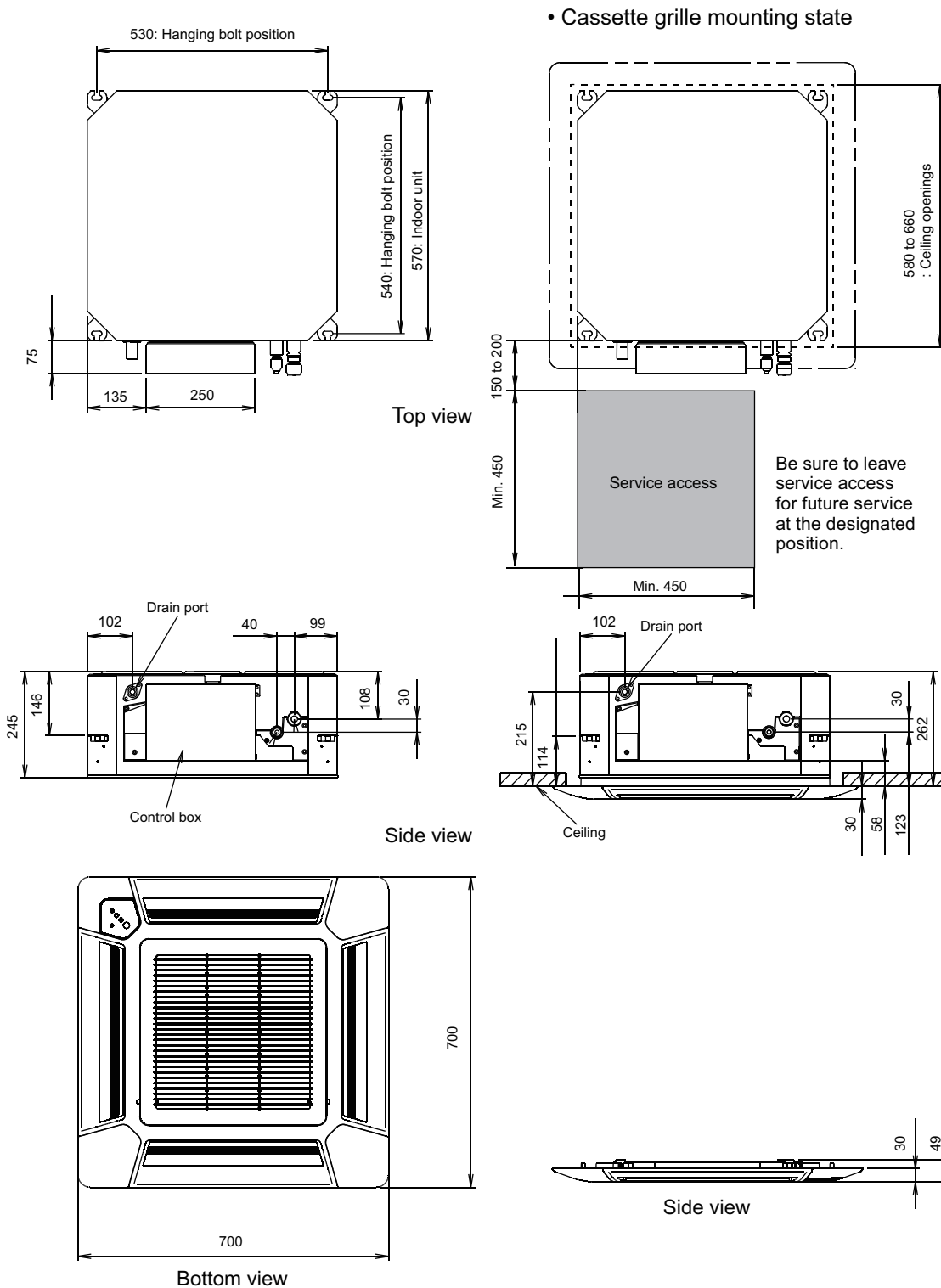

● Installation space

Unit: mm

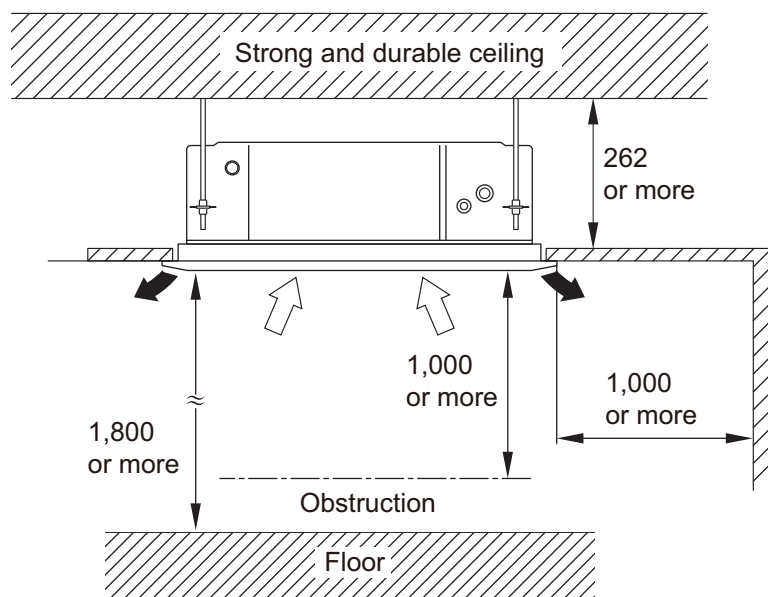

	Maximum height from floor to ceiling (Unit: mm)				
Model name	AUYG07LVLA	AUYG09LVLA	AUYG12LVLB	AUYG14LVLB	AUYG18LVLB
Standard mode	2,700				
High ceiling mode	—		3,000		

• 3-way direction setting

Unit: mm

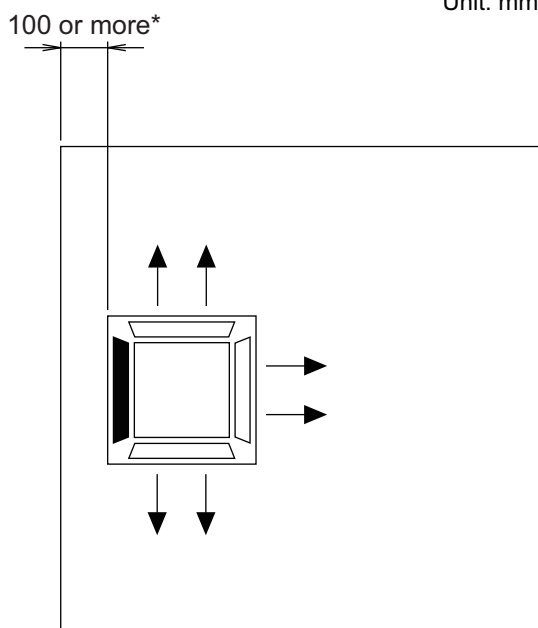

NOTES:

- *: When installing the indoor unit, be careful about the maintenance space.
- To set "3-direction", optional Air outlet shutter plate (UTR-YDZB) must be installed, and the "outlet-direction" need to be switched to "3-way" by remote controller.
- The ceiling height cannot be set in the 3-way outlet mode. Therefore, ceiling height setting change by function setting 20 is prohibited. For details, refer to ["Contents of function setting"](#) on page 241.

3-2. Mini duct type

■ Models: ARYG07LSLAP, ARYG09LSLAP, ARYG12LSLAP, and ARYG14LSLAP

Unit: mm

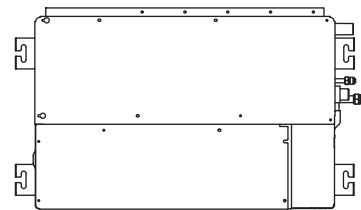
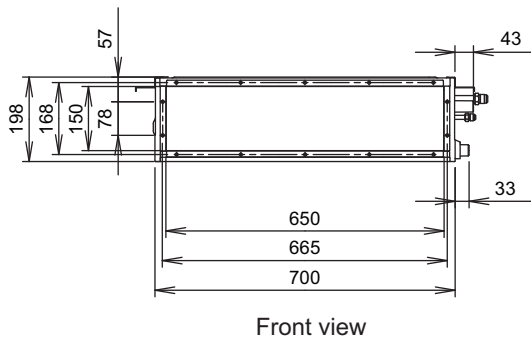
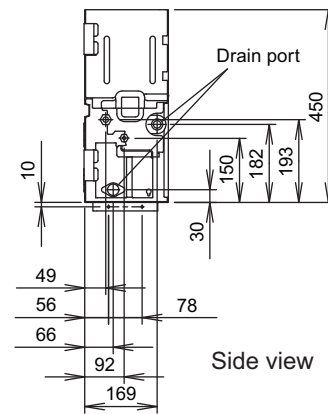
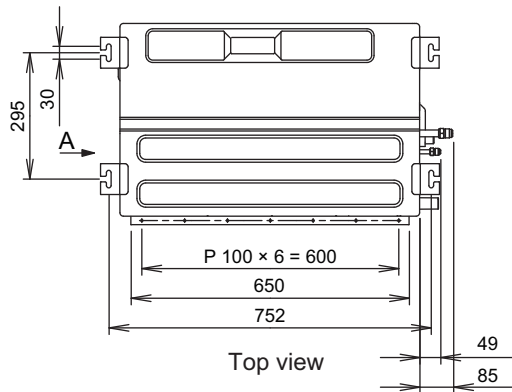
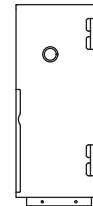
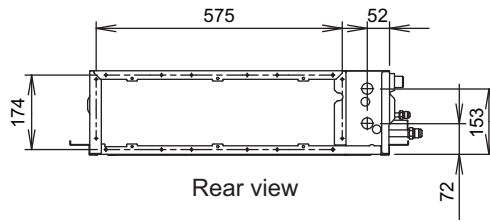

Model: ARYG18LSLAP

Unit: mm

MULTI TYPE
5, 6 ROOMS TYPE

MULTI TYPE
5, 6 ROOMS TYPE

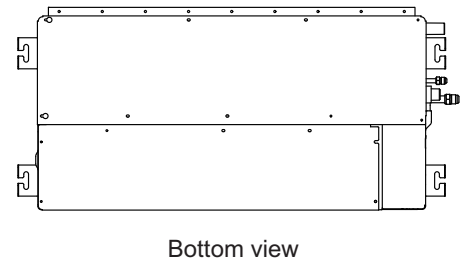
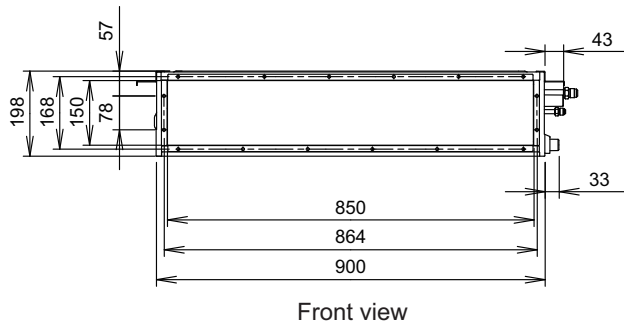
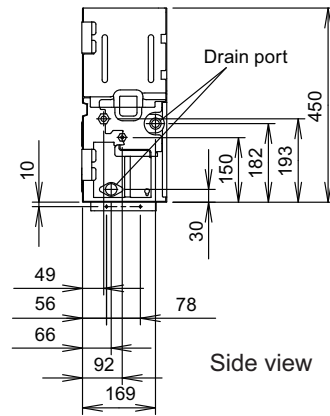
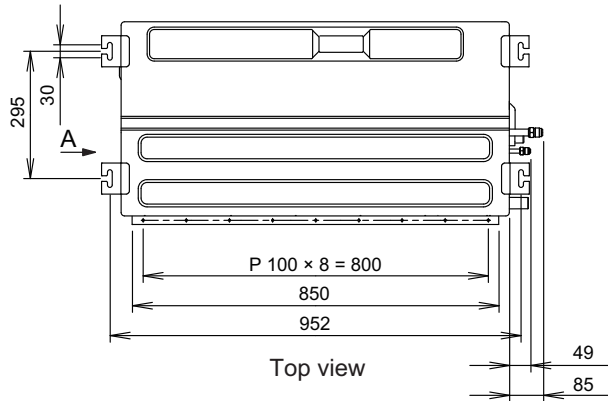
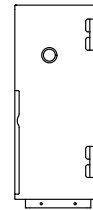
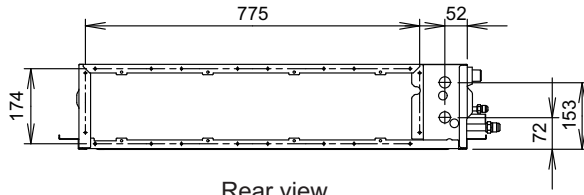

■ Installation space requirement

Provide sufficient installation space for product safety.

Unit: mm

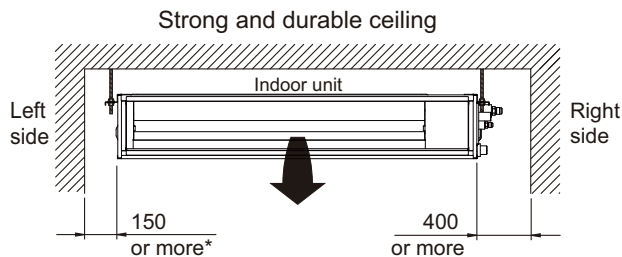

*: 400 or more when drain from drain pipe

- When intaking air from back:

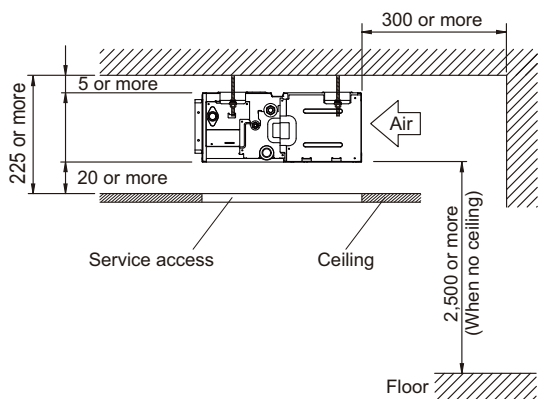

- When intaking air from bottom:

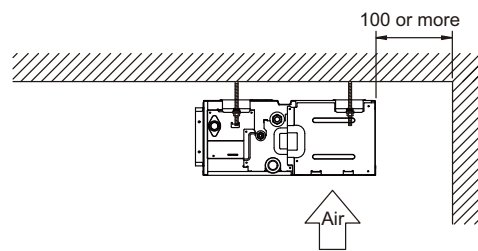

■ Maintenance space requirement

For future maintenance and service access, provide sufficient maintenance space.

NOTE: Do not place any wiring or illumination in the maintenance space, as they will impede service.

Unit: mm

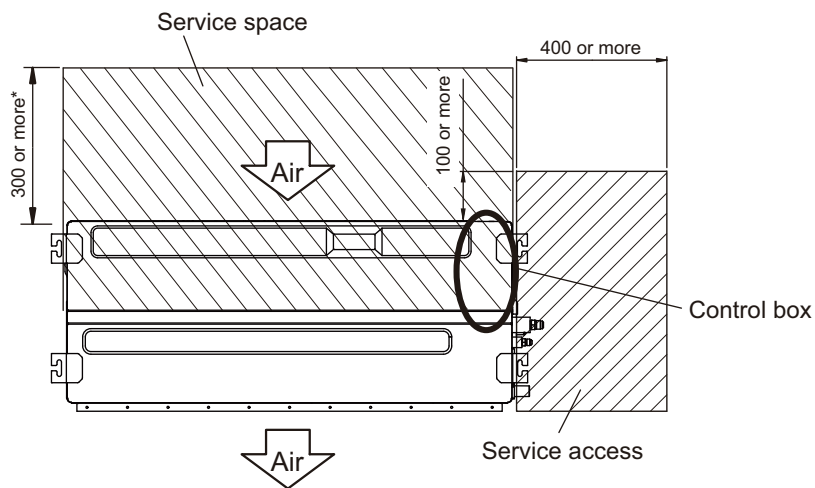

*: More than 100 when intaking air from bottom

Top view

3-3. Slim duct type

■ Models: ARYG07LLTA, ARYG09LLTA, ARYG12LLTB, and ARYG14LLTB

Unit: mm

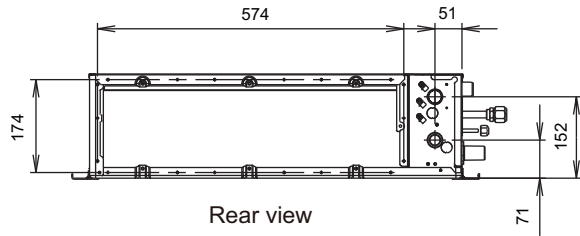

Rear view

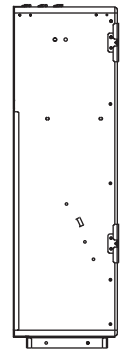

View A

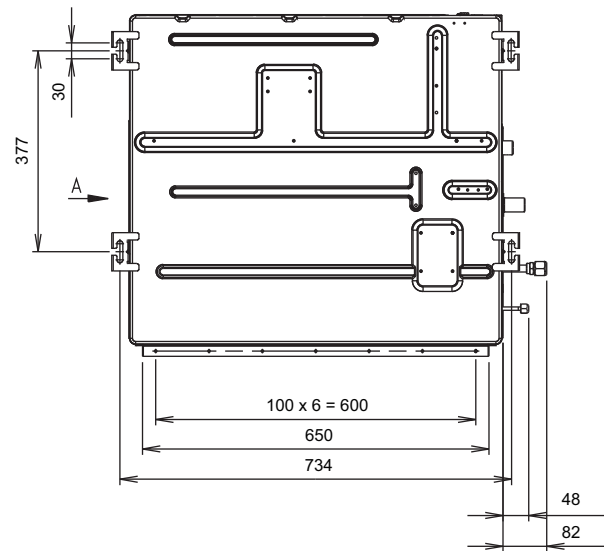

Top view

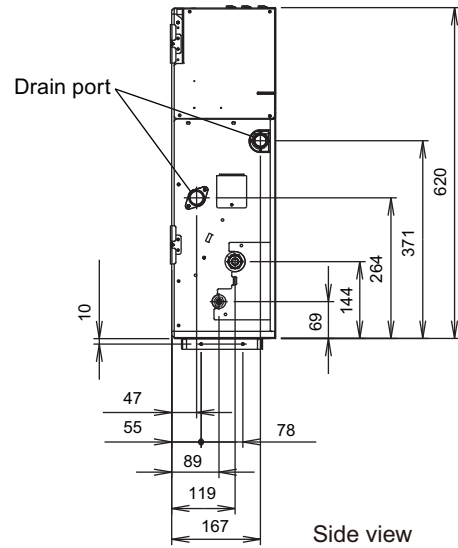

Side view

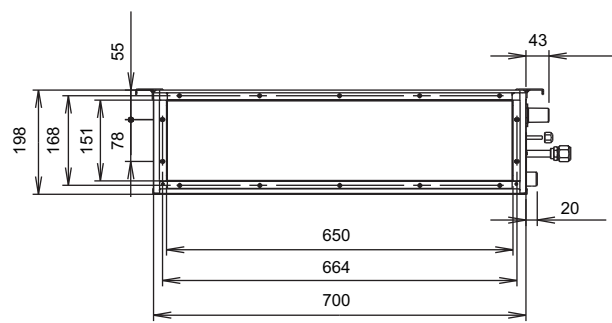

Front view

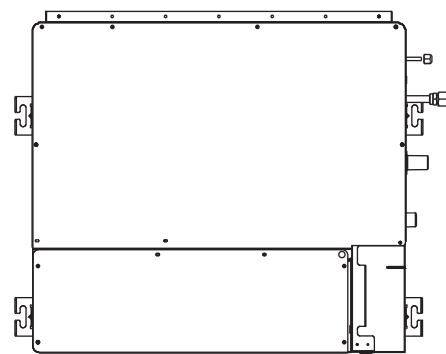

Bottom view

Model: ARYG18LLTB

MULTI TYPE
5, 6 ROOMS TYPE

MULTI TYPE
5, 6 ROOMS TYPE

Unit: mm

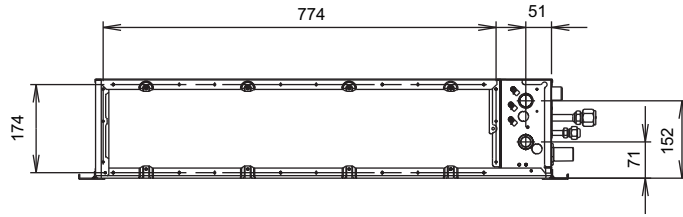

Rear view



View A

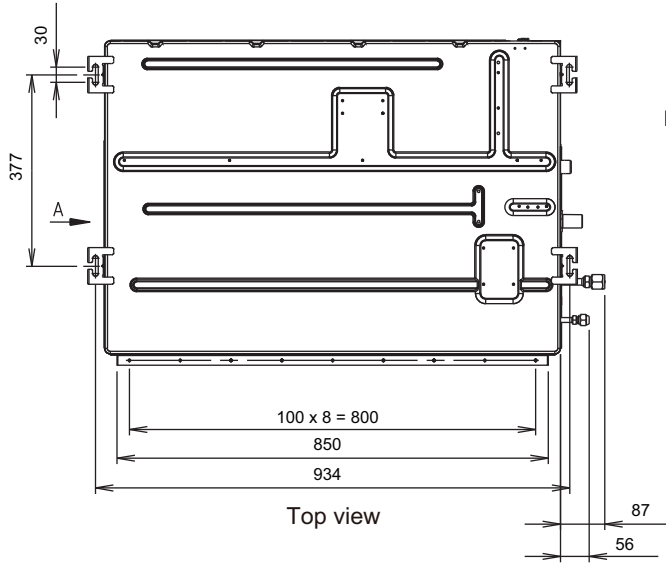

Top view

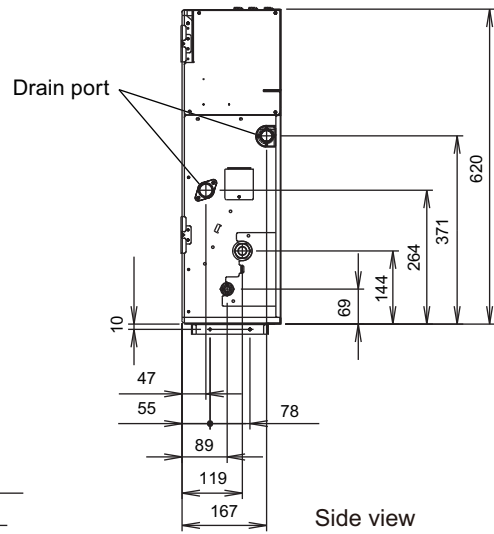

Side view

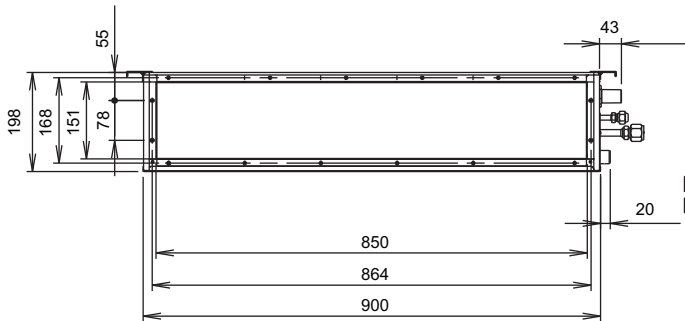

Front view

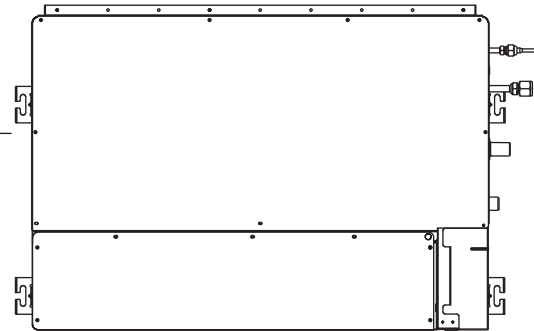

Bottom view

Installation space requirement

Provide sufficient installation space for product safety.

In ceiling-concealed installations:

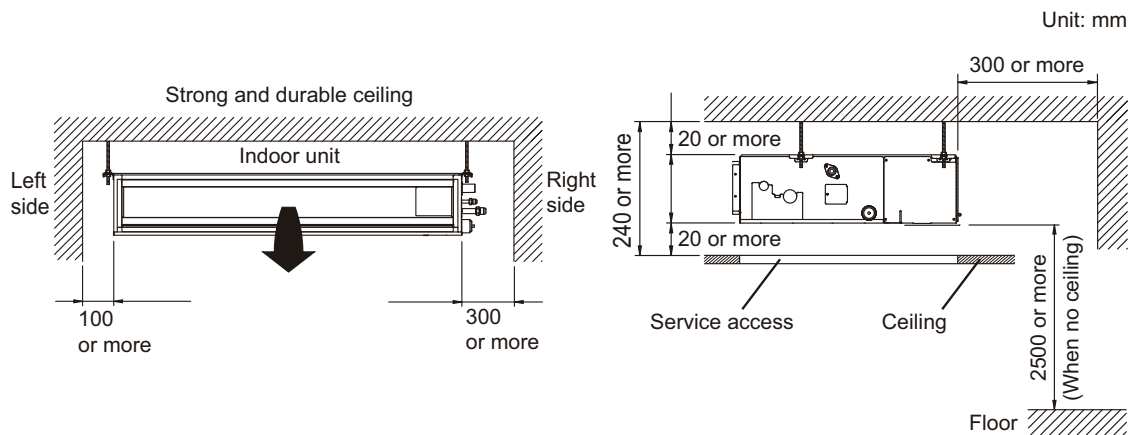

In wall-concealed installations:

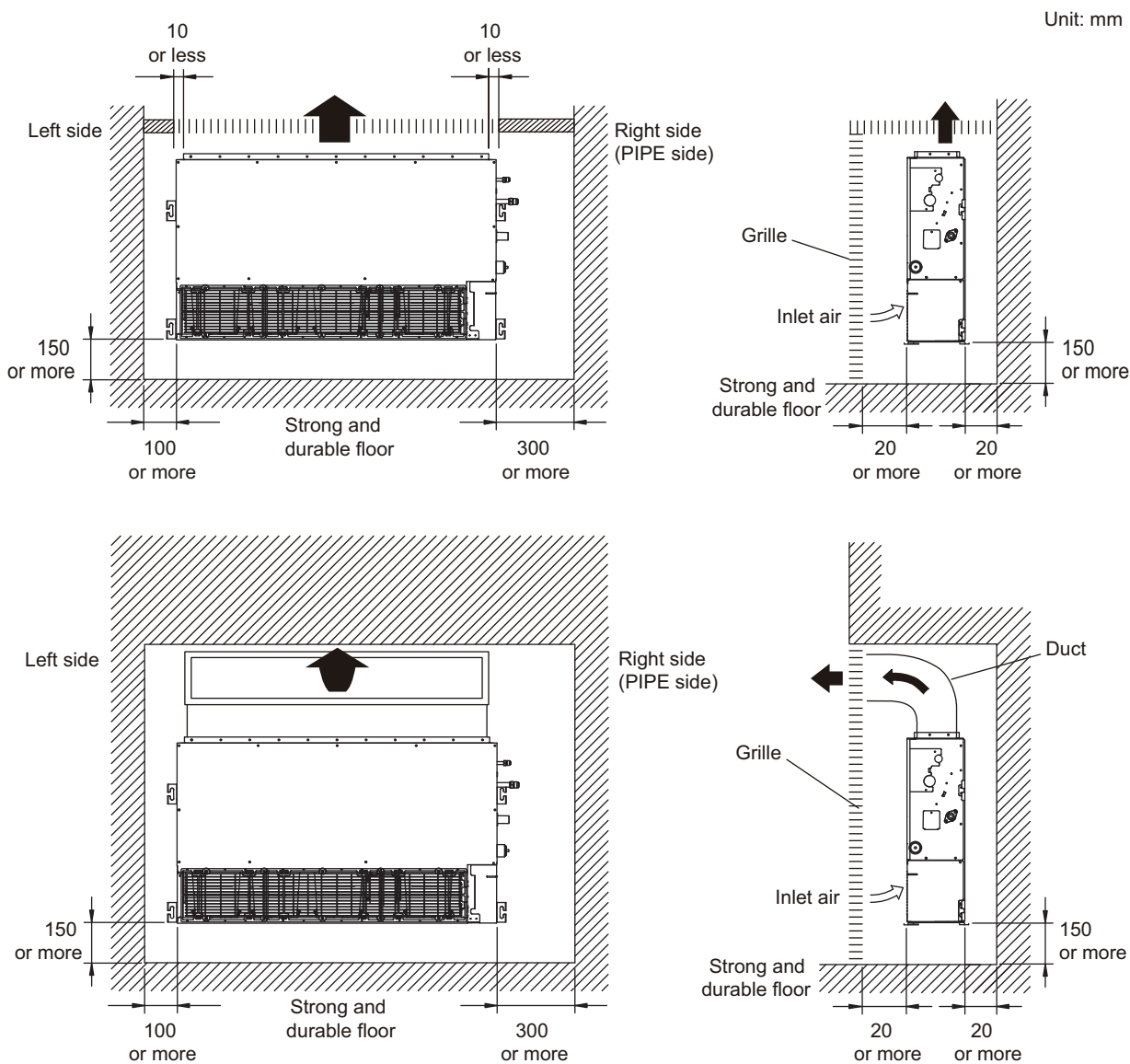

■ Maintenance space requirement

For future maintenance and service access, provide sufficient maintenance space.

NOTE: Do not place any wiring or illumination in the maintenance space, as they will impede service.

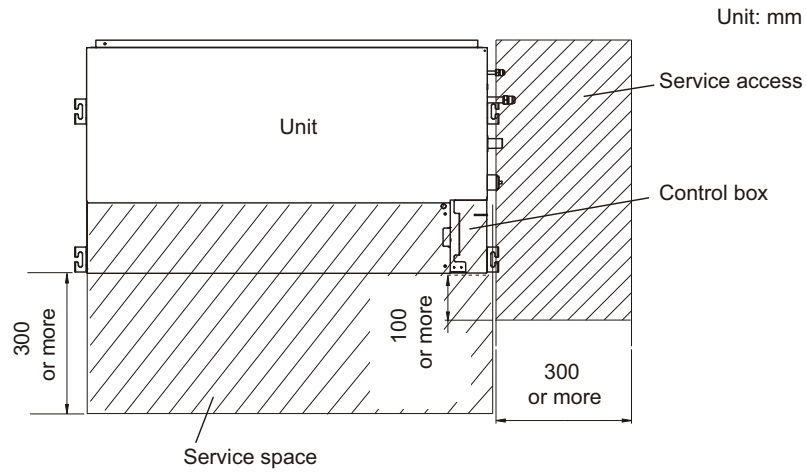

3-4. Wall mounted type

■ Models: ASYG07LMCA, ASYG09LMCA, ASYG12LMCA, and ASYG14LMCA

Unit: mm

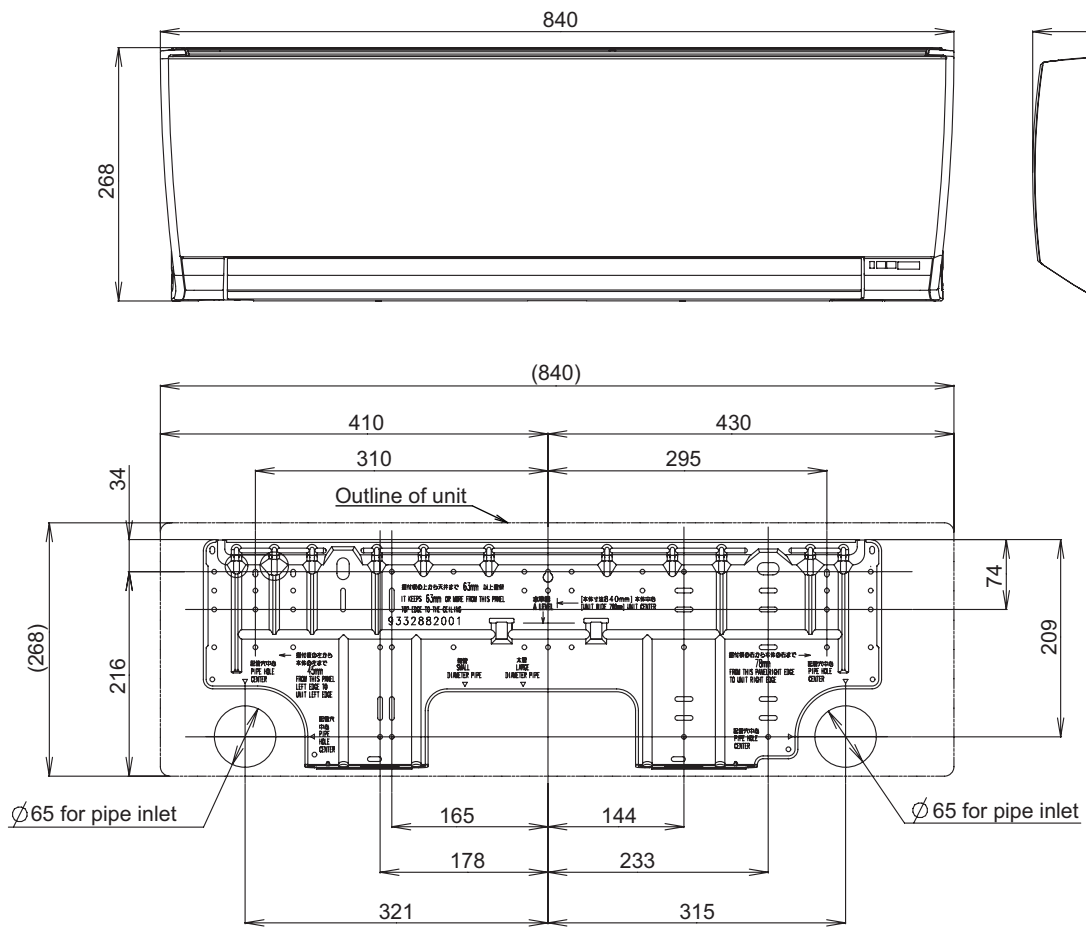

● Installation space

Unit: mm

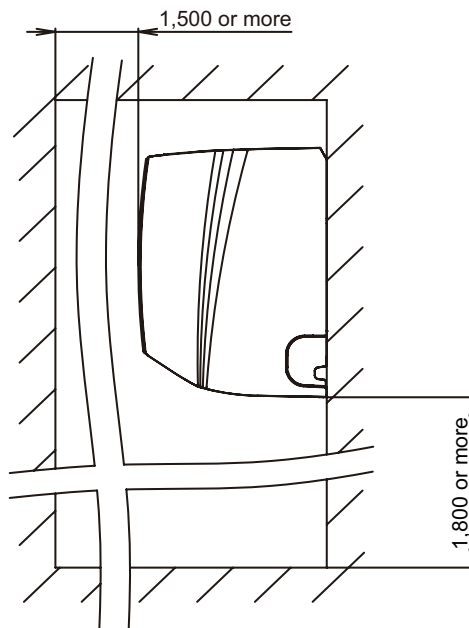
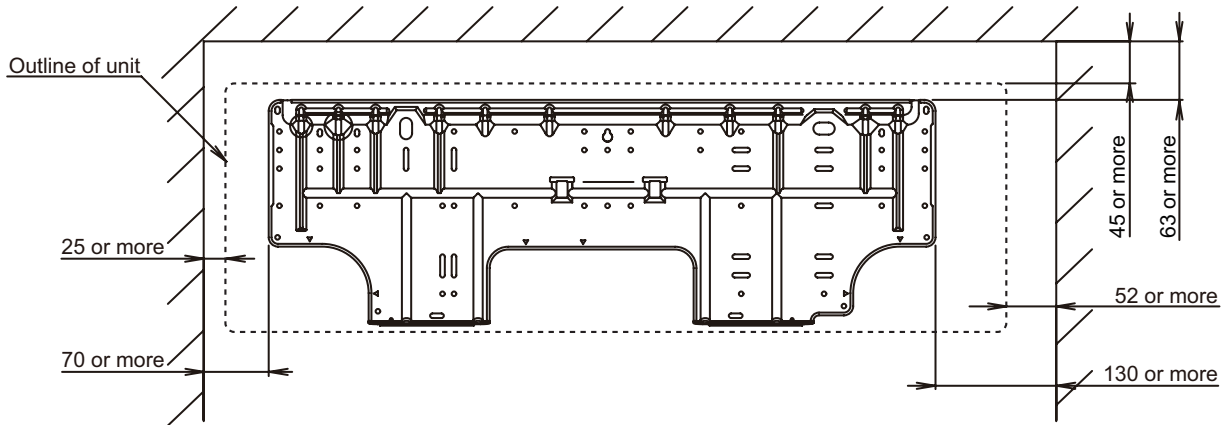

■ Models: ASYG07LMCE, ASYG09LMCE, ASYG12LMCE, and ASYG14LMCE

MULTI TYPE
5, 6 ROOMS TYPE

MULTI TYPE
5, 6 ROOMS TYPE

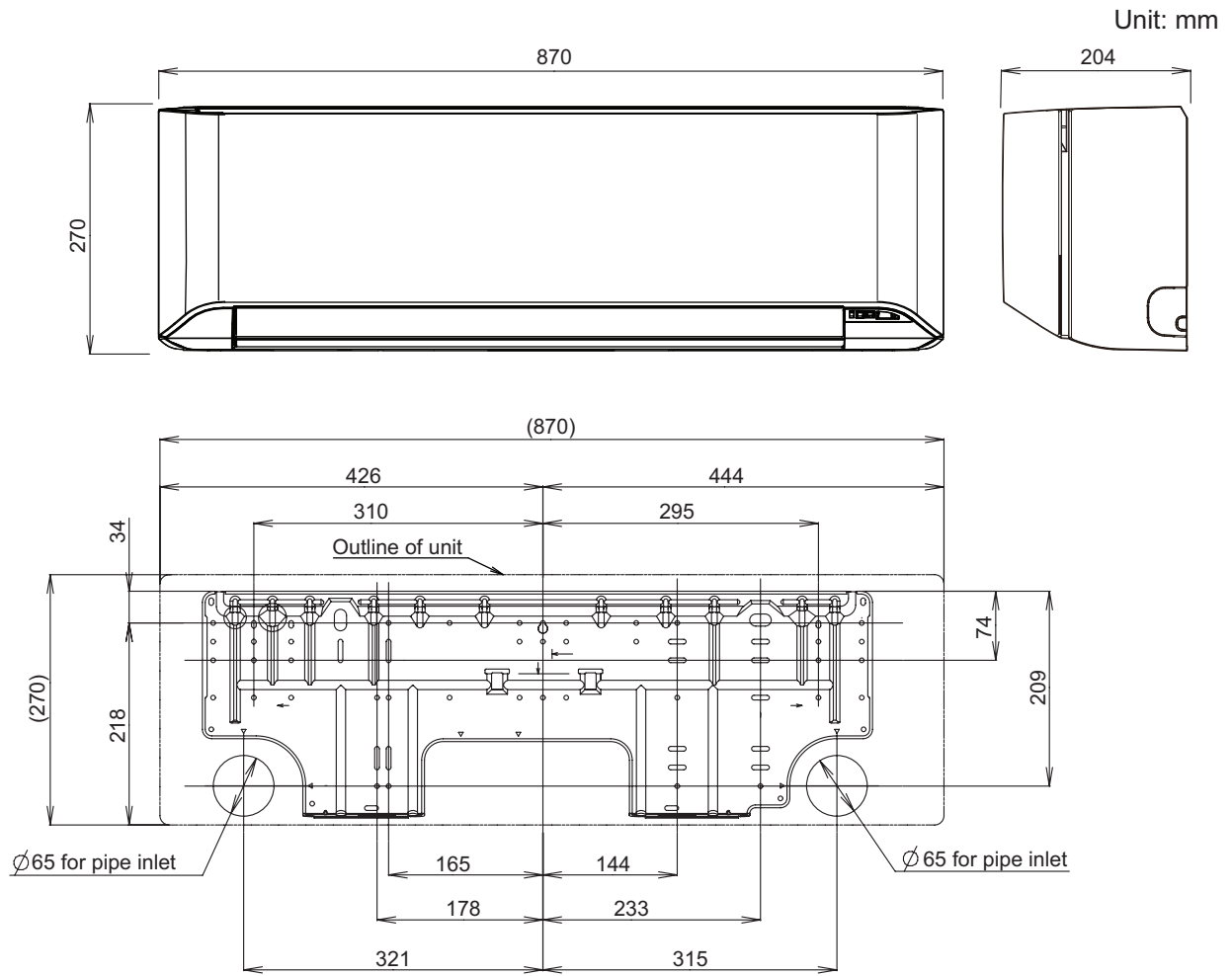

● Installation space requirement

Provide sufficient installation space for product safety.

Unit: mm

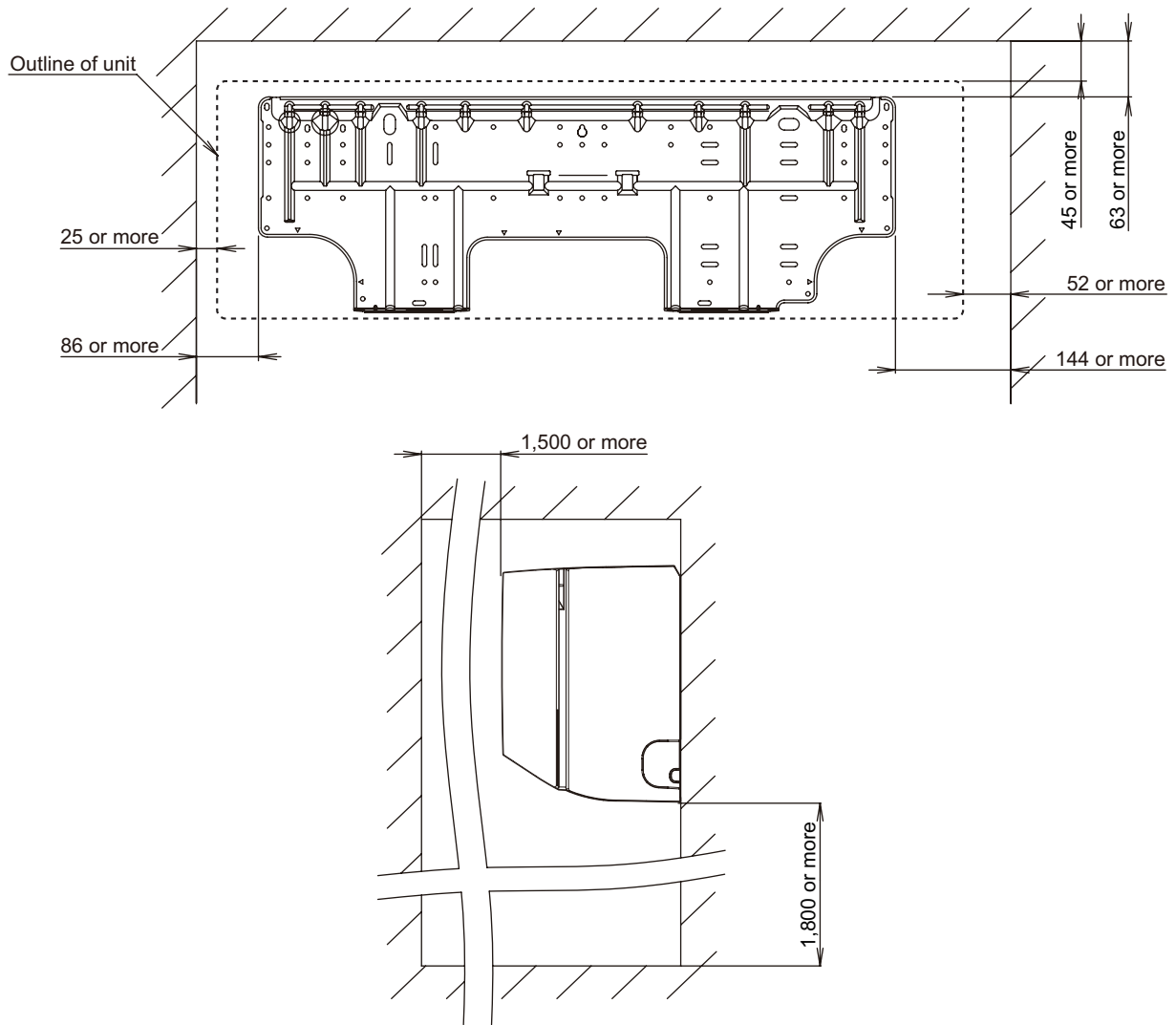

■ Models: ASYG07LUCA, ASYG09LUCA, ASYG12LUCA, and ASYG14LUCA

MULTI TYPE
5, 6 ROOMS TYPE

MULTI TYPE
5, 6 ROOMS TYPE

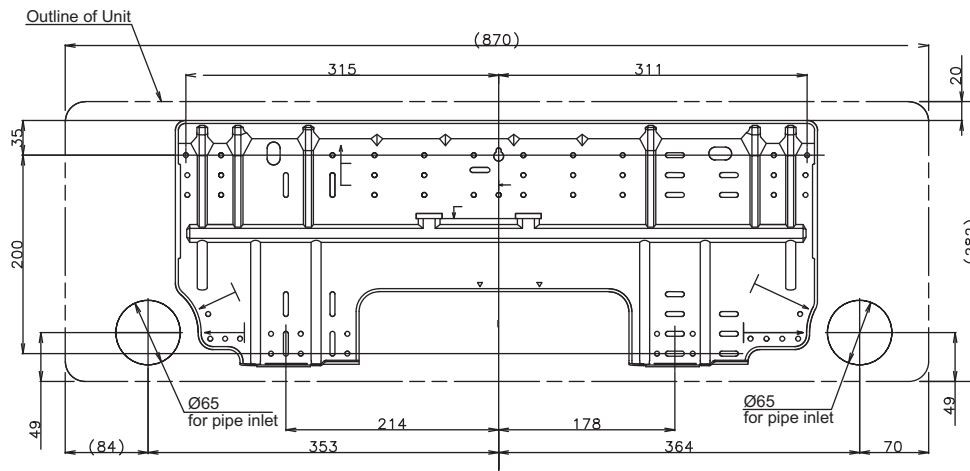

● Installation space

Unit: mm

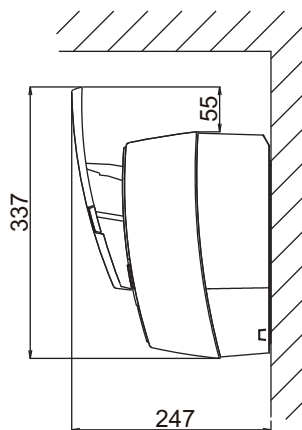
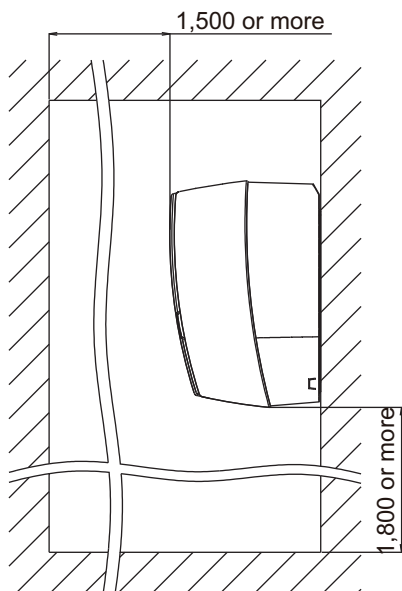
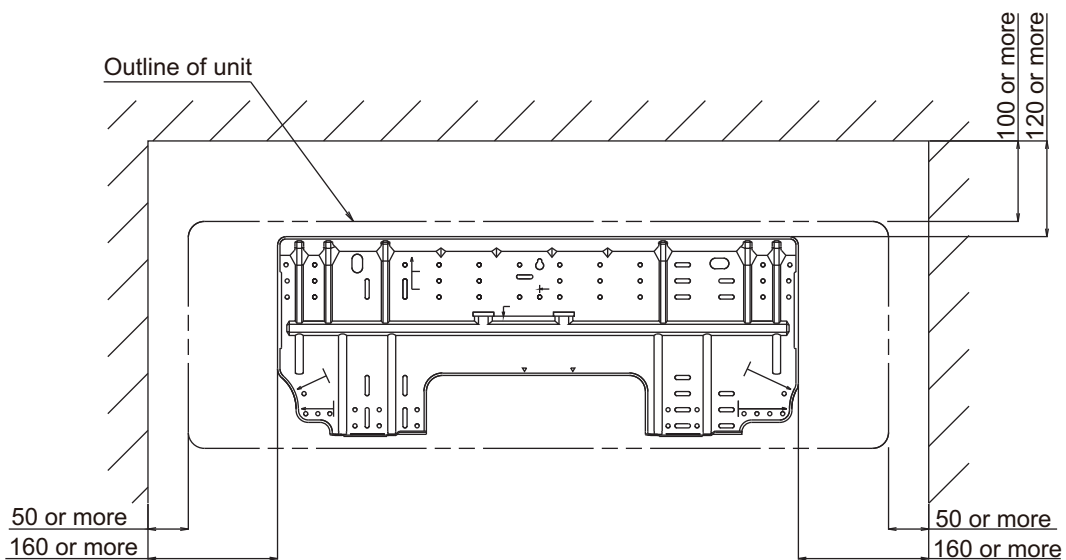

■ Models: ASYG18LFCA, ASYG24LFCA, and ASYG24LFCC

Unit: mm

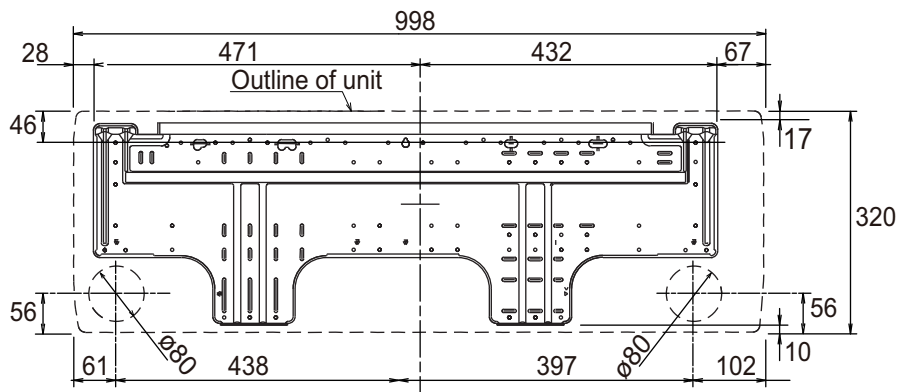
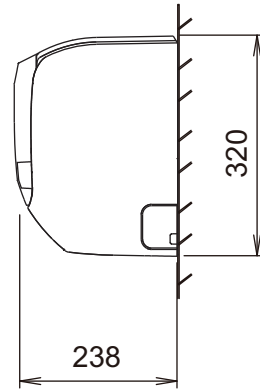
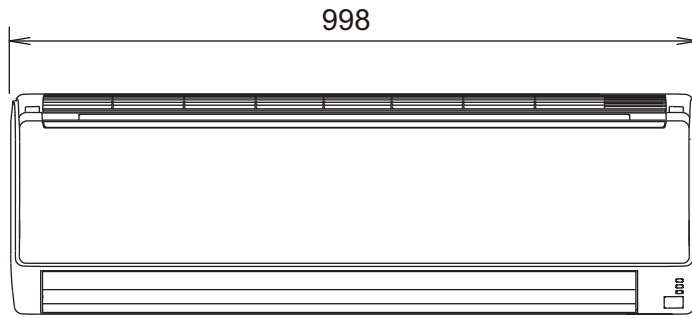

MULTI TYPE
5, 6 ROOMS TYPE

MULTI TYPE
5, 6 ROOMS TYPE

● Installation space

Provide sufficient installation space for product safety.

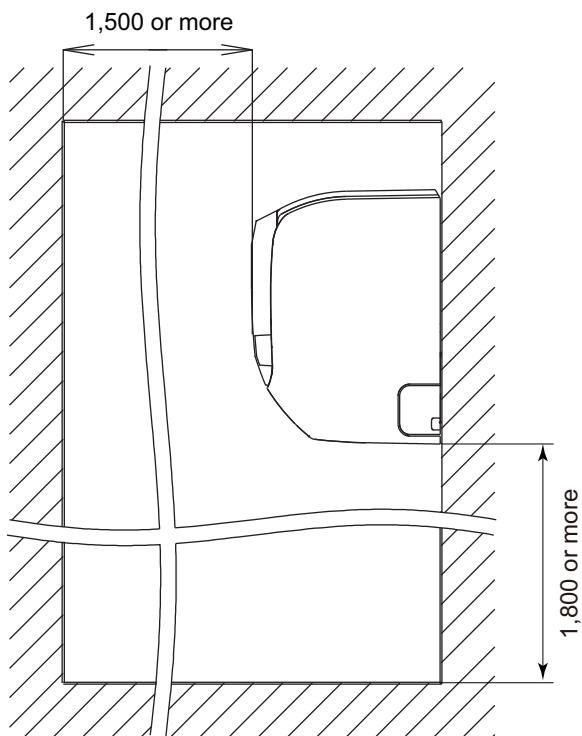
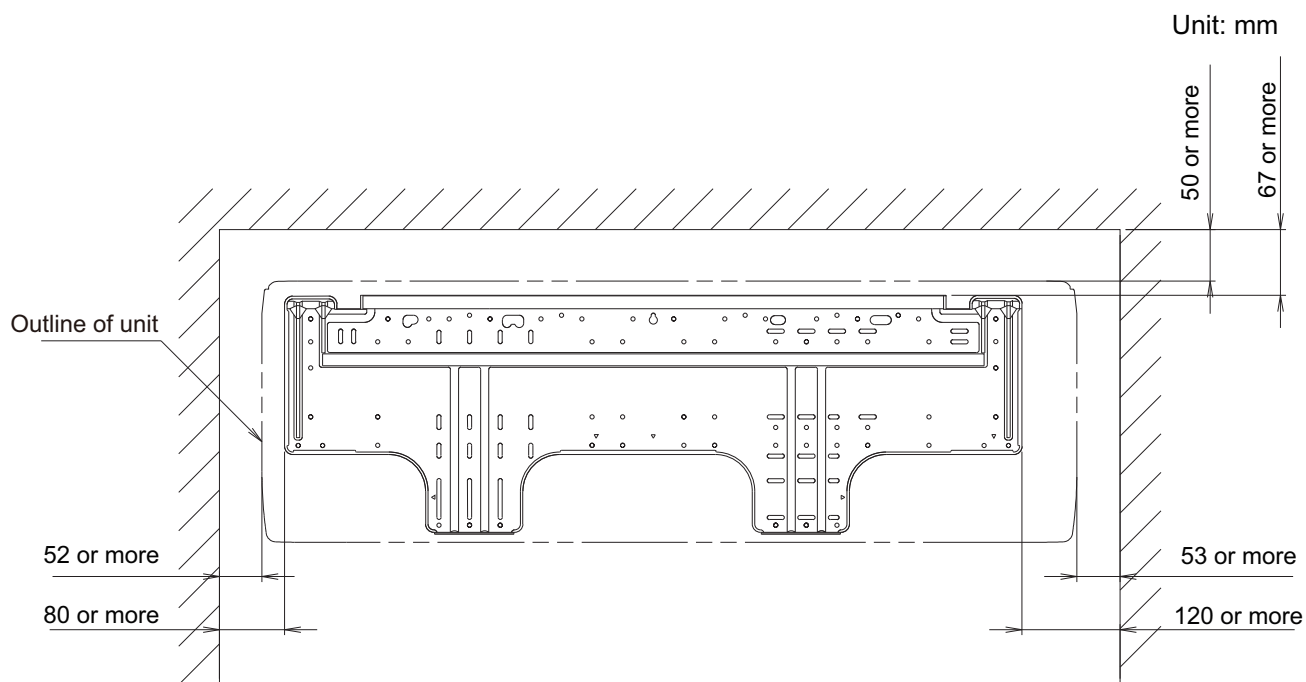

3-5. Floor/Ceiling type

■ Models: ABYG14LVTA and ABYG18LVTB

Unit: mm

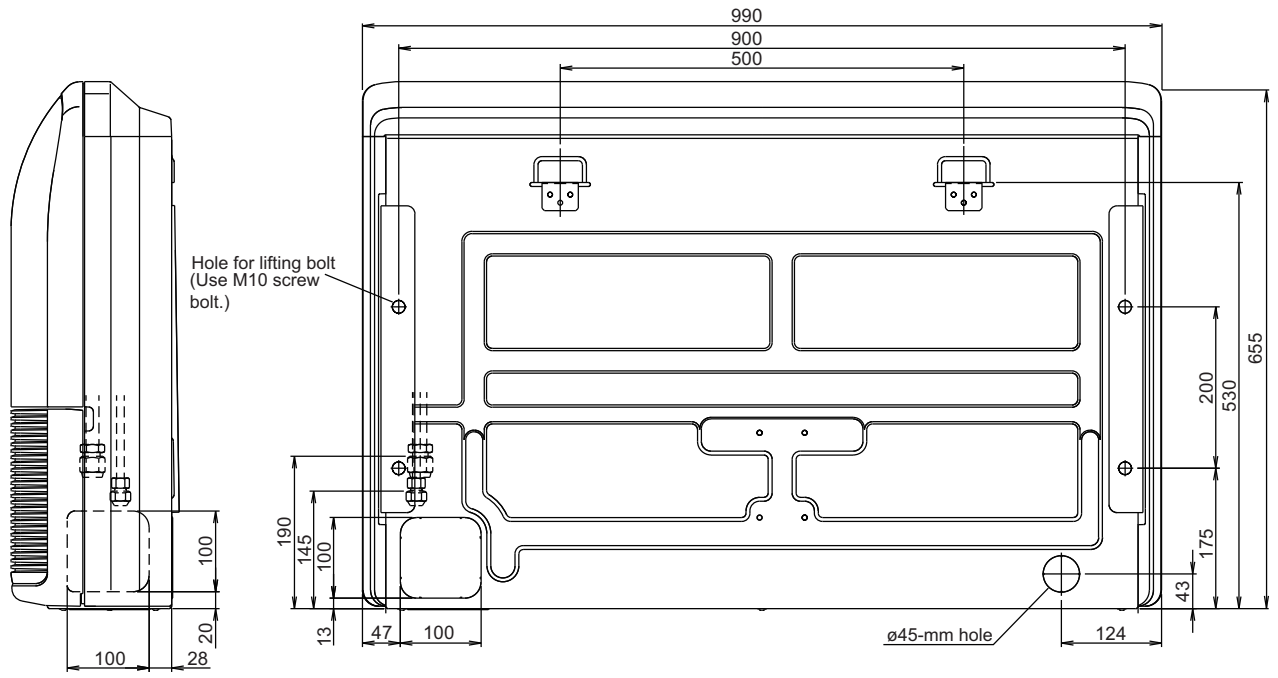

Side view

Rear view

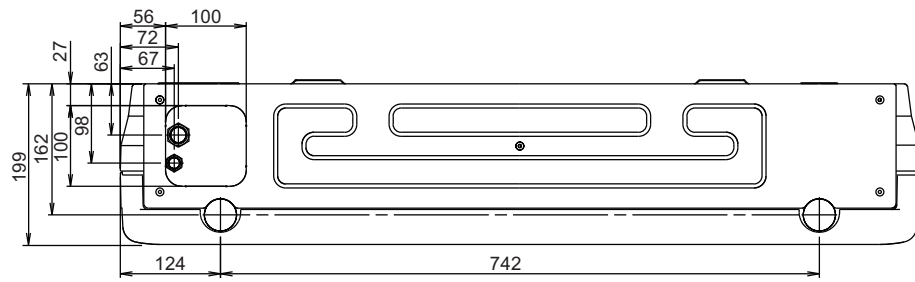

Bottom view

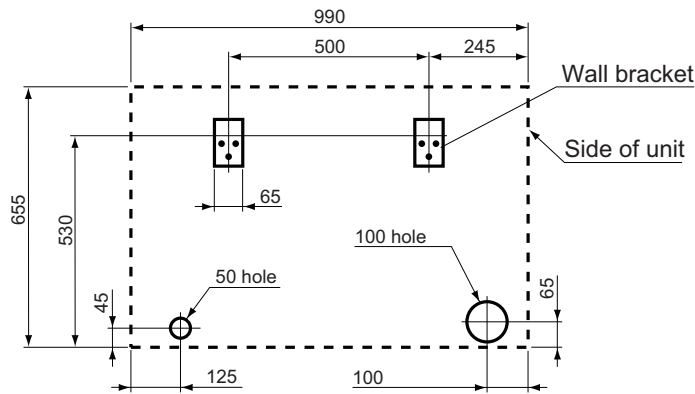

● Installation space

Unit: mm

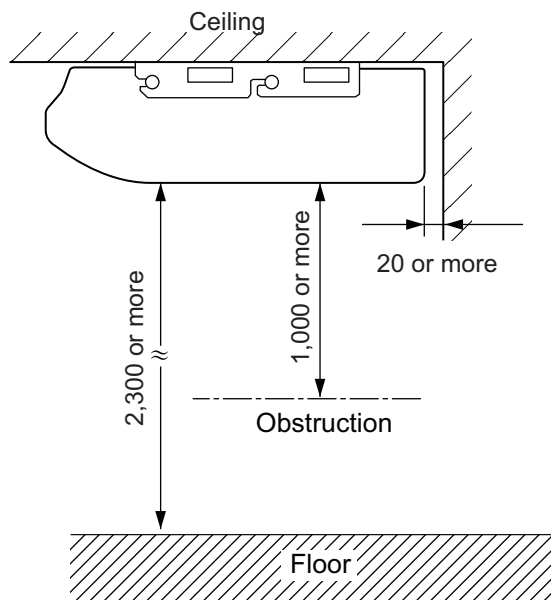
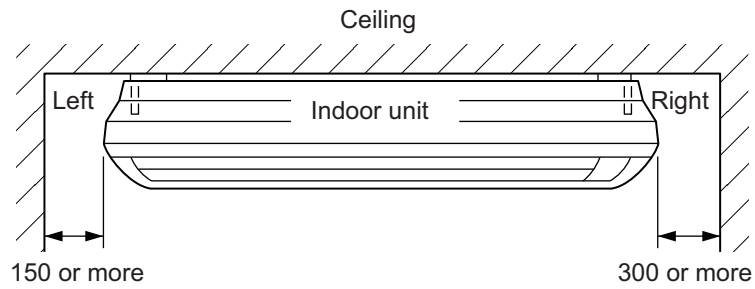
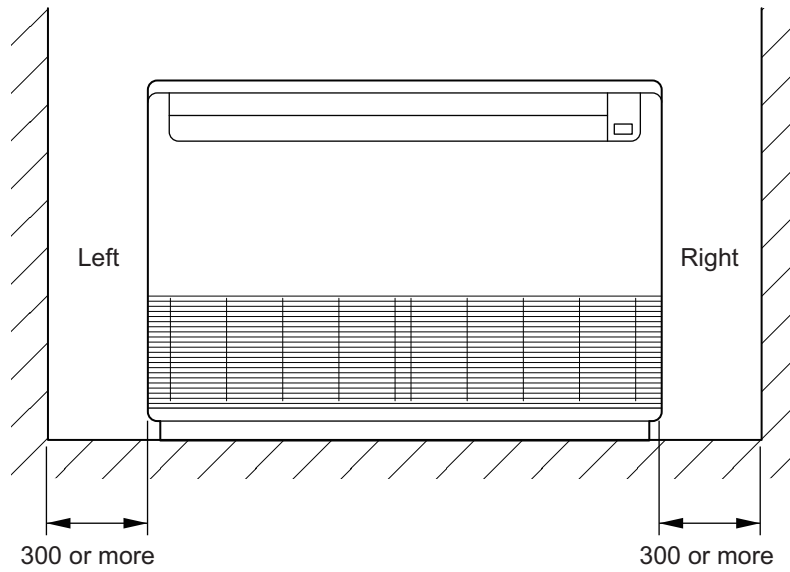

MULTI TYPE
5, 6 ROOMS TYPE

MULTI TYPE
5, 6 ROOMS TYPE

3-6. Floor type

■ Models: AGYG09LVCA, AGYG12LVCA, and AGYG14LVCA

Unit: mm

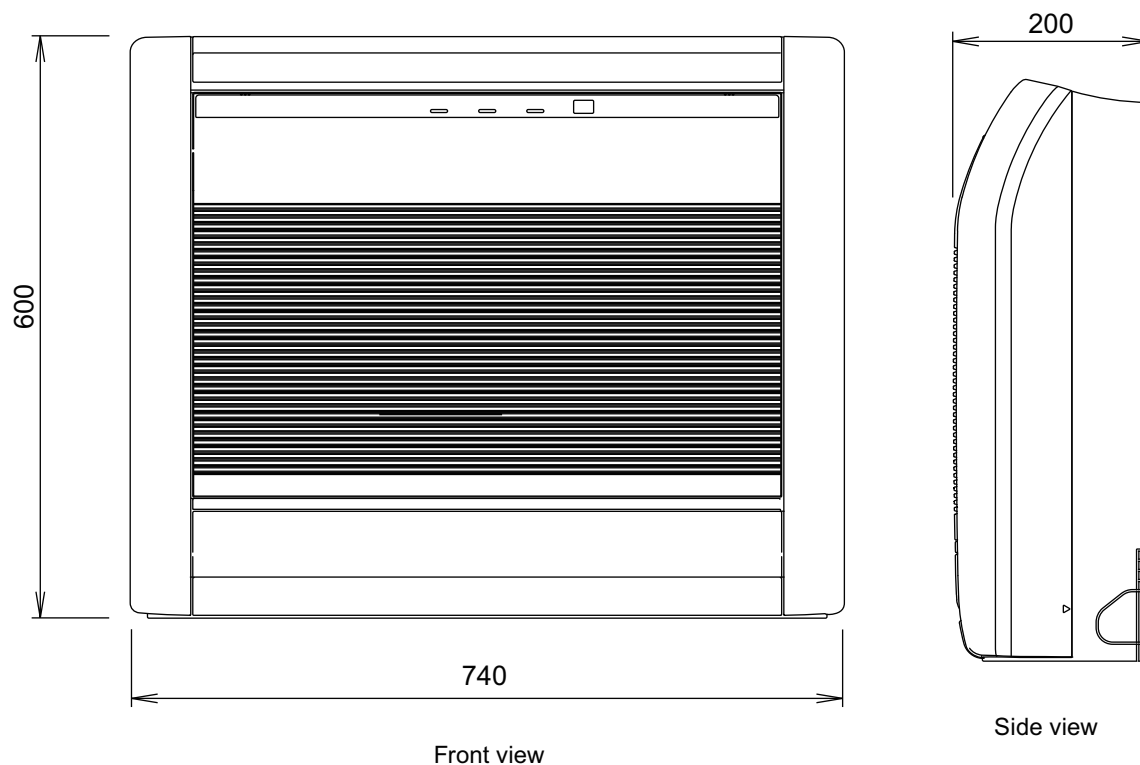

■ Installation space

Unit: mm

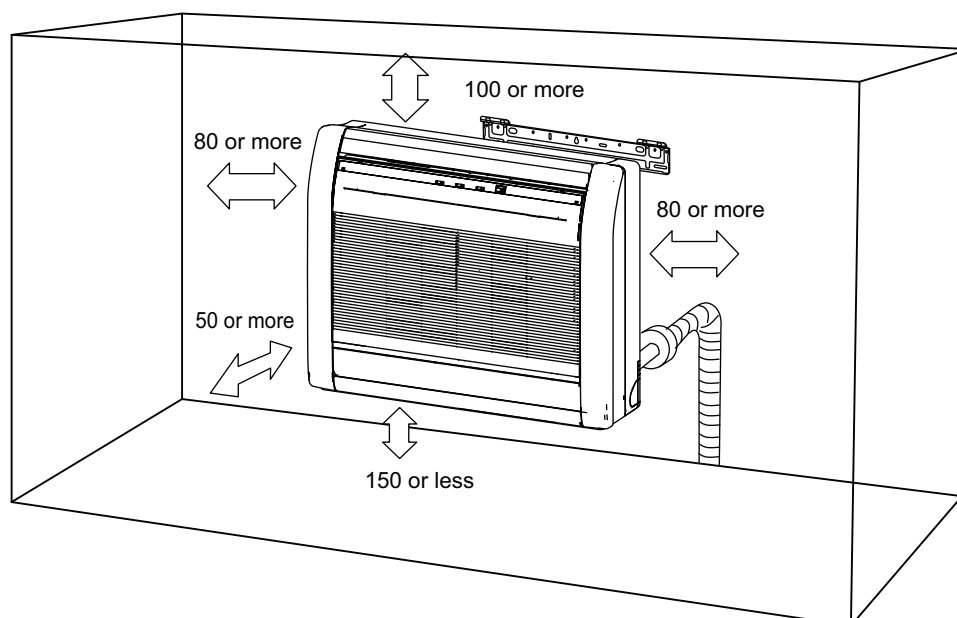

4. Wiring diagrams

4-1. Compact cassette type

■ Models: AUYG07LVLA, AUYG09LVLA, AUYG12LVLB, AUYG14LVLB, and AUYG18LVLB

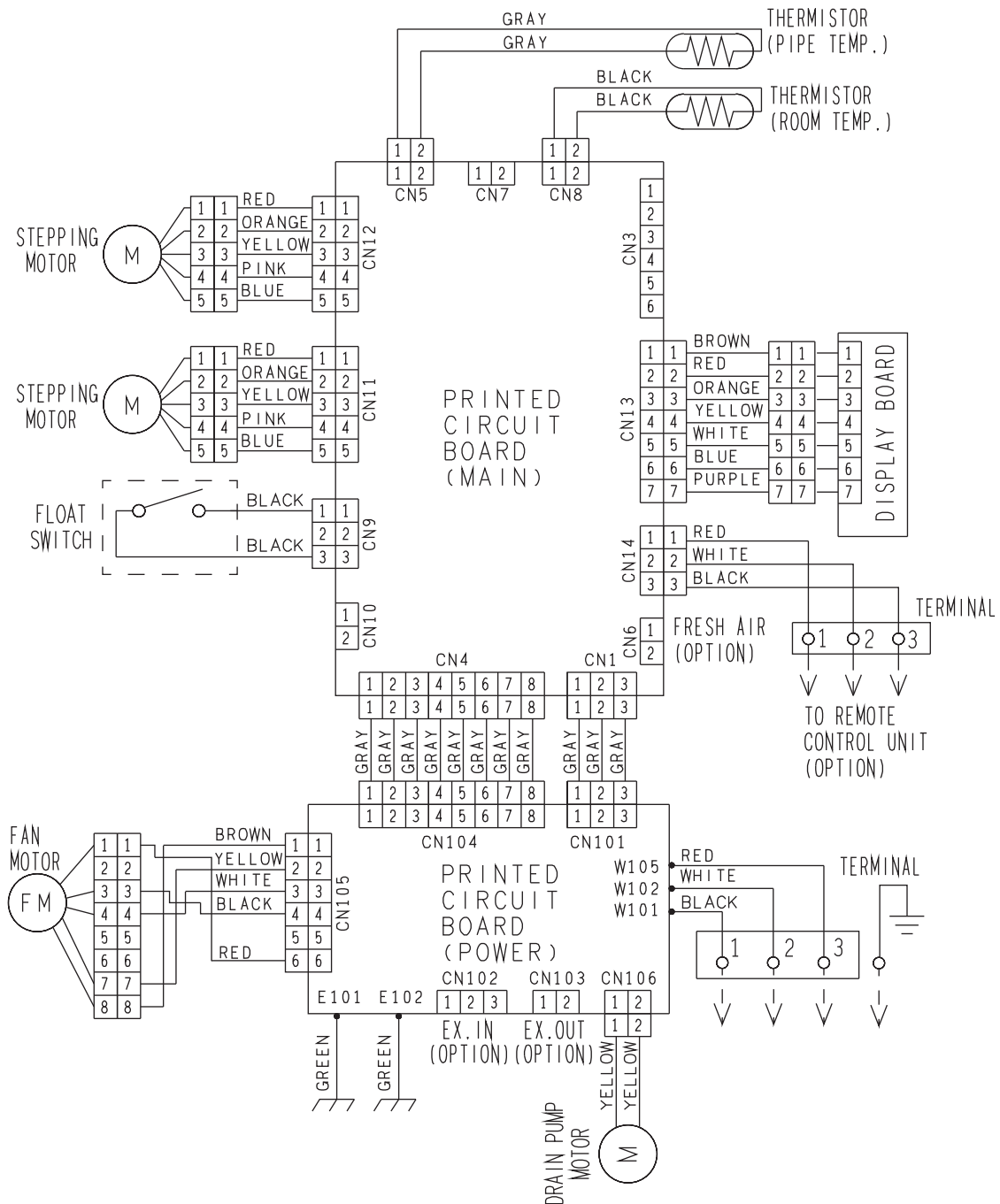

4-2. Mini duct type

Models: ARYG07LSLAP, ARYG09LSLAP, ARYG12LSLAP, ARYG14LSLAP, and ARYG18LSLAP

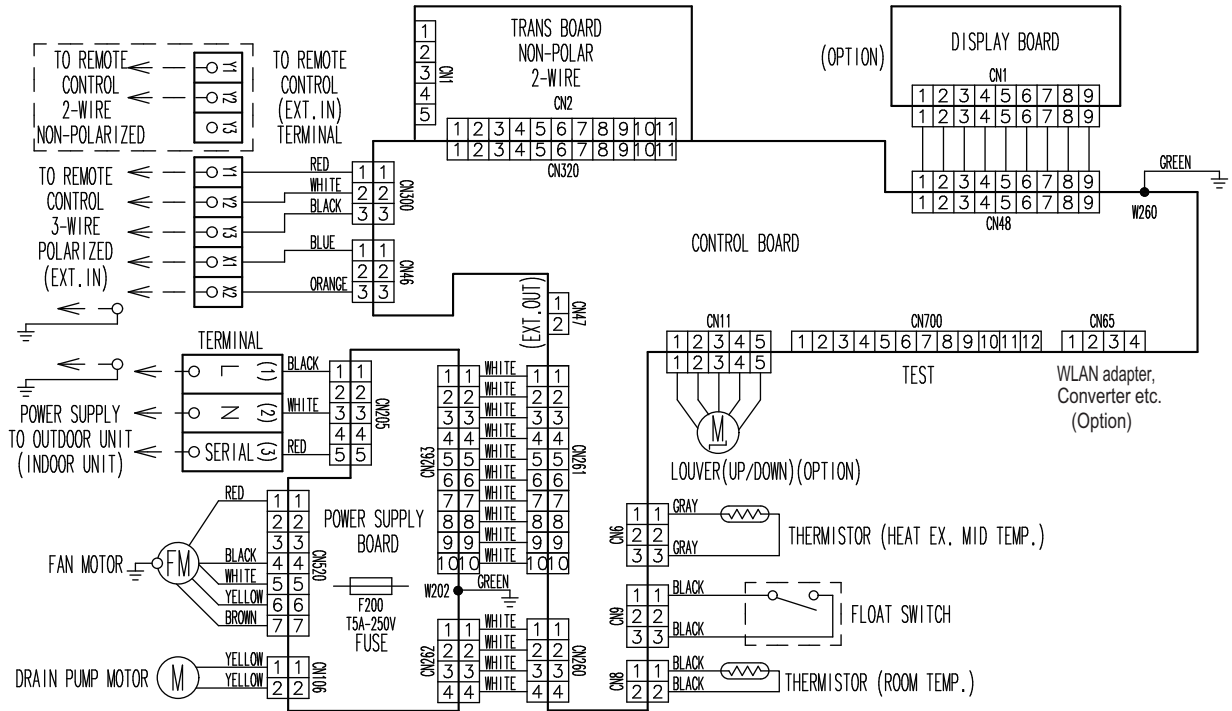

4-3. Slim duct type

■ Models: ARYG07LLTA, ARYG09LLTA, ARYG12LLTB, ARYG14LLTB, and ARYG18LLTB

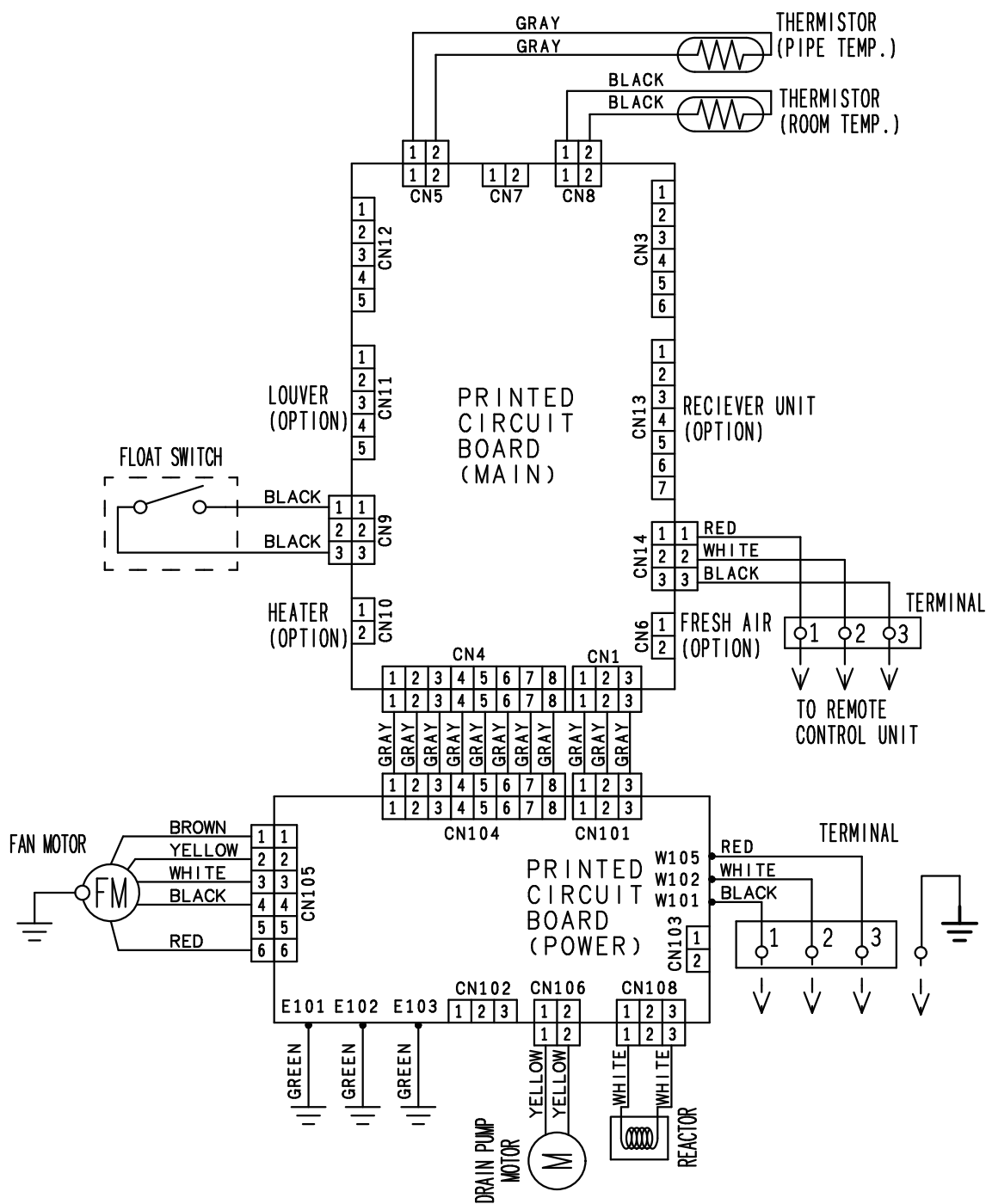

4-4. Wall mounted type

■ Models: ASYG07LUCA, ASYG09LUCA, ASYG12LUCA, and ASYG14LUCA

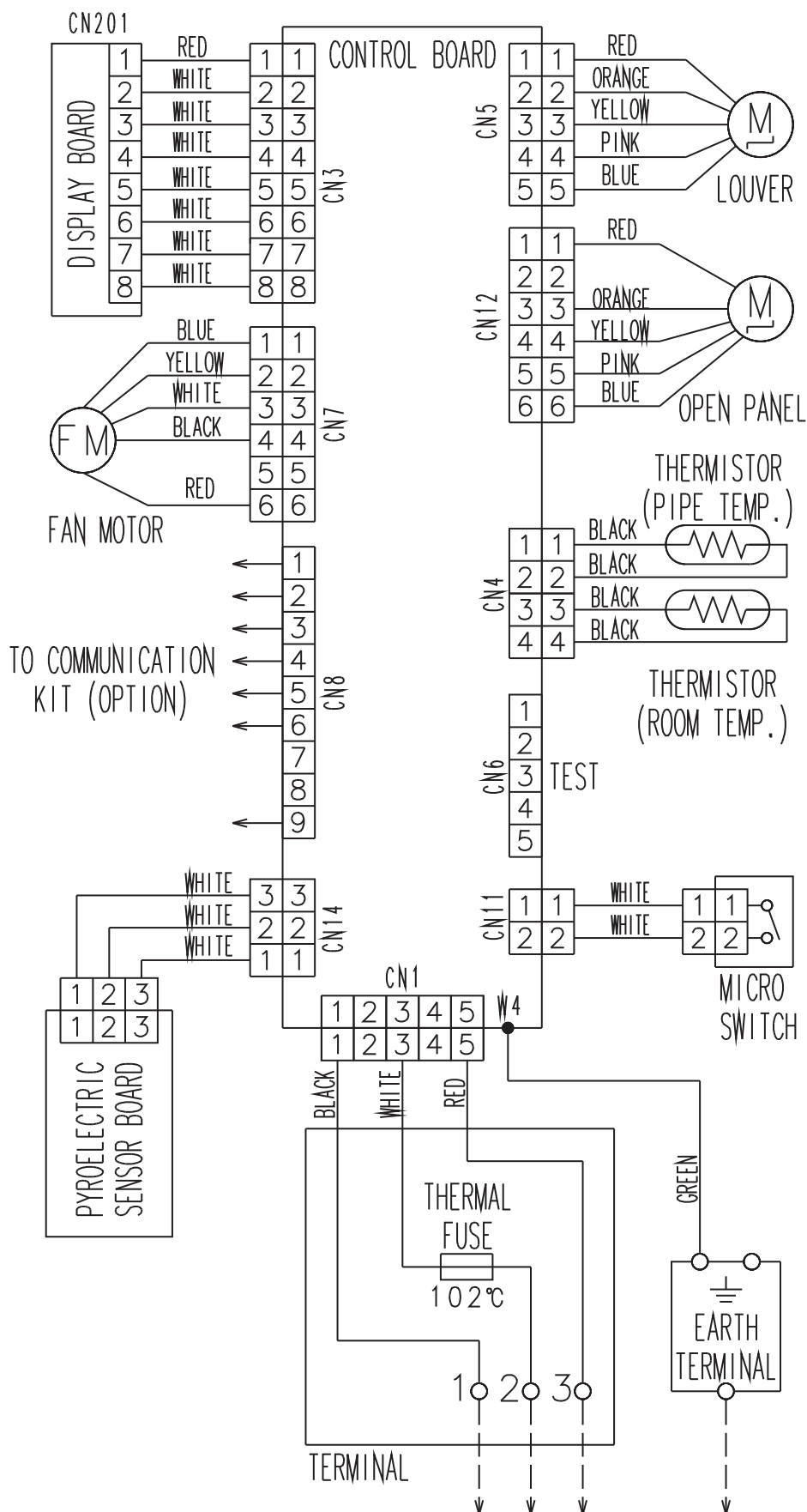

■ Models: ASYG07LMCA, ASYG09LMCA, ASYG12LMCA, ASYG14LMCA, ASYG07LMCE, ASYG09LMCE, ASYG12LMCE and ASYG14LMCE

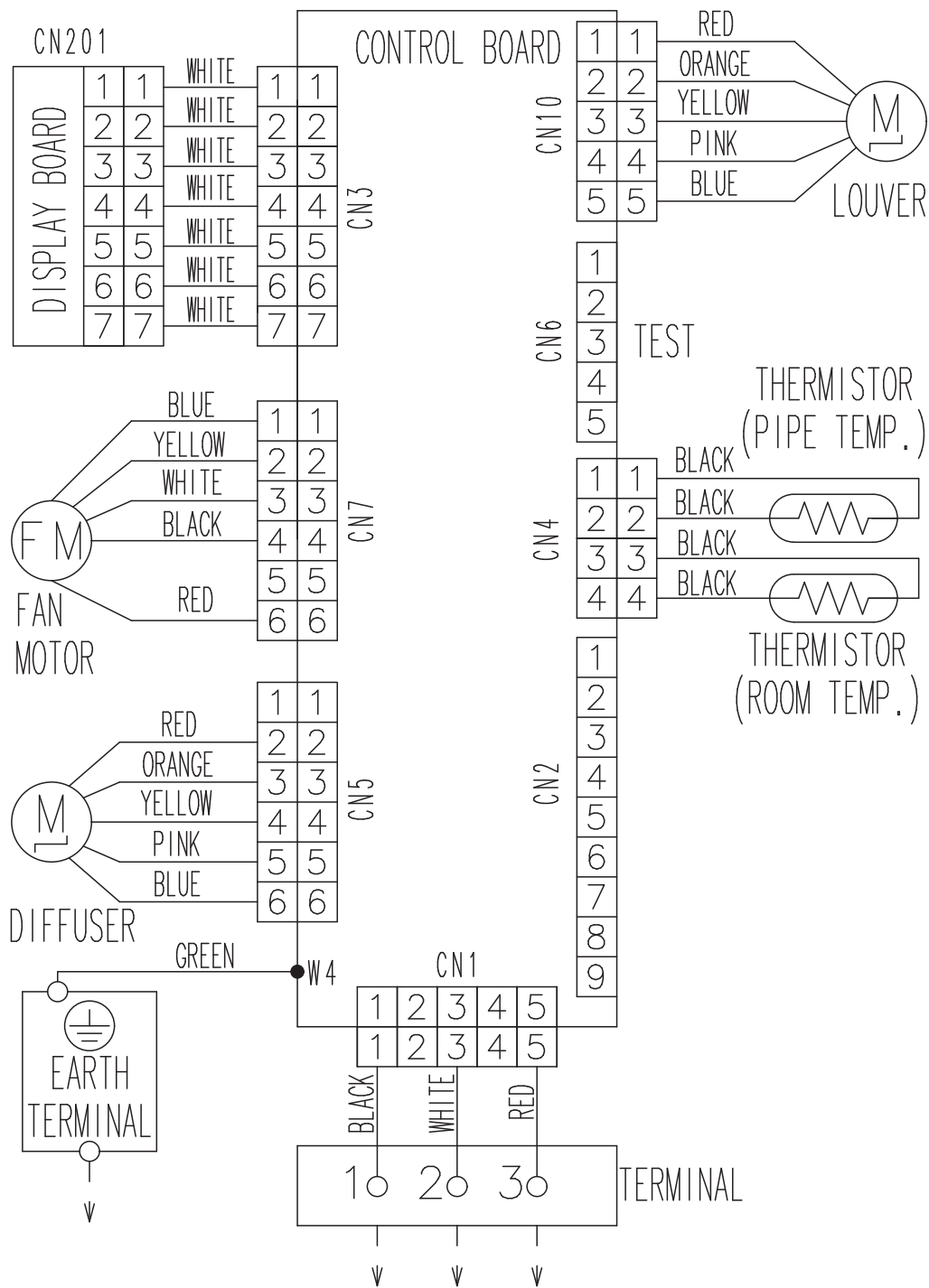

Models: ASYG18LFCA, ASYG24LFCA, and ASYG24LFCC

MULTI TYPE
5, 6 ROOMS TYPE

MULTI TYPE
5, 6 ROOMS TYPE

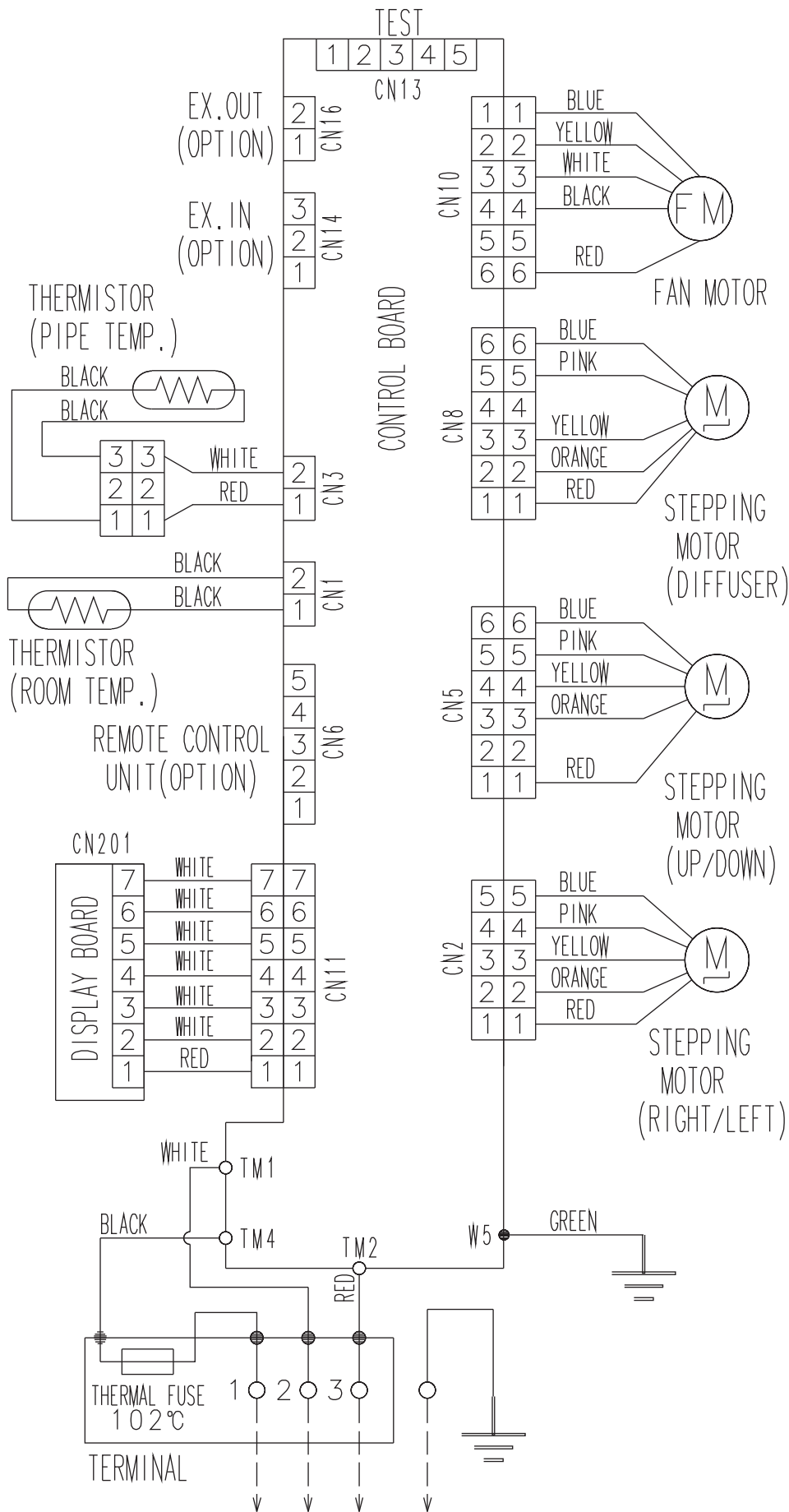

4-5. Floor/Ceiling type

Models: ABYG14LVTA and ABYG18LVTB

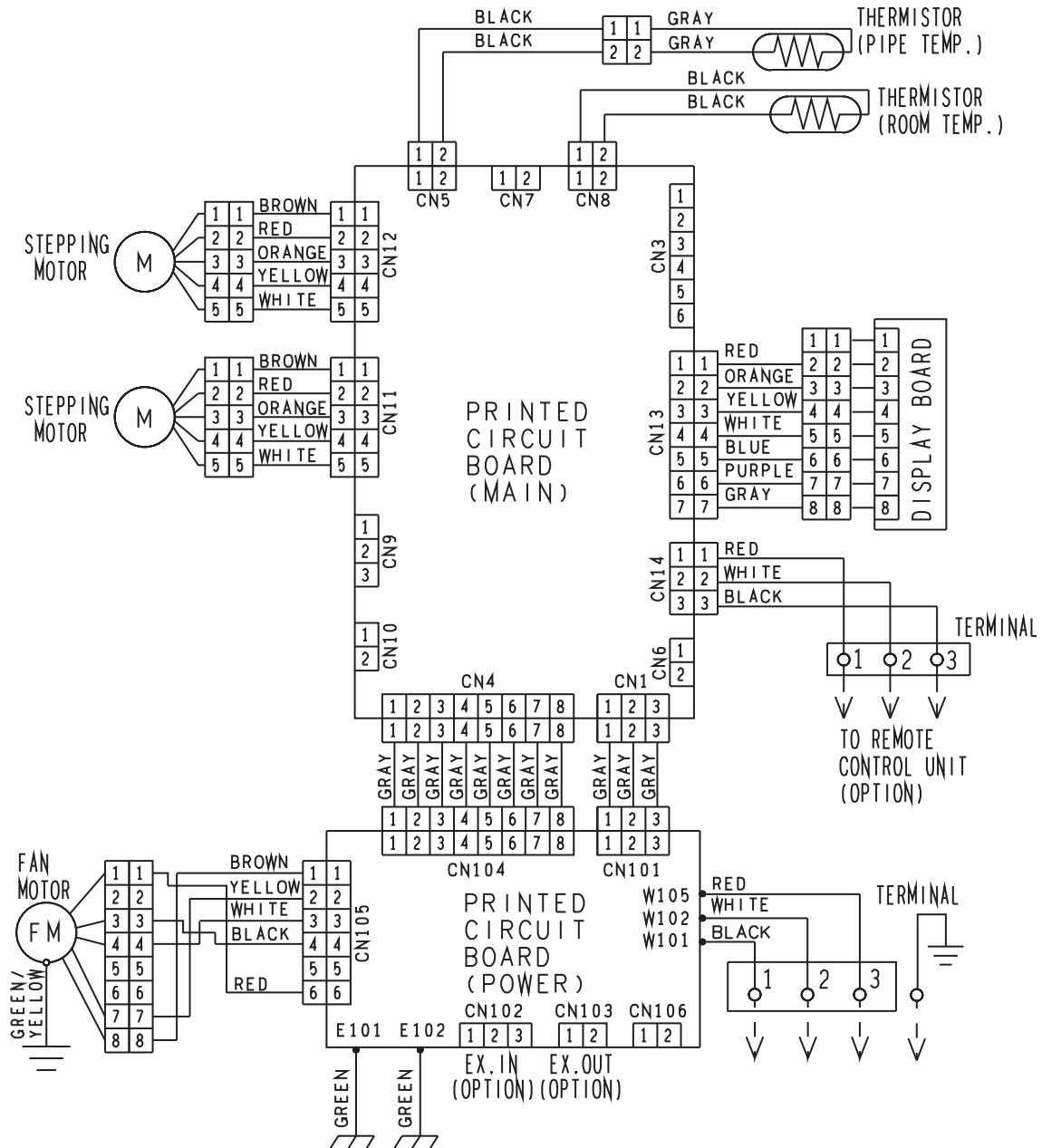

4-6. Floor type

Models: AGYG09LVCA, AGYG12LVCA, and AGYG14LVCA

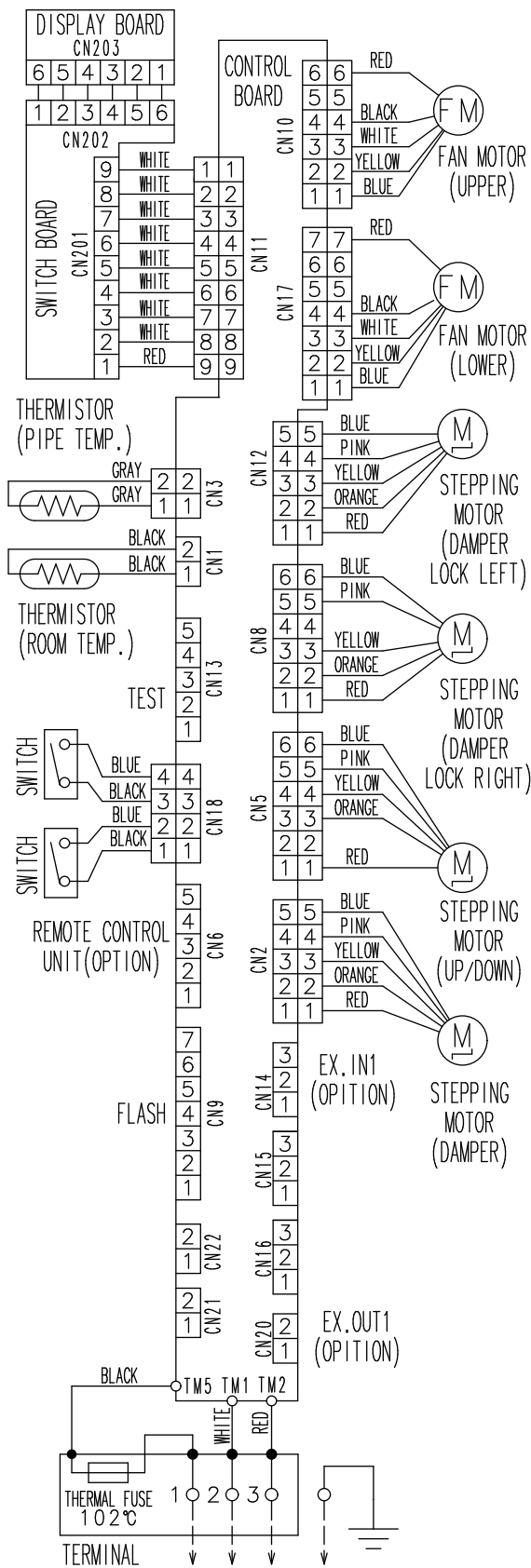

5. Air velocity and temperature distributions

5-1. Compact cassette type

■ Models: AUYG07LVLA and AUYG09LVLA

- Air velocity distribution

Measuring conditions	Fan speed	Operation mode
	HIGH	FAN

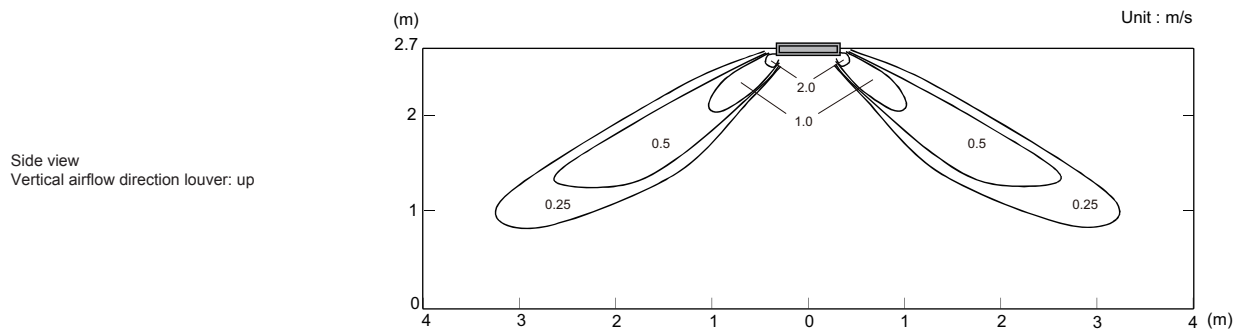
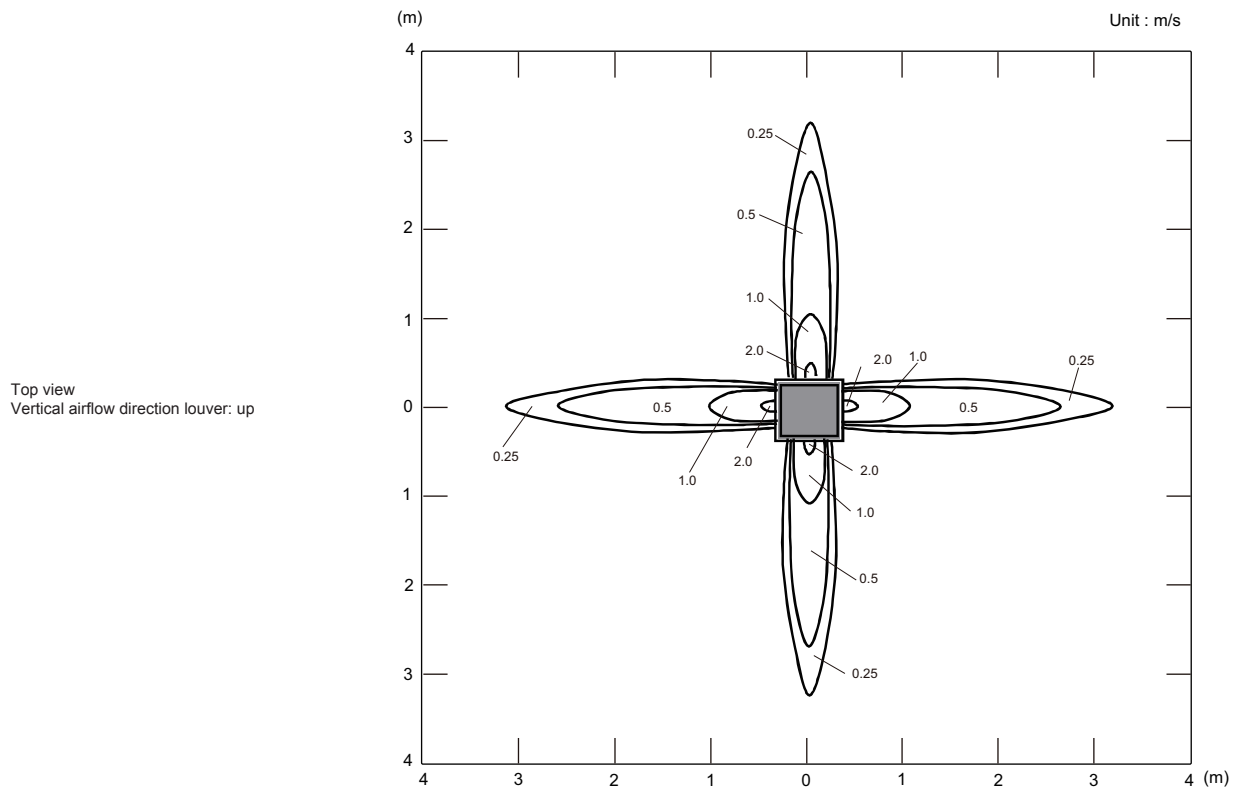

• Air velocity distribution

Measuring conditions	Fan speed	Operation mode	Outlet directions
NOTE: Reference data	HIGH	HEAT	4-way air outlet

Side view
Vertical airflow direction louver: down

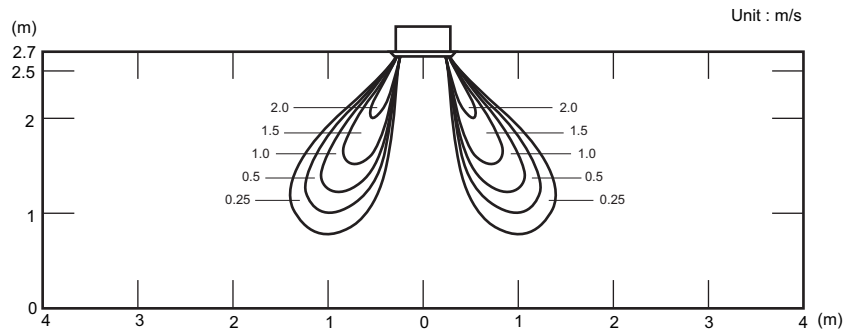

• Air temperature distribution

Measuring conditions	Fan speed	Operation mode	Outlet directions
NOTE: Reference data	HIGH	HEAT	4-way air outlet

Side view
Vertical airflow direction louver: down

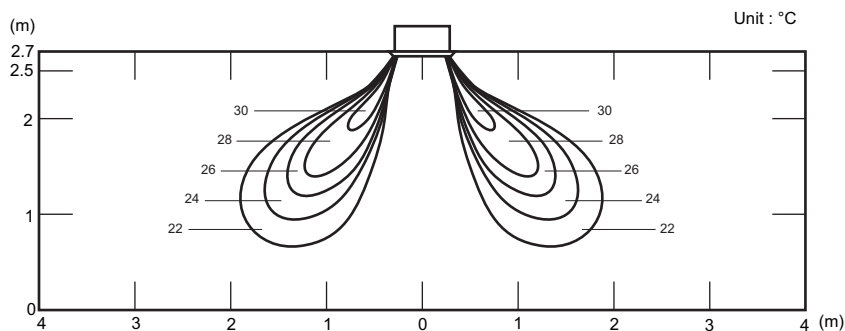

Model: AUYG12LVLB

- Air velocity distribution

Measuring conditions	Fan speed	Operation mode
	HIGH	FAN

Top view
Vertical airflow direction louver: up

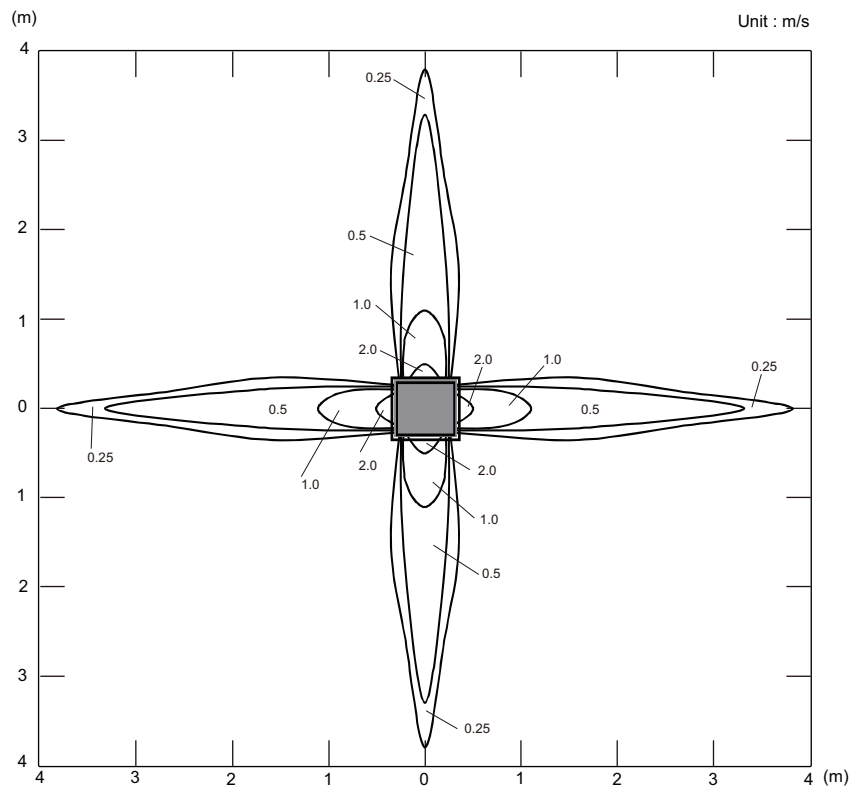

Side view
Vertical airflow direction louver: up

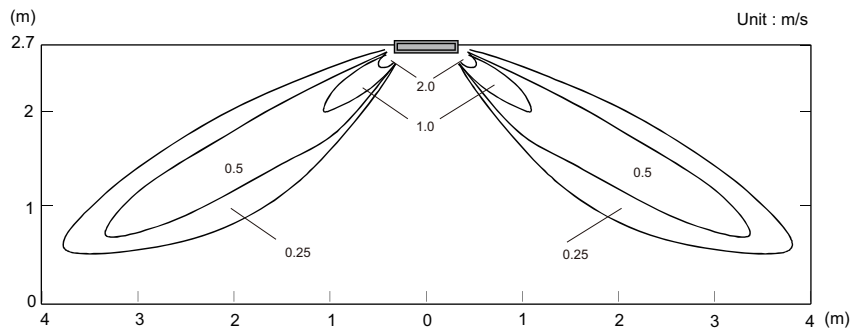

• Air velocity distribution

Measuring conditions	Fan speed	Operation mode	Outlet directions
NOTE:Reference data	HIGH	HEAT	4-way air outlet

Side view
Vertical airflow direction louver: down

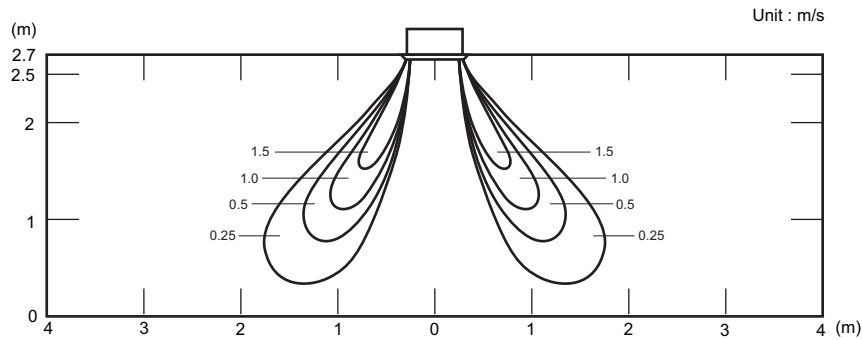

• Air temperature distribution

Measuring conditions	Fan speed	Operation mode	Outlet directions
NOTE:Reference data	HIGH	HEAT	4-way air outlet

Side view
Vertical airflow direction louver: down

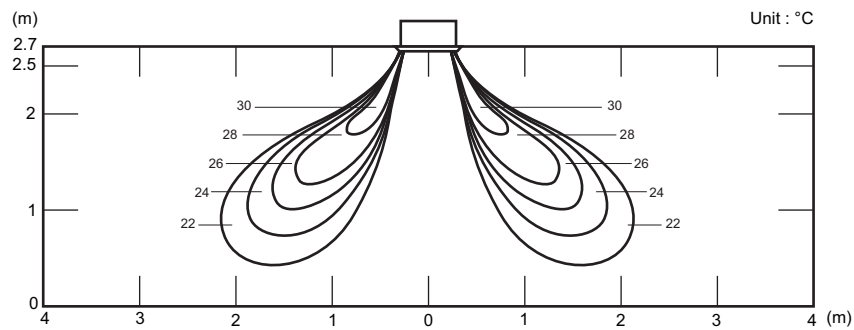

Model: AUYG14LVLB

- Air velocity distribution

Measuring conditions	Fan speed	Operation mode
	HIGH	FAN

Top view
Vertical airflow direction louver: up

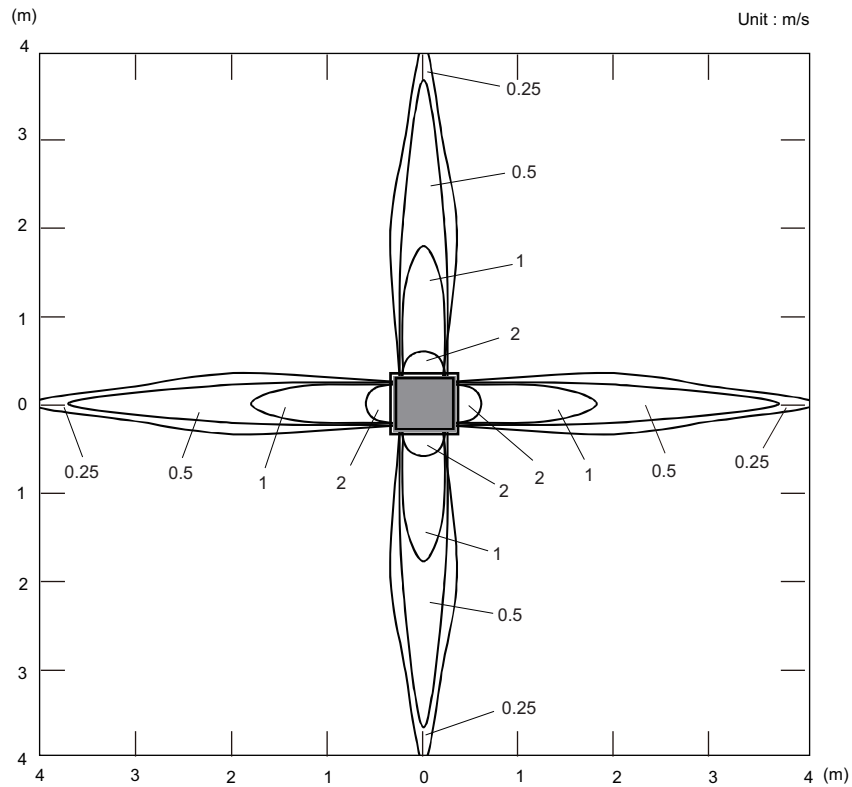

Side view
Vertical airflow direction louver: up

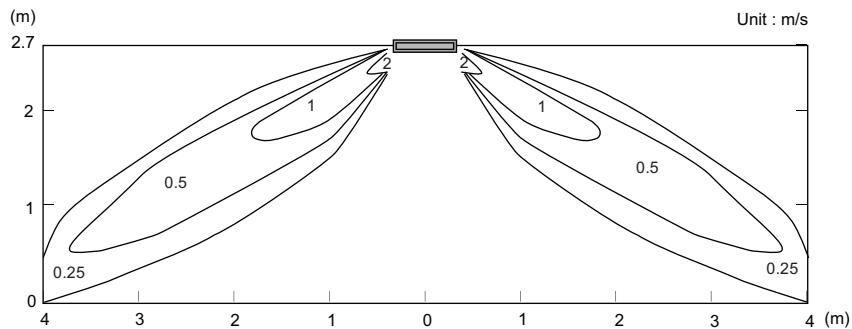

• Air velocity distribution

Measuring conditions	Fan speed	Operation mode	Outlet directions
NOTE:Reference data	HIGH	HEAT	4-way air outlet

Side view
Vertical airflow direction louver: down

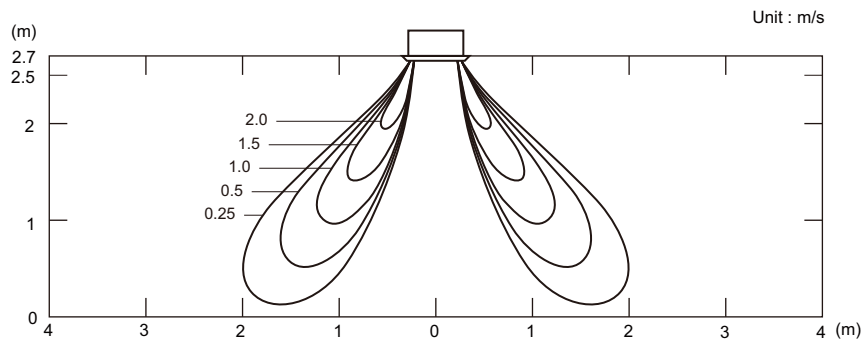

• Air temperature distribution

Measuring conditions	Fan speed	Operation mode	Outlet directions
NOTE:Reference data	HIGH	HEAT	4-way air outlet

Side view
Vertical airflow direction louver: down

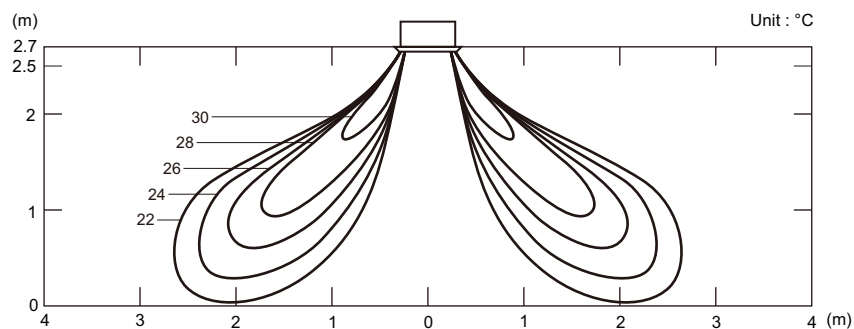

Model: AUYG18LVLB

- Air velocity distribution

Measuring conditions	Fan speed	Operation mode
	HIGH	FAN

Top view
Vertical airflow direction louver: up

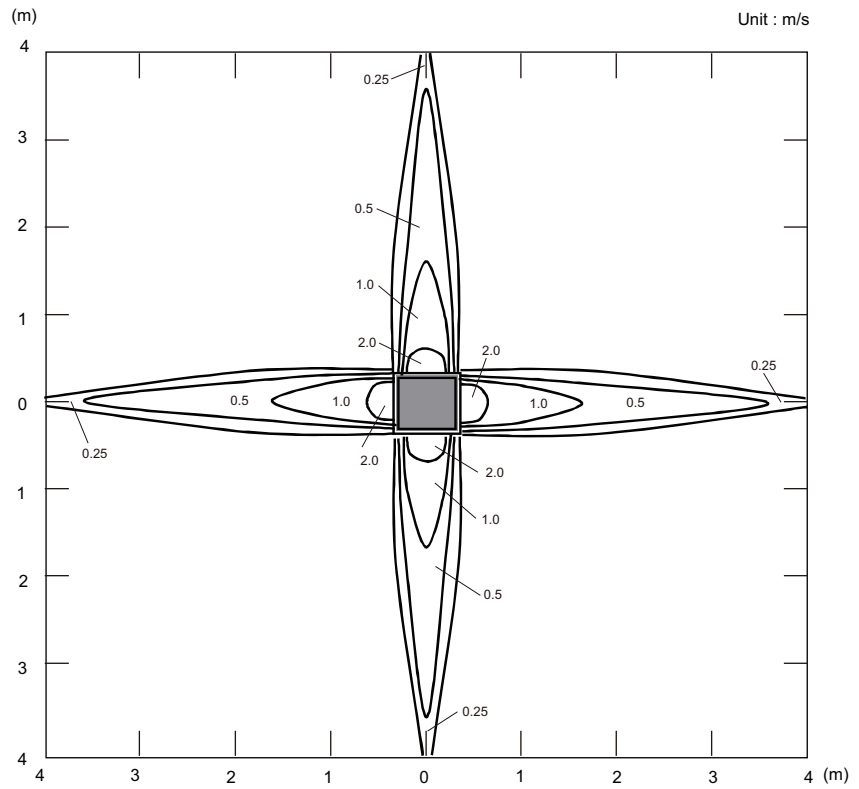

Side view
Vertical airflow direction louver: up

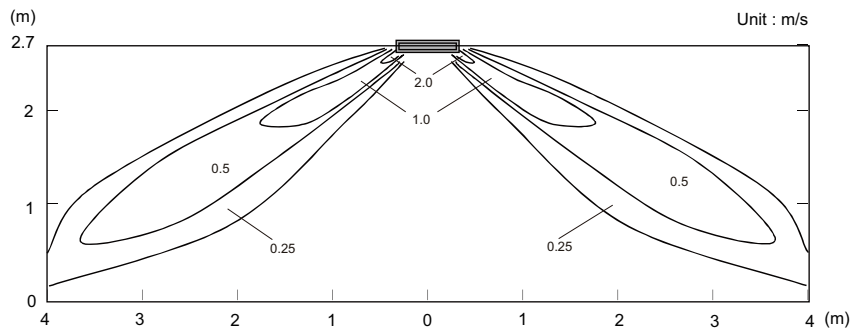

• Air velocity distribution

Measuring conditions	Fan speed	Operation mode	Outlet directions
NOTE:Reference data	HIGH	HEAT	4-way air outlet

Side view
Vertical airflow direction louver: down

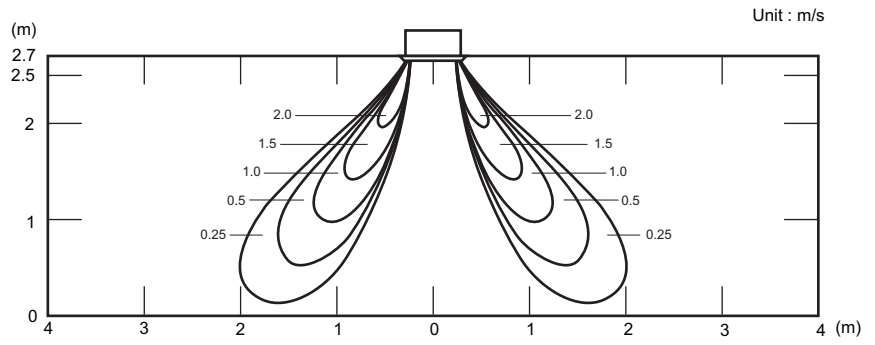

• Air temperature distribution

Measuring conditions	Fan speed	Operation mode	Outlet directions
NOTE:Reference data	HIGH	HEAT	4-way air outlet

Side view
Vertical airflow direction louver: down

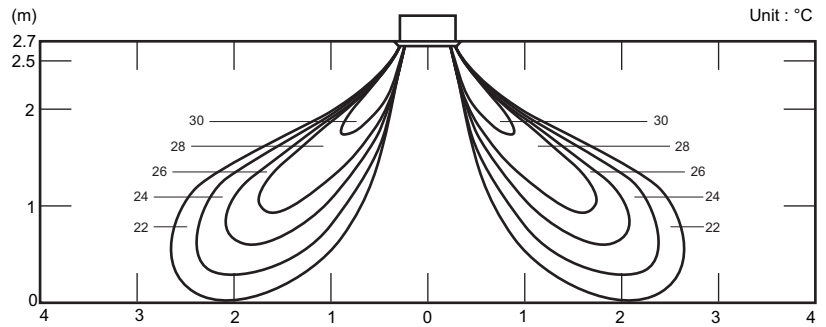

5-2. Mini duct type

Model: ARYG07LSLAP

NOTE: This data is measured after installing optional Auto louver grille kit.

- Air velocity distribution

Measuring conditions	Fan speed	Operation mode
	HIGH	FAN

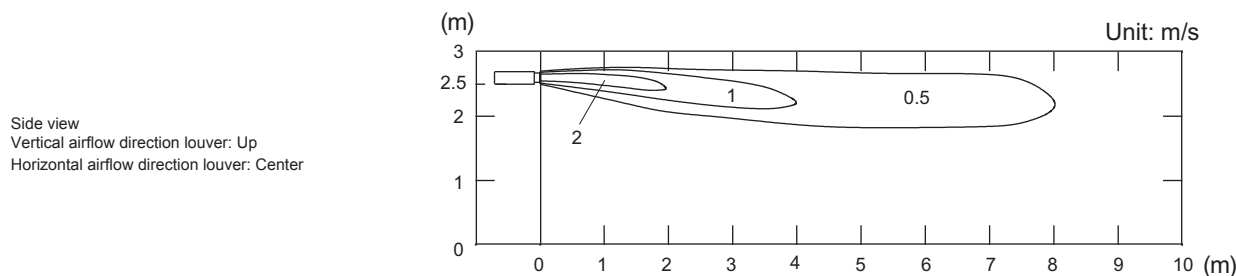
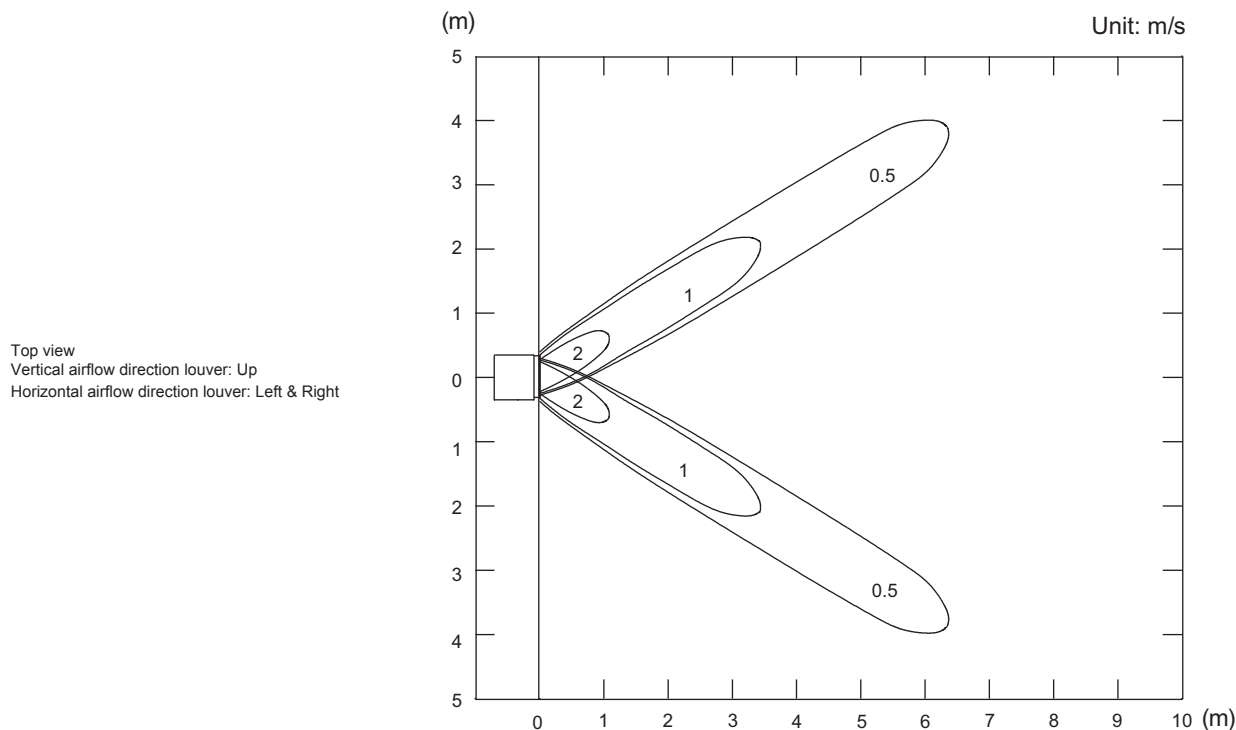
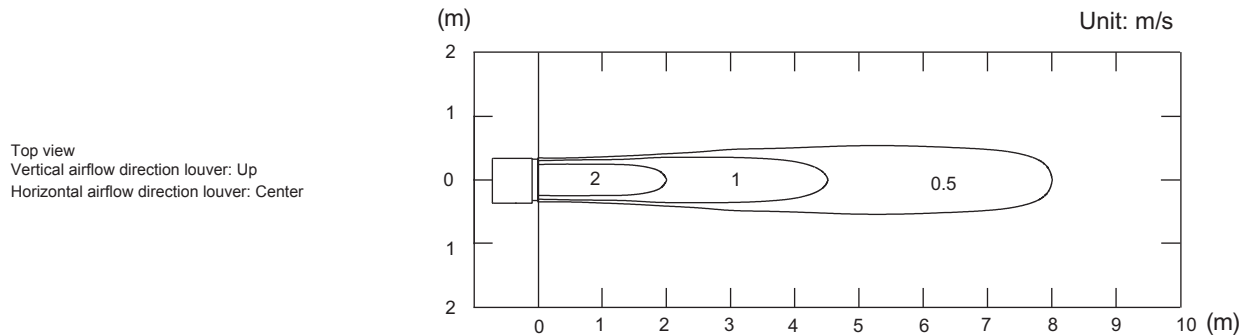

• Air velocity distribution

Measuring conditions	Fan speed	Operation mode
	HIGH	HEAT

Side view
Vertical airflow direction louver: Down
Horizontal airflow direction louver: Center

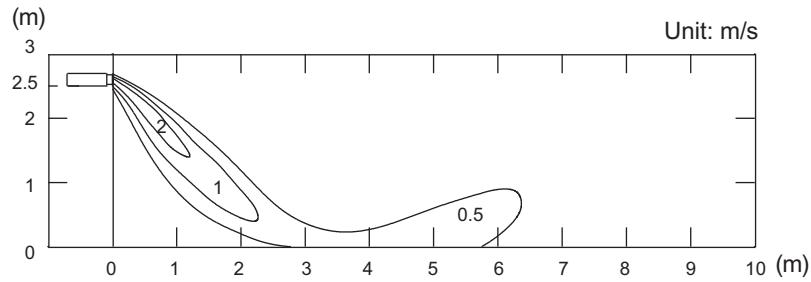

• Air temperature distribution

Measuring conditions	Fan speed	Operation mode
	HIGH	HEAT

Side view
Vertical airflow direction louver: Down
Horizontal airflow direction louver: Center

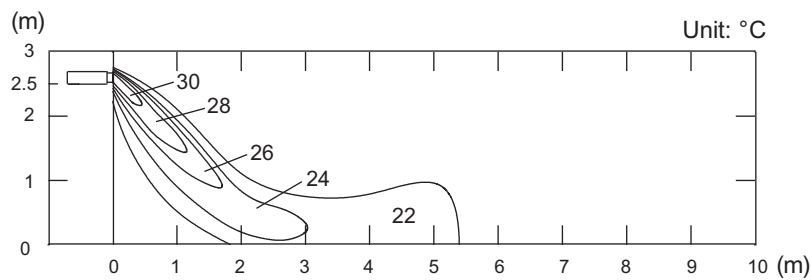

Model: ARYG09LSLAP

NOTE: This data is measured after installing optional Auto louver grille kit.

- Air velocity distribution

Measuring conditions	Fan speed	Operation mode
	HIGH	FAN

Top view
Vertical airflow direction louver: Up
Horizontal airflow direction louver: Center

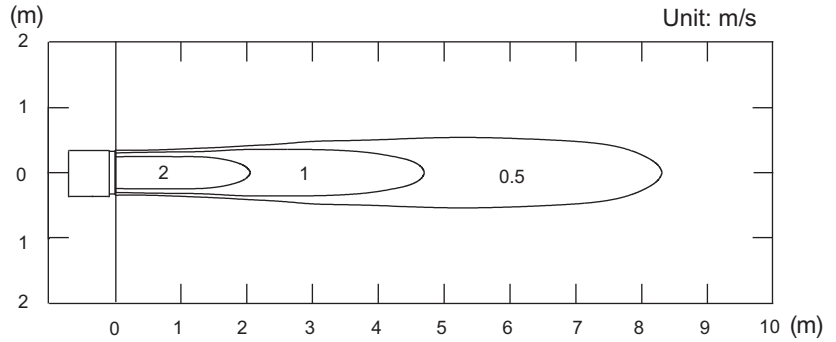

Top view
Vertical airflow direction louver: Up
Horizontal airflow direction louver: Left & Right

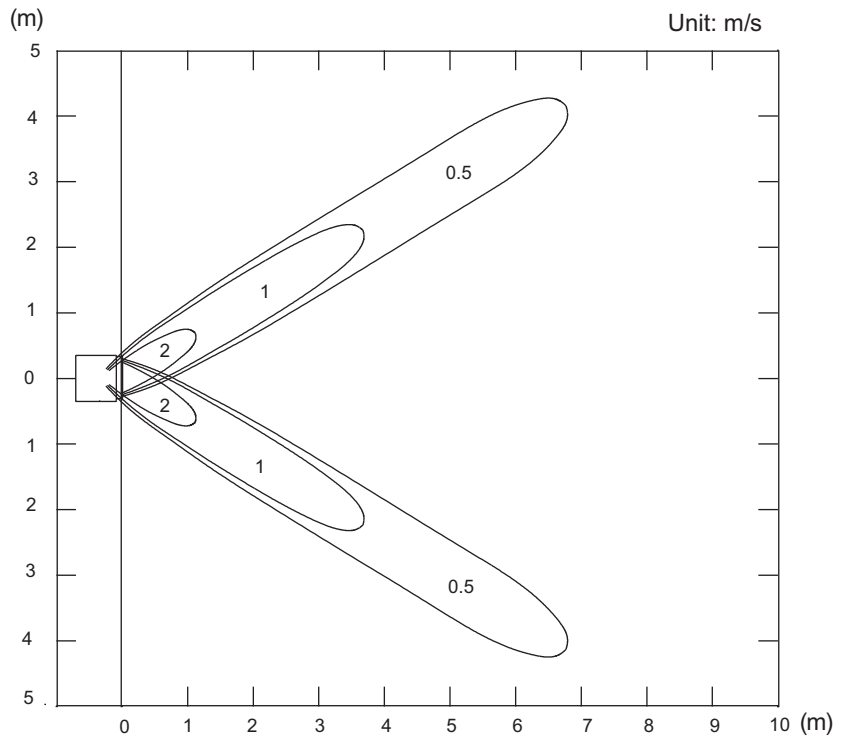

Side view
Vertical airflow direction louver: Up
Horizontal airflow direction louver: Center

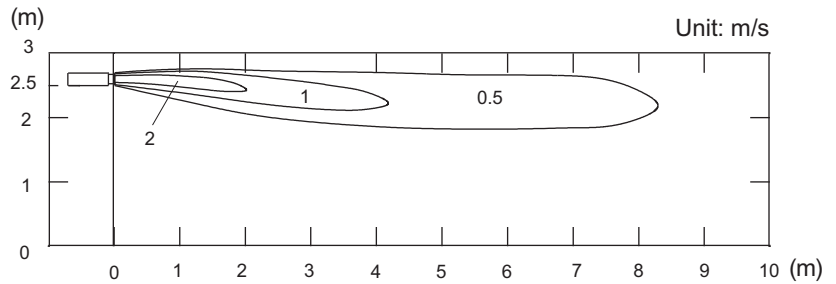

• Air velocity distribution

Measuring conditions	Fan speed	Operation mode
	HIGH	HEAT

Side view
Vertical airflow direction louver: Down
Horizontal airflow direction louver: Center

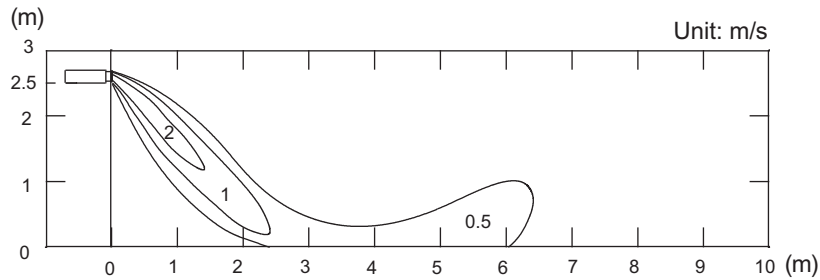

• Air temperature distribution

Measuring conditions	Fan speed	Operation mode
	HIGH	HEAT

Side view
Vertical airflow direction louver: Down
Horizontal airflow direction louver: Center

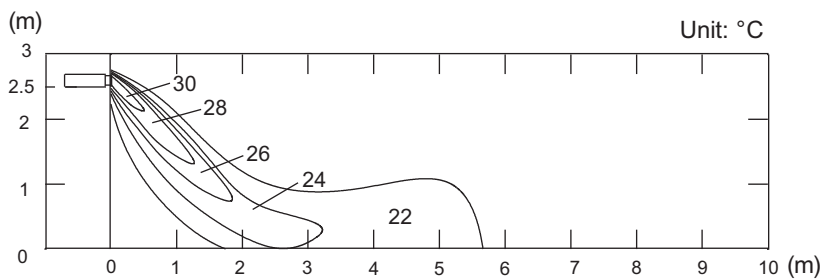

Model: ARYG12LSLAP

NOTE: This data is measured after installing optional Auto louver grille kit.

- Air velocity distribution

Measuring conditions	Fan speed	Operation mode
	HIGH	FAN

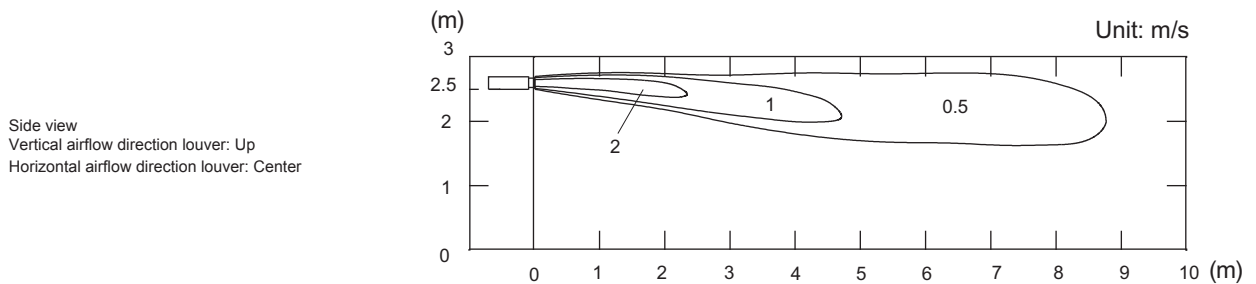
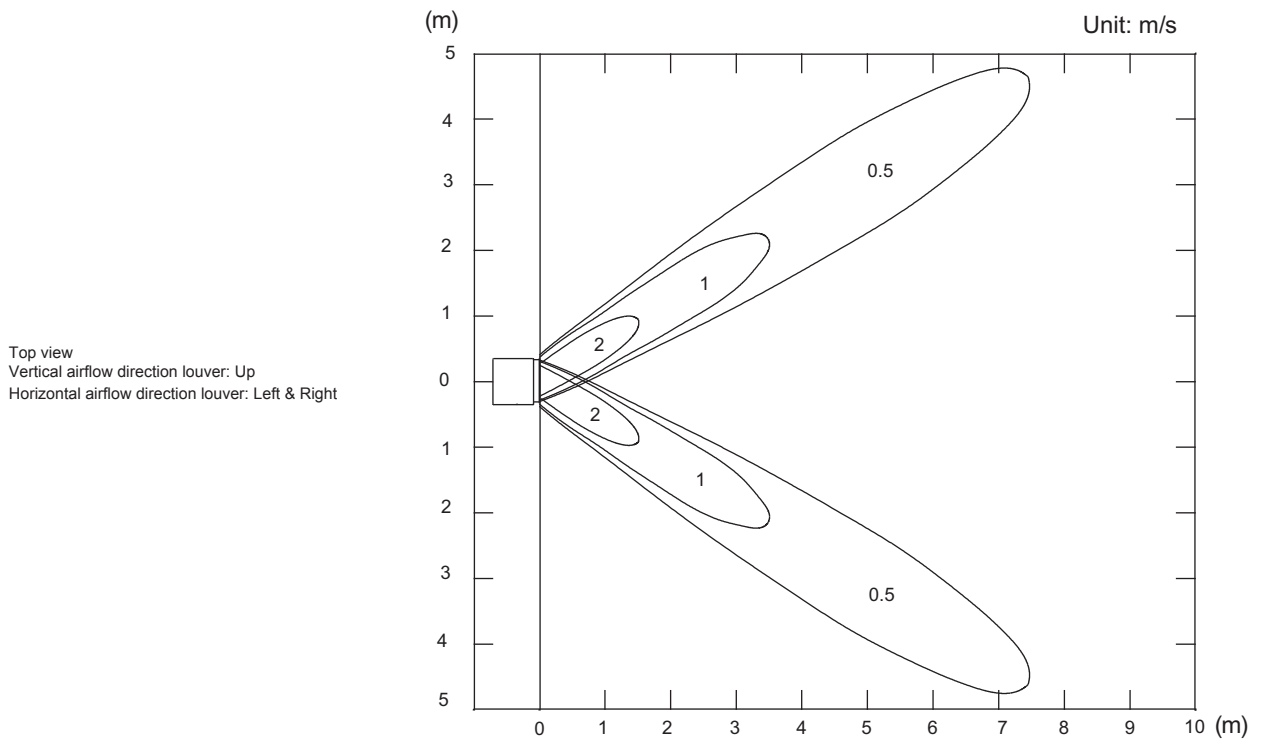
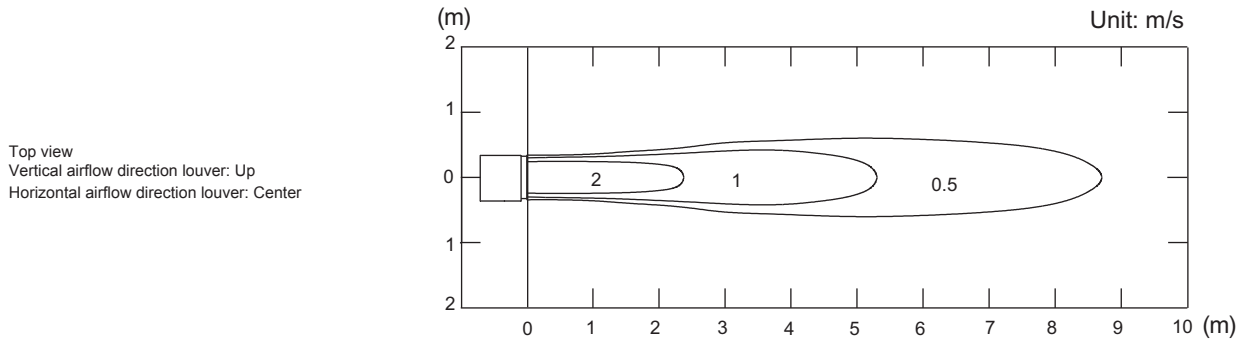

• Air velocity distribution

Measuring conditions	Fan speed	Operation mode
	HIGH	HEAT

Side view
Vertical airflow direction louver: Down
Horizontal airflow direction louver: Center

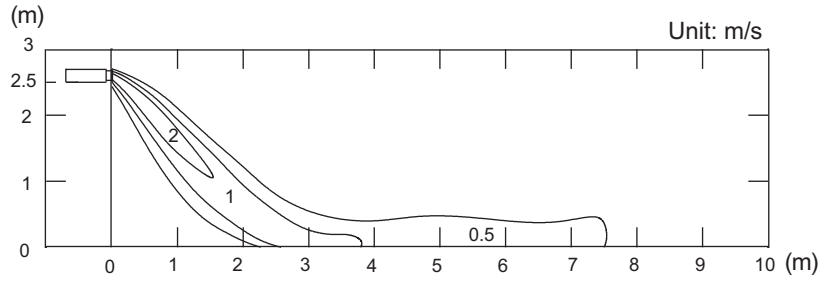

• Air temperature distribution

Measuring conditions	Fan speed	Operation mode
	HIGH	HEAT

Side view
Vertical airflow direction louver: Down
Horizontal airflow direction louver: Center

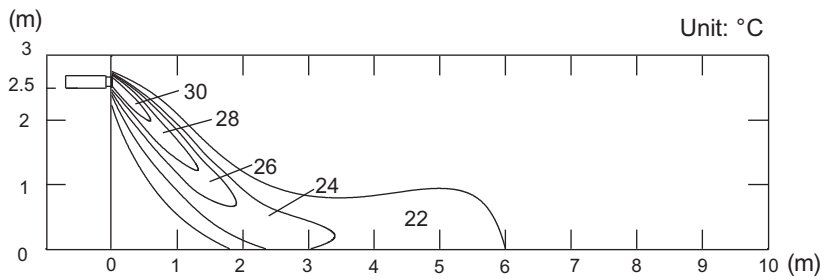

Model: ARYG14LSLAP

NOTE: This data is measured after installing optional Auto louver grille kit.

- Air velocity distribution

Measuring conditions	Fan speed	Operation mode
	HIGH	FAN

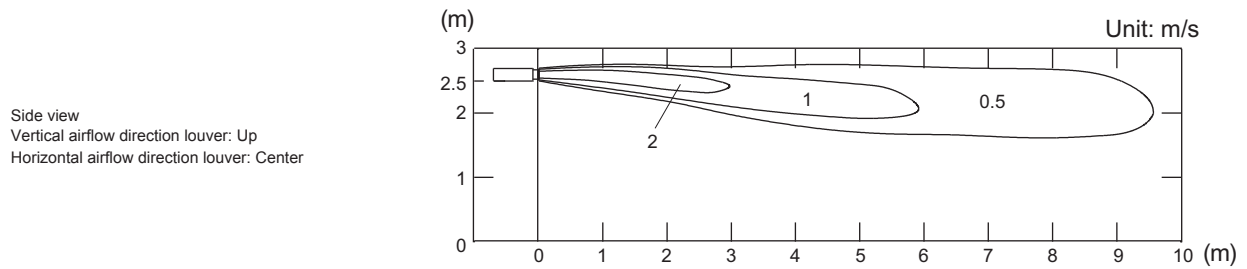
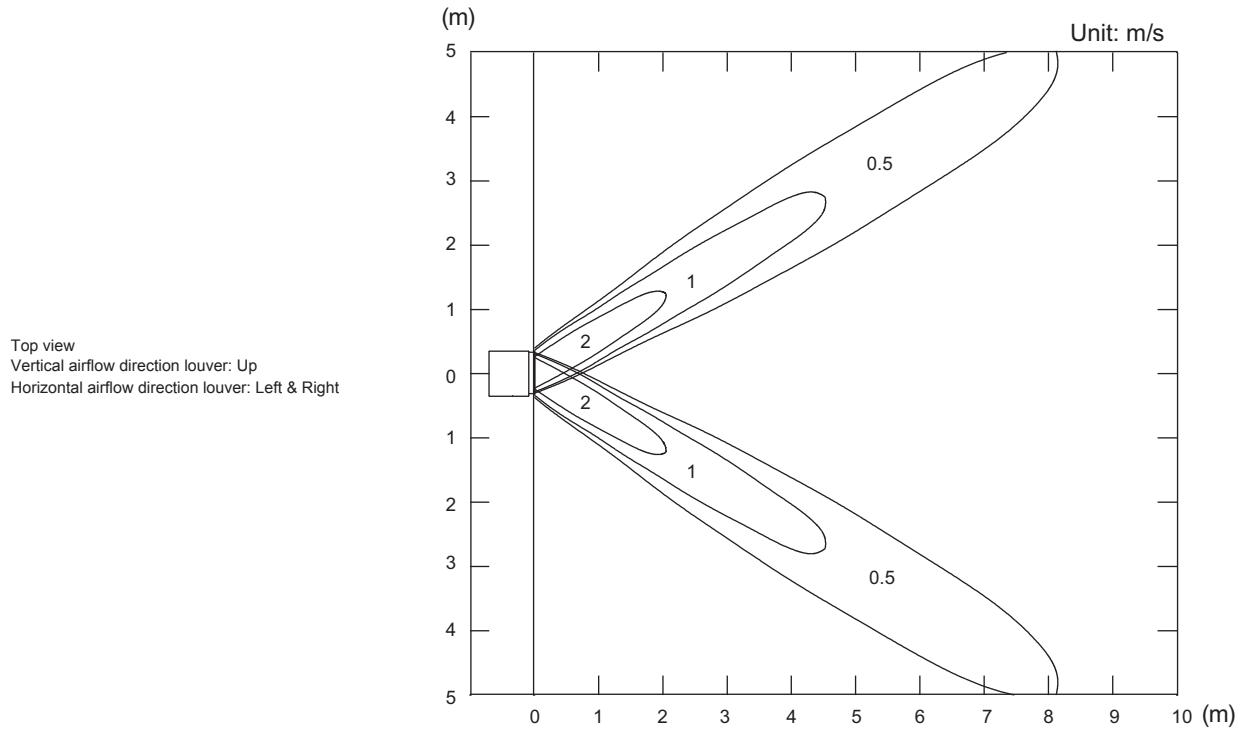
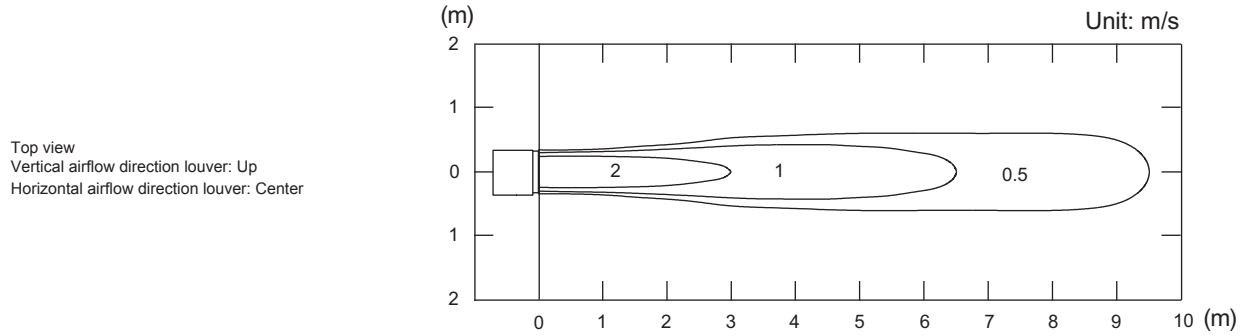

• Air velocity distribution

Measuring conditions	Fan speed	Operation mode
	HIGH	HEAT

Side view
Vertical airflow direction louver: Down
Horizontal airflow direction louver: Center

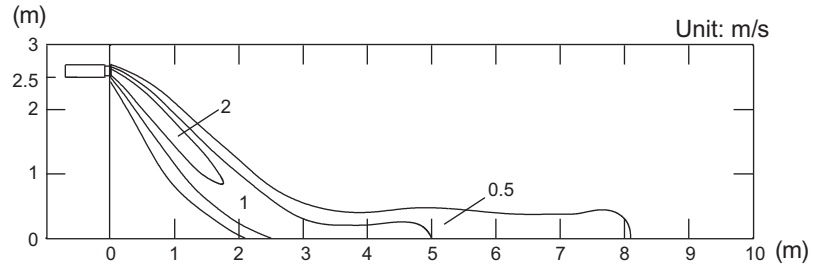

• Air temperature distribution

Measuring conditions	Fan speed	Operation mode
	HIGH	HEAT

Side view
Vertical airflow direction louver: Down
Horizontal airflow direction louver: Center

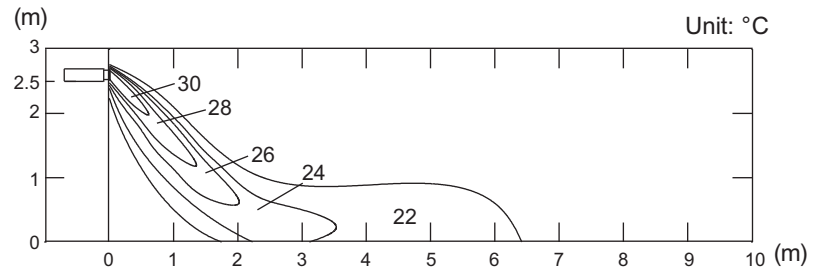

Model: ARYG18LSLAP

NOTE: This data is measured after installing optional Auto louver grille kit.

- Air velocity distribution

Measuring conditions	Fan speed	Operation mode
	HIGH	FAN

Top view
Vertical airflow direction louver: Up
Horizontal airflow direction louver: Center

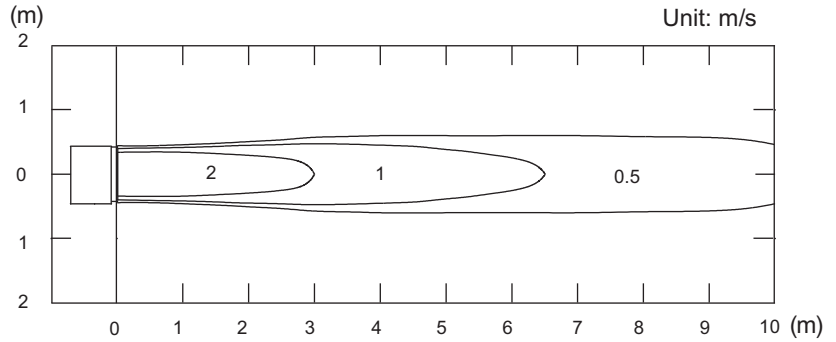

Top view
Vertical airflow direction louver: Up
Horizontal airflow direction louver: Left & Right

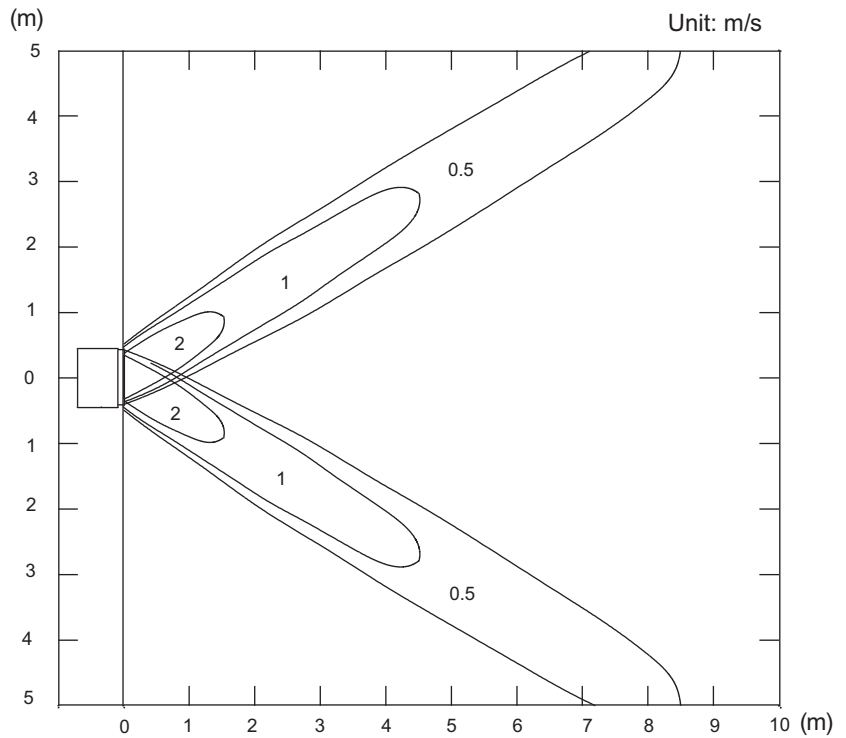

Side view
Vertical airflow direction louver: Up
Horizontal airflow direction louver: Center

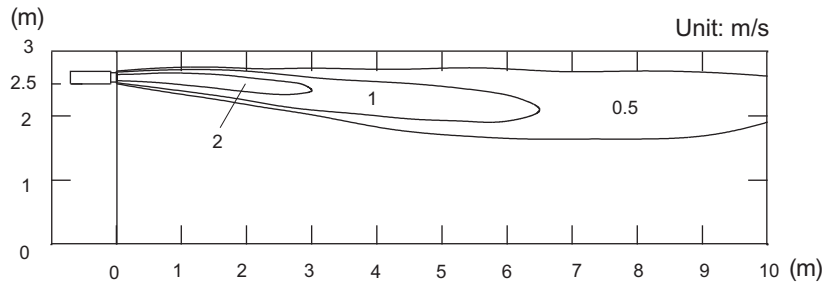

• Air velocity distribution

Measuring conditions	Fan speed	Operation mode
	HIGH	HEAT

Side view
Vertical airflow direction louver: Down
Horizontal airflow direction louver: Center

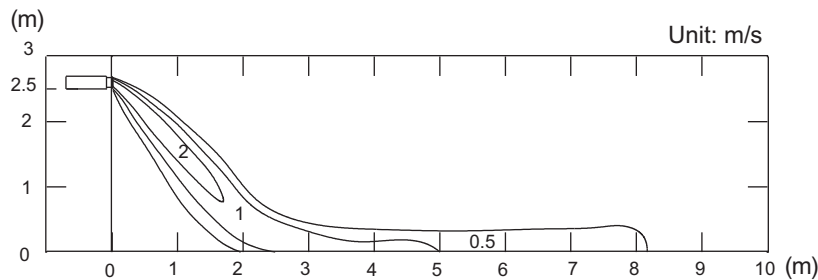

• Air temperature distribution

Measuring conditions	Fan speed	Operation mode
	HIGH	HEAT

Side view
Vertical airflow direction louver: Down
Horizontal airflow direction louver: Center

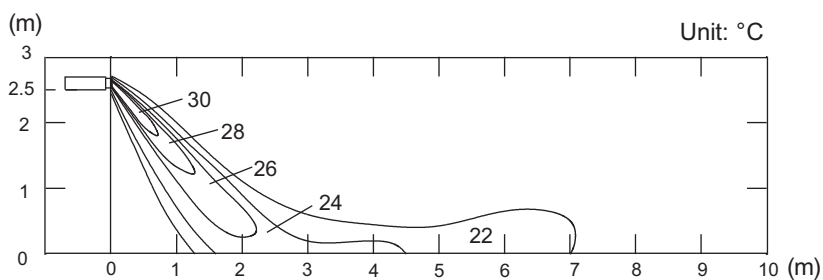

5-3. Slim duct type

Model: ARYG07LLTA

NOTE: This data is measured after installing optional Auto louver grille kit.

- Air velocity distribution

Measuring conditions	Fan speed	Operation mode
	HIGH	FAN

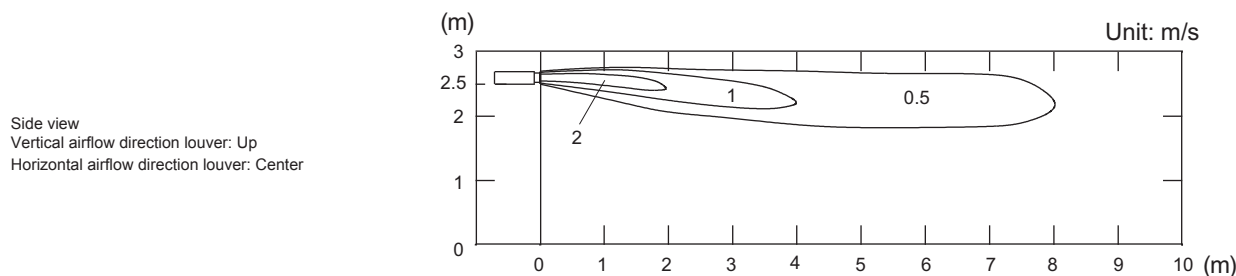
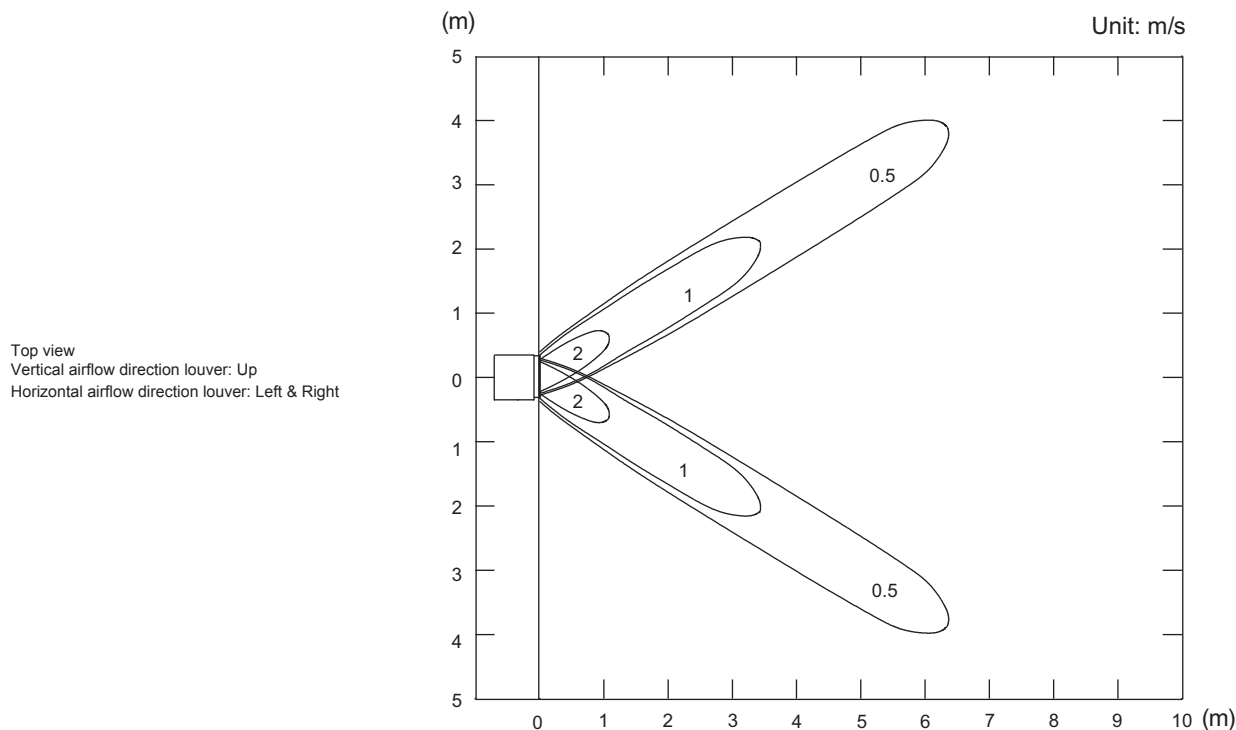
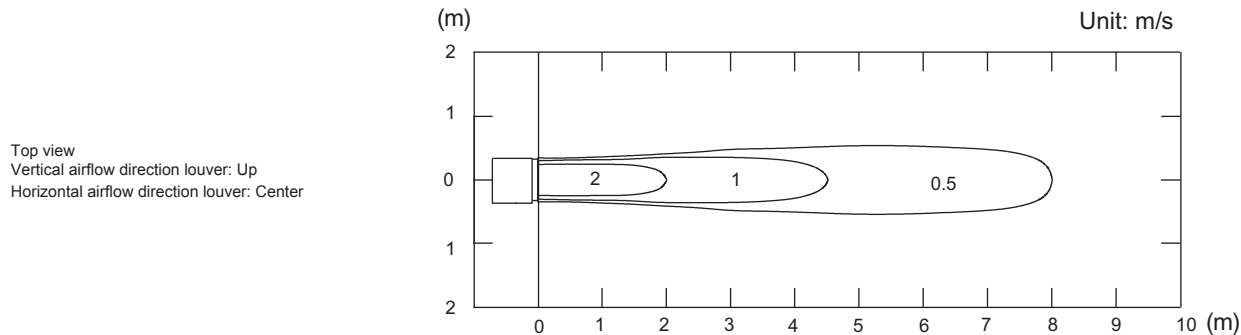

• Air velocity distribution

Measuring conditions	Fan speed	Operation mode
	HIGH	HEAT

Side view
Vertical airflow direction louver: Down
Horizontal airflow direction louver: Center

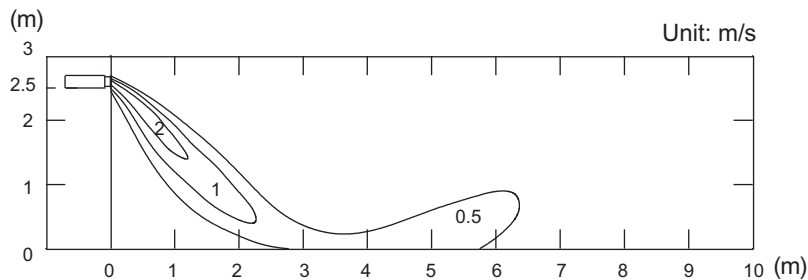

• Air temperature distribution

Measuring conditions	Fan speed	Operation mode
	HIGH	HEAT

Side view
Vertical airflow direction louver: Down
Horizontal airflow direction louver: Center

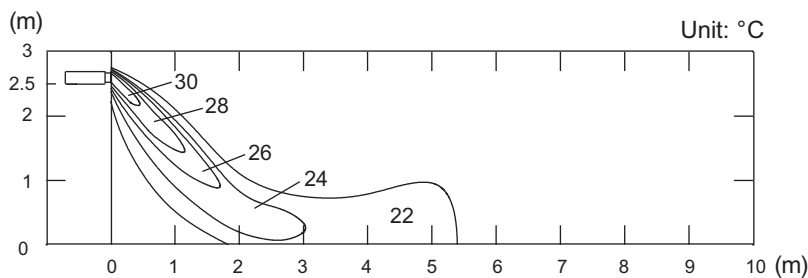

Model: ARYG09LLTA

NOTE: This data is measured after installing optional Auto louver grille kit.

- Air velocity distribution

Measuring conditions	Fan speed	Operation mode
	HIGH	FAN

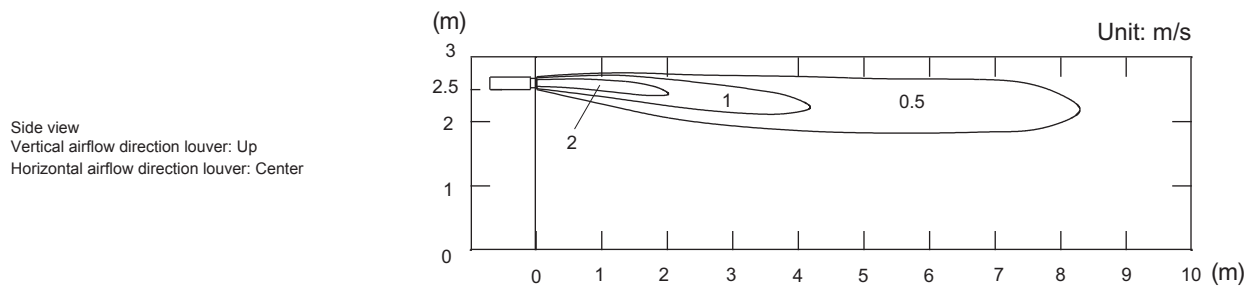
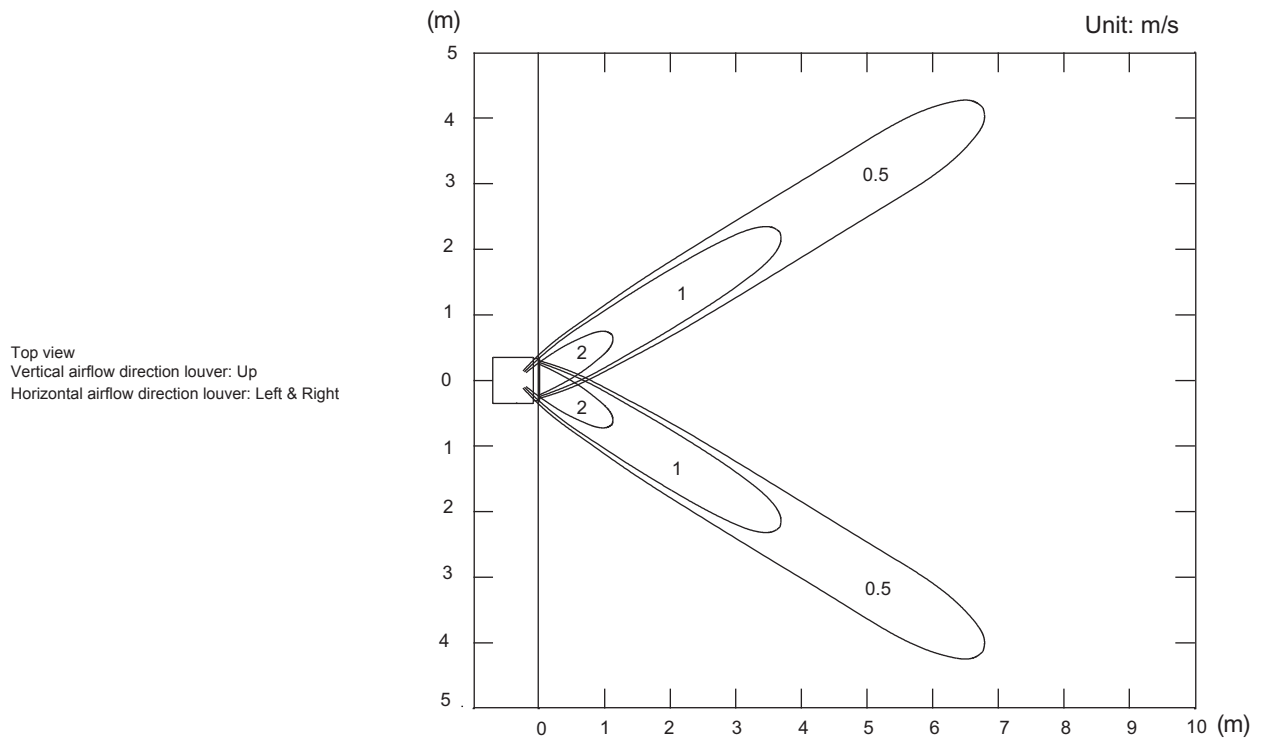
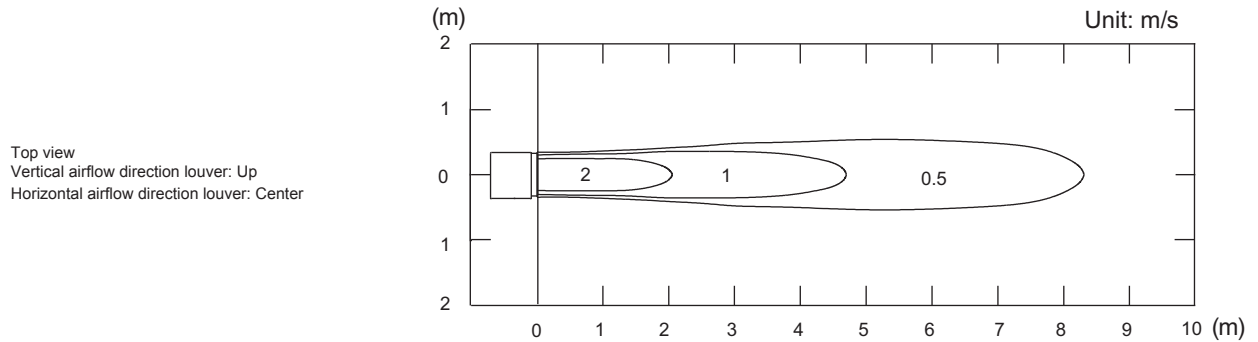

• Air velocity distribution

Measuring conditions	Fan speed	Operation mode
	HIGH	HEAT

Side view
Vertical airflow direction louver: Down
Horizontal airflow direction louver: Center

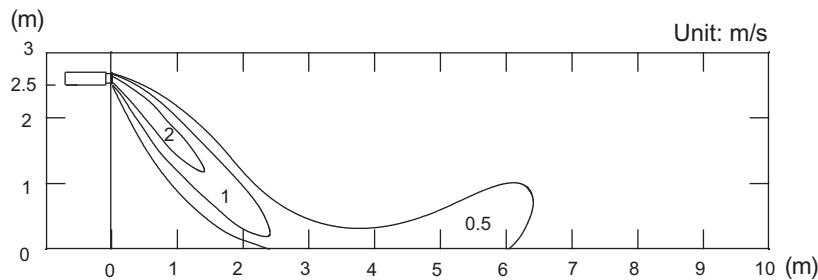

• Air temperature distribution

Measuring conditions	Fan speed	Operation mode
	HIGH	HEAT

Side view
Vertical airflow direction louver: Down
Horizontal airflow direction louver: Center

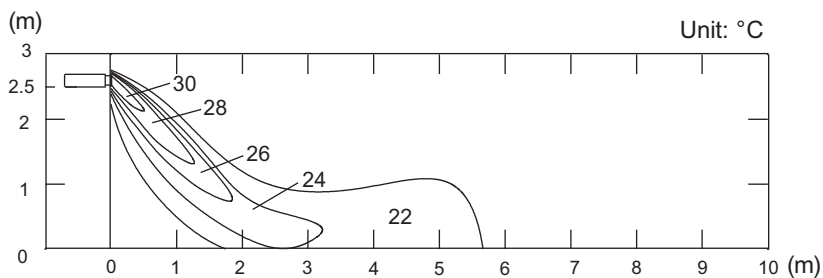

Model: ARYG12LLTB

NOTE: This data is measured after installing optional Auto louver grille kit.

- Air velocity distribution

Measuring conditions	Fan speed	Operation mode
	HIGH	FAN

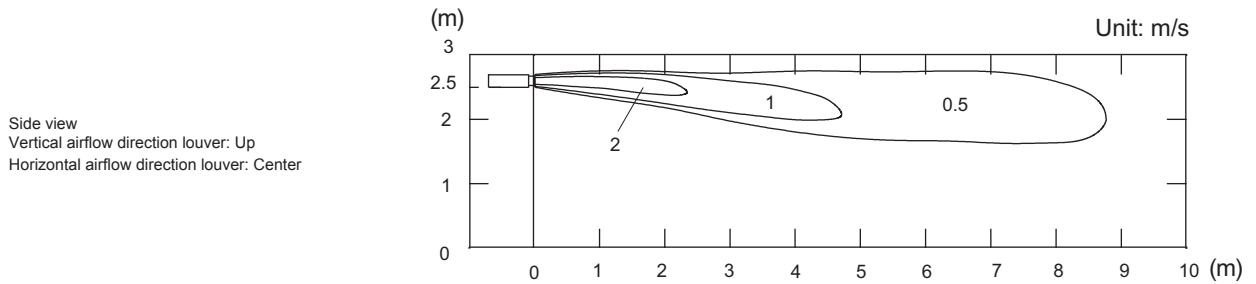
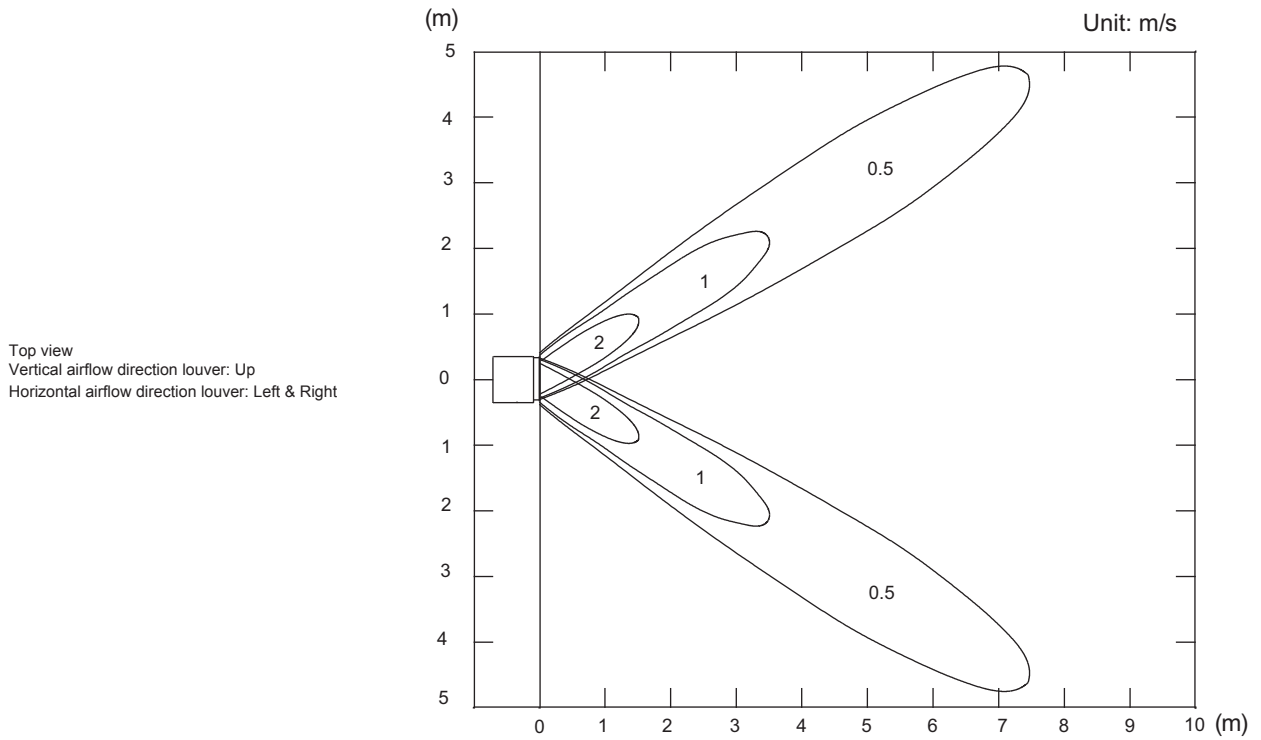
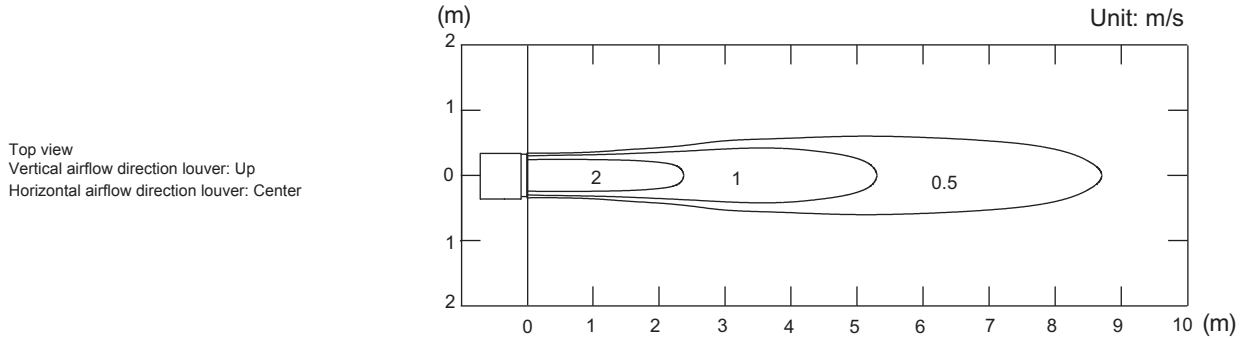

• Air velocity distribution

Measuring conditions	Fan speed	Operation mode
	HIGH	HEAT

Side view
Vertical airflow direction louver: Down
Horizontal airflow direction louver: Center

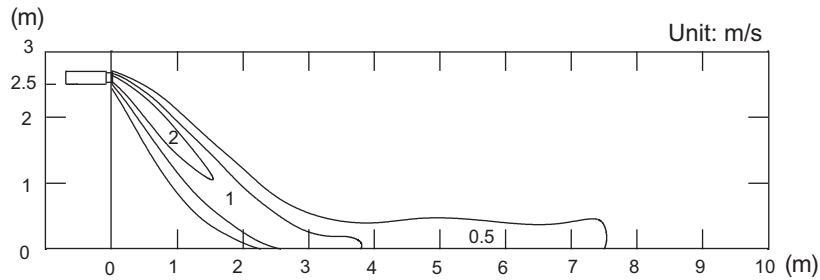

• Air temperature distribution

Measuring conditions	Fan speed	Operation mode
	HIGH	HEAT

Side view
Vertical airflow direction louver: Down
Horizontal airflow direction louver: Center

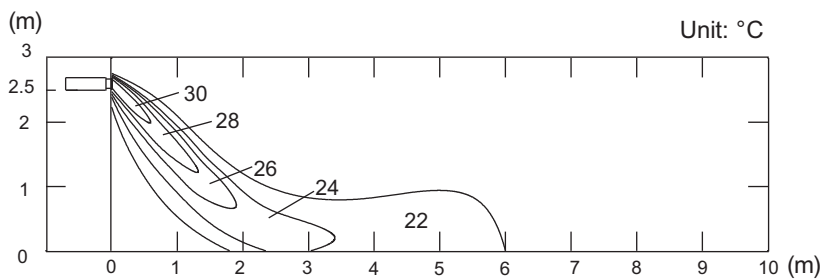

Model: ARYG14LLTB

NOTE: This data is measured after installing optional Auto louver grille kit.

- Air velocity distribution

Measuring conditions	Fan speed	Operation mode
	HIGH	FAN

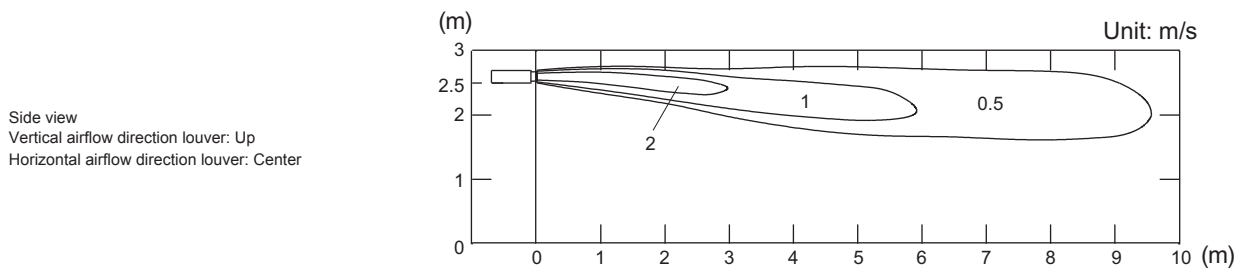
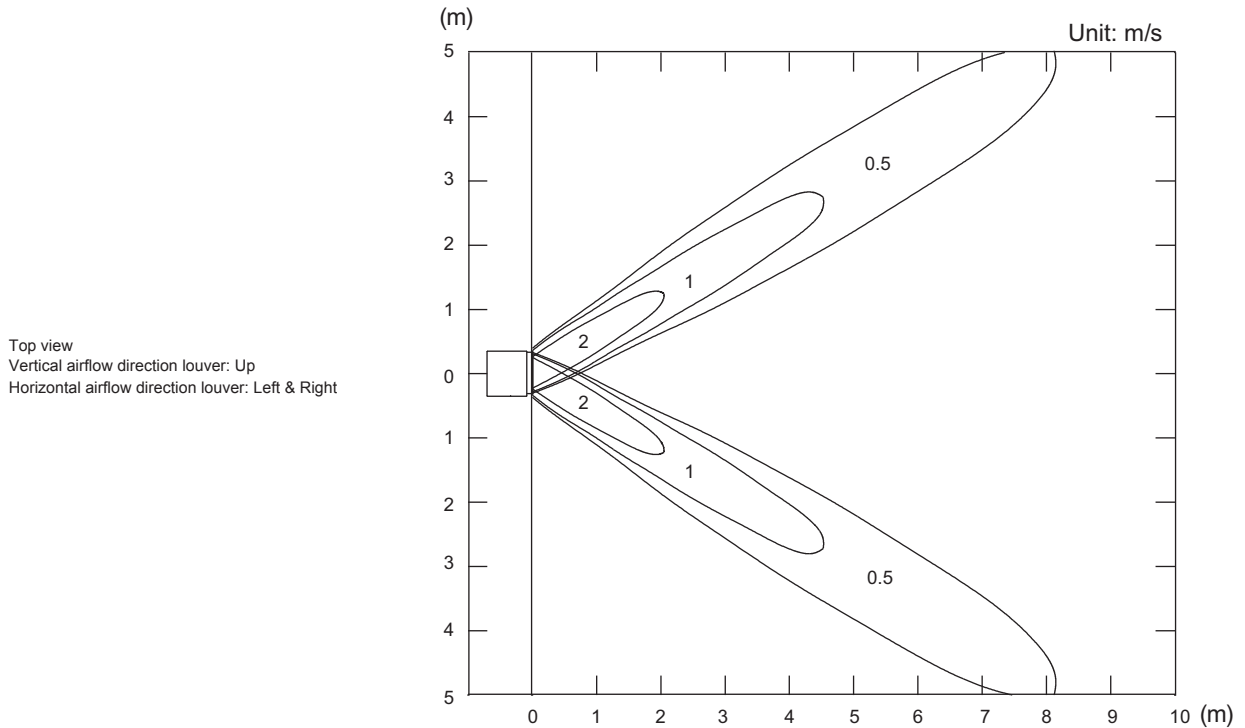
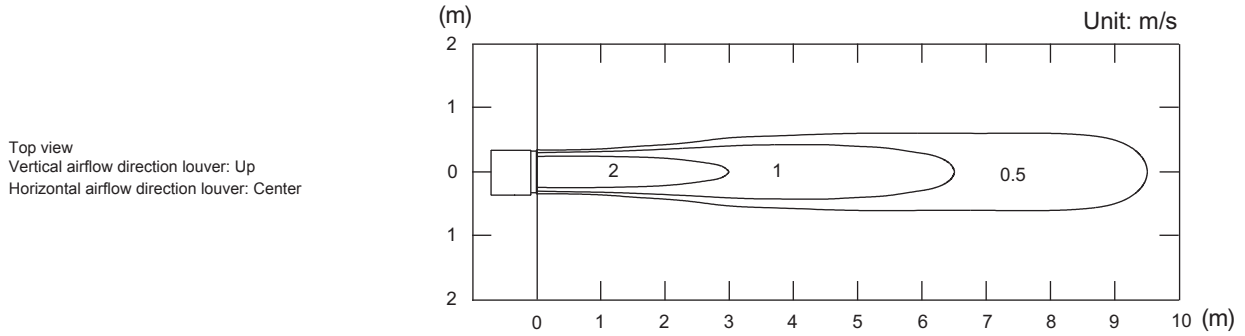

• Air velocity distribution

Measuring conditions	Fan speed	Operation mode
	HIGH	HEAT

Side view
Vertical airflow direction louver: Down
Horizontal airflow direction louver: Center

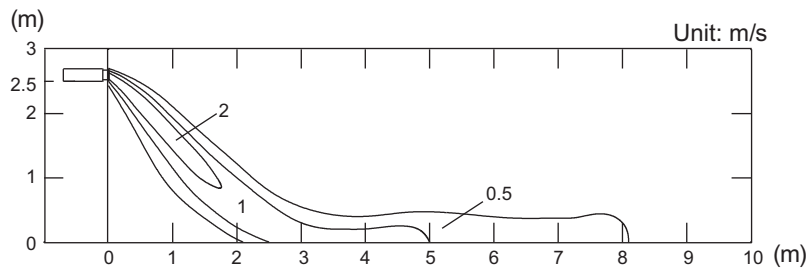

• Air temperature distribution

Measuring conditions	Fan speed	Operation mode
	HIGH	HEAT

Side view
Vertical airflow direction louver: Down
Horizontal airflow direction louver: Center

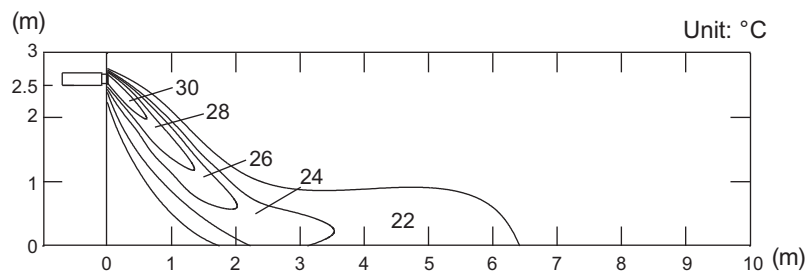

Model: ARYG18LLTB

NOTE: This data is measured after installing optional Auto louver grille kit.

- Air velocity distribution

Measuring conditions	Fan speed	Operation mode
	HIGH	FAN

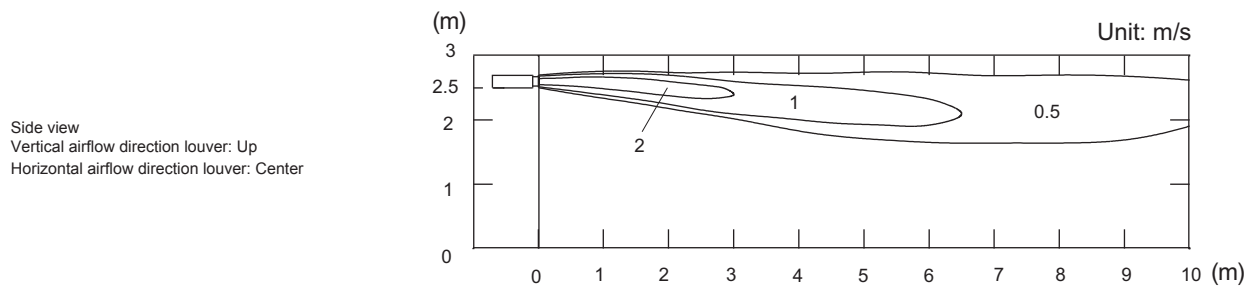
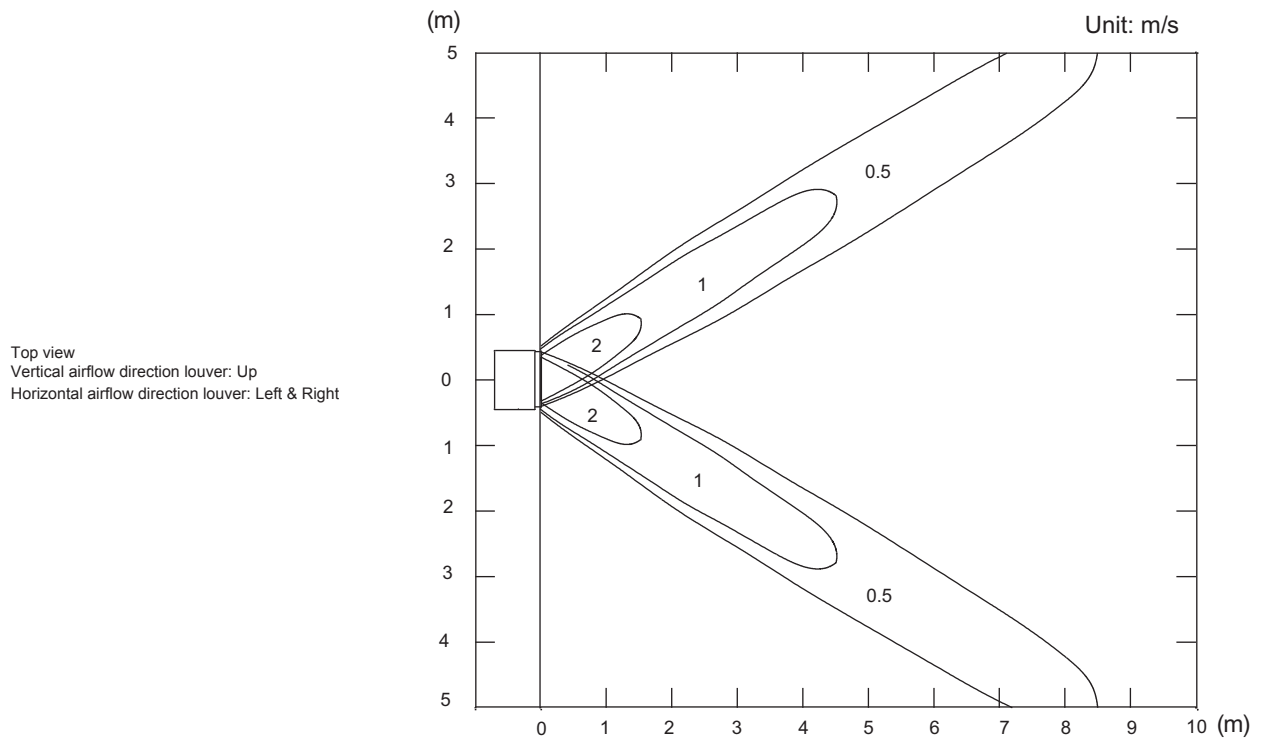
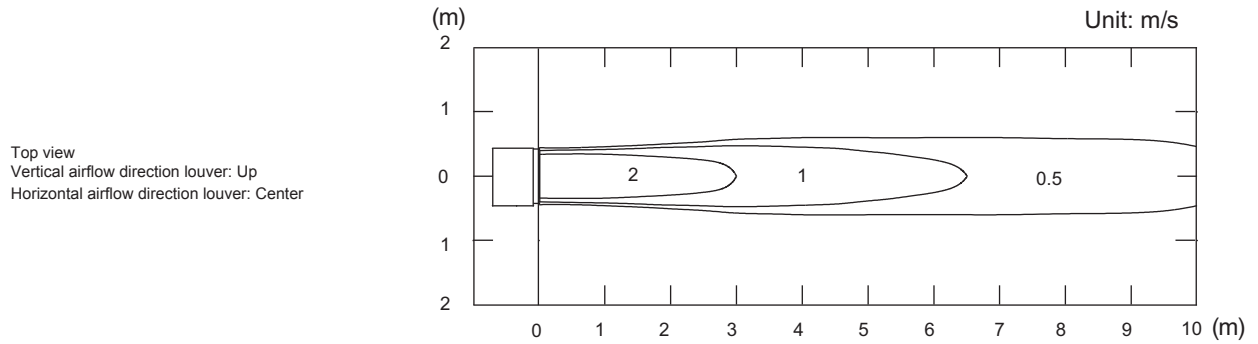

• Air velocity distribution

Measuring conditions	Fan speed	Operation mode
	HIGH	HEAT

Side view
Vertical airflow direction louver: Down
Horizontal airflow direction louver: Center

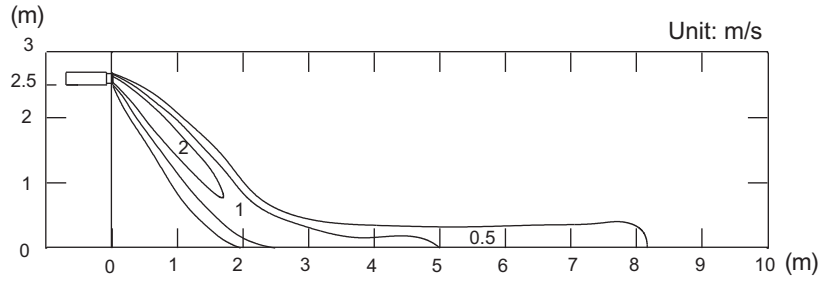

• Air temperature distribution

Measuring conditions	Fan speed	Operation mode
	HIGH	HEAT

Side view
Vertical airflow direction louver: Down
Horizontal airflow direction louver: Center

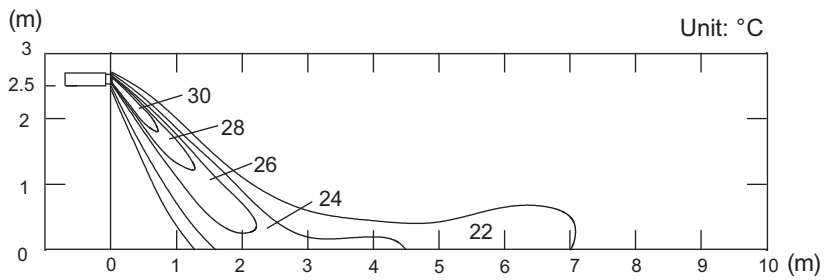

5-4. Wall mounted type

Models: ASYG07LUCA and ASYG09LUCA

Measuring conditions	Fan speed	Operation mode
	HIGH	FAN

Top view
Vertical airflow direction louver: Up
Horizontal airflow direction louver: Center

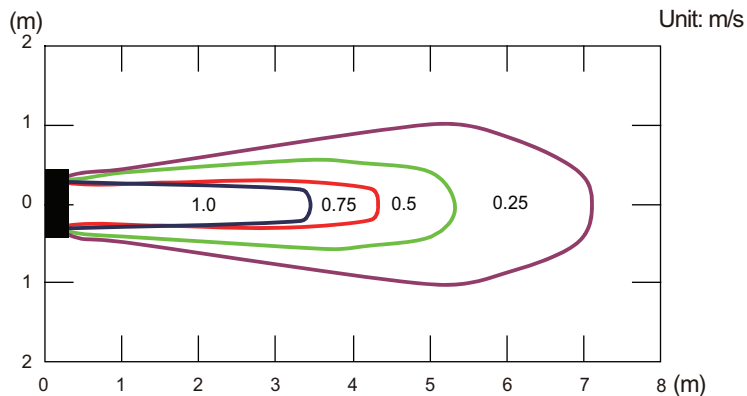

Top view
Vertical airflow direction louver: Up
Horizontal airflow direction louver: Left & Right

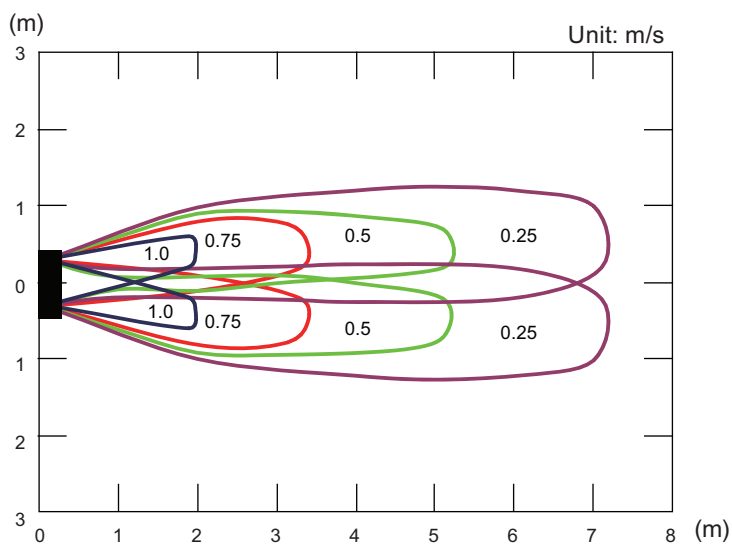

Side view
Vertical airflow direction louver: Up
Horizontal airflow direction louver: Center

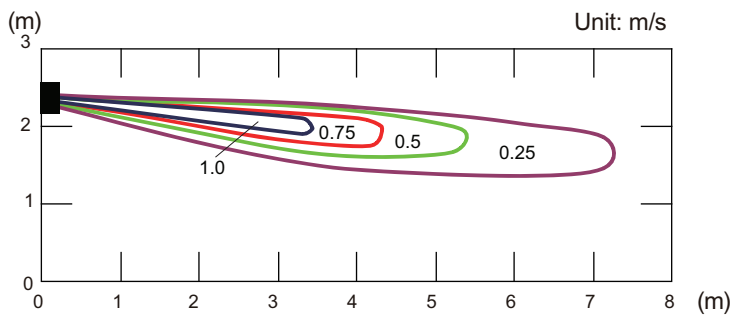

Side view
Vertical airflow direction louver: Down
Horizontal airflow direction louver: Center

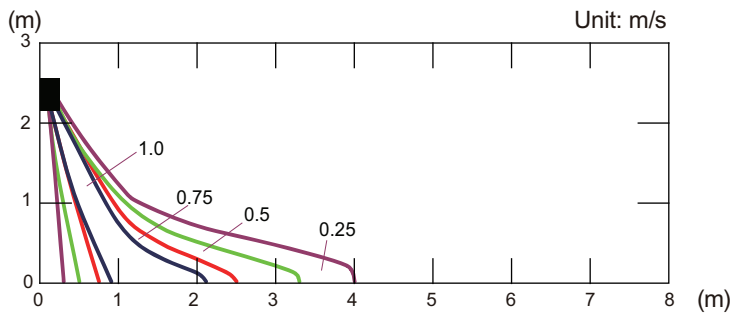

Models: ASYG12LUCA and ASYG14LUCA

MULTI TYPE
5, 6 ROOMS TYPE

MULTI TYPE
5, 6 ROOMS TYPE

Measuring conditions	Fan speed	Operation mode
	HIGH	FAN

Top view
Vertical airflow direction louver: Up
Horizontal airflow direction louver: Center

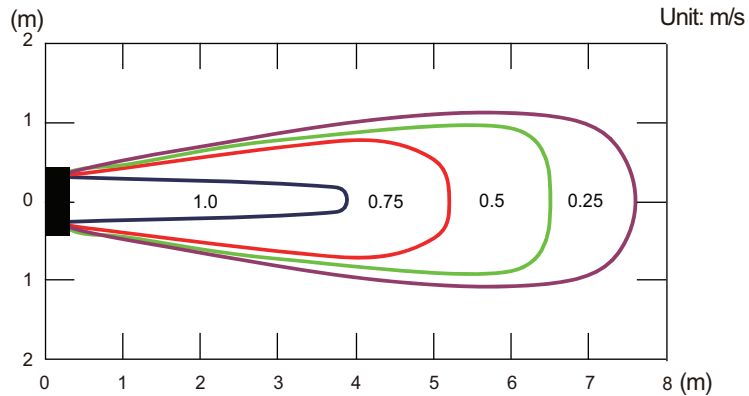

Top view
Vertical airflow direction louver: Up
Horizontal airflow direction louver: Left & Right

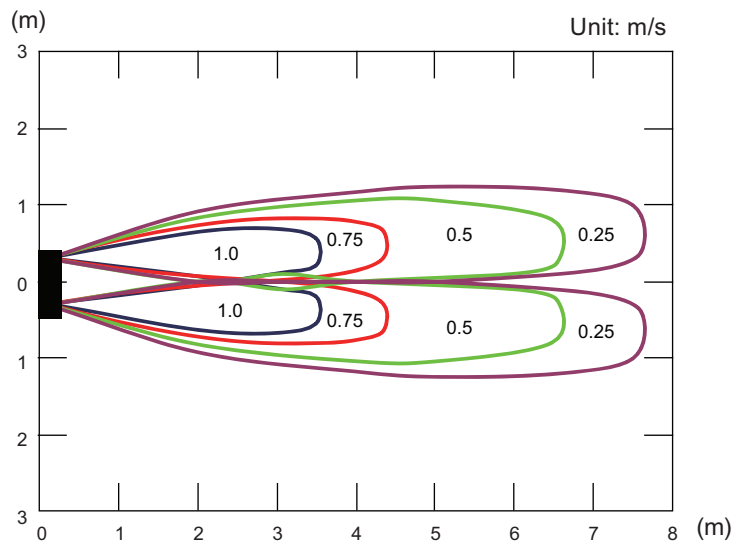

Side view
Vertical airflow direction louver: Up
Horizontal airflow direction louver: Center

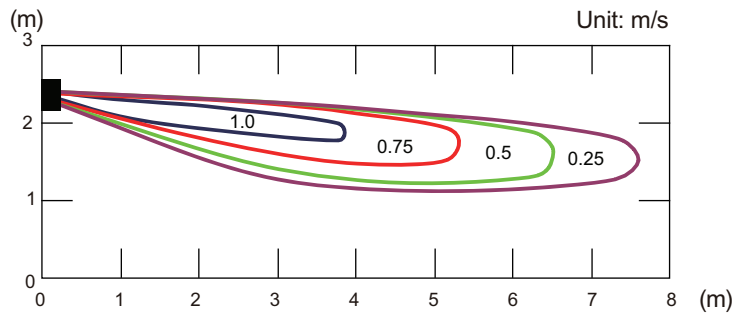

Side view
Vertical airflow direction louver: Down
Horizontal airflow direction louver: Center

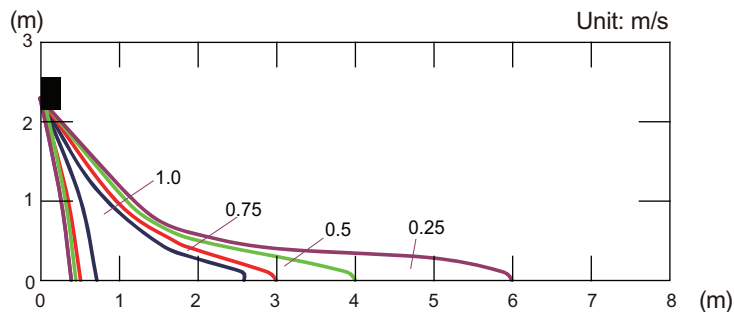

Models: ASYG07LMCA and ASYG07LMCE

MULTI TYPE
5, 6 ROOMS TYPE

MULTI TYPE
5, 6 ROOMS TYPE

Measuring conditions	Fan speed	Operation mode
	HIGH	FAN

Top view
Vertical airflow direction louver: Up
Horizontal airflow direction louver: Center

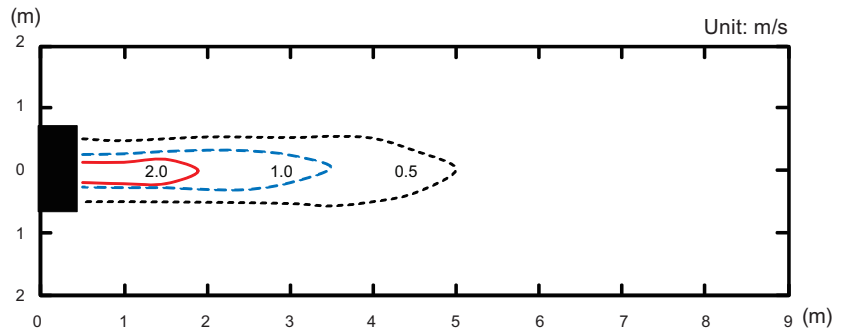

Top view
Vertical airflow direction louver: Up
Horizontal airflow direction louver: Left & Right

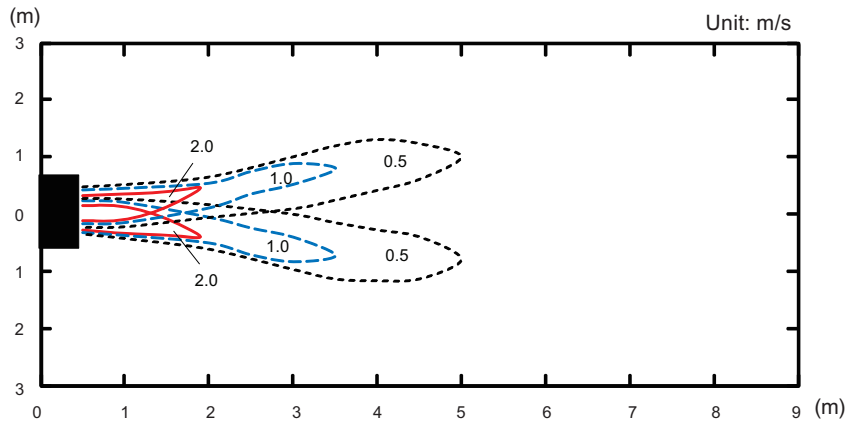

Side view
Vertical airflow direction louver: Up
Horizontal airflow direction louver: Center

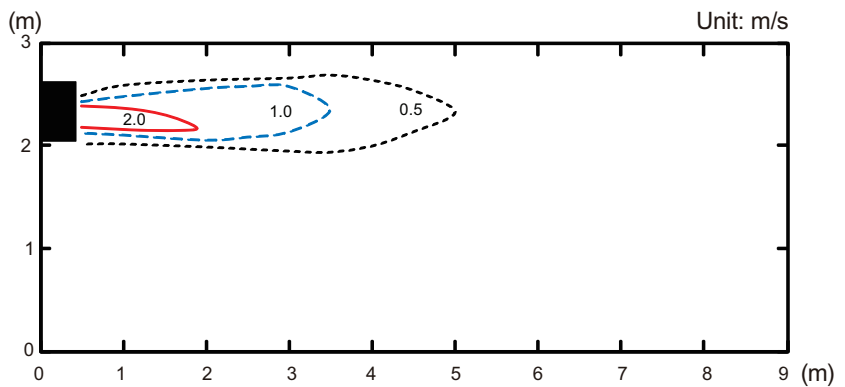

Side view
Vertical airflow direction louver: Down
Horizontal airflow direction louver: Center

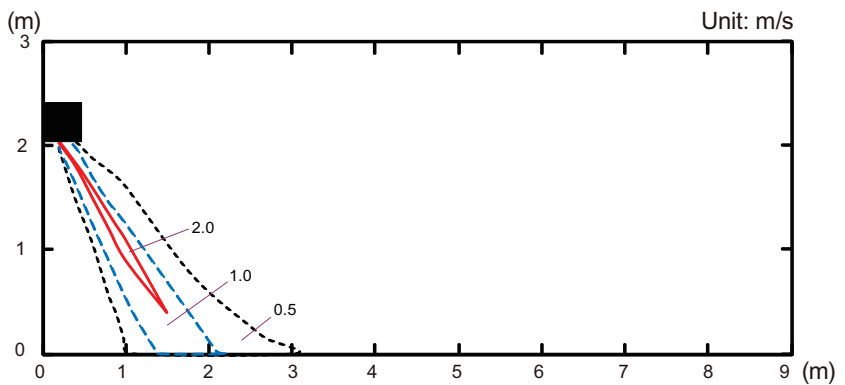

Models: ASYG09LMCA and ASYG09LMCE

MULTI TYPE
5, 6 ROOMS TYPE

MULTI TYPE
5, 6 ROOMS TYPE

Measuring conditions	Fan speed	Operation mode
	HIGH	FAN

Top view
Vertical airflow direction louver: Up
Horizontal airflow direction louver: Center

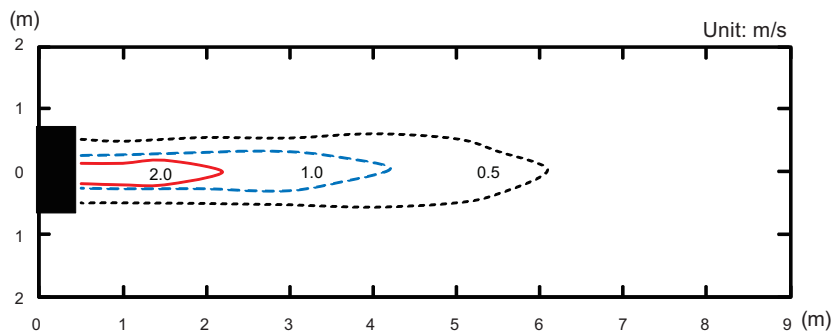

Top view
Vertical airflow direction louver: Up
Horizontal airflow direction louver: Left & Right

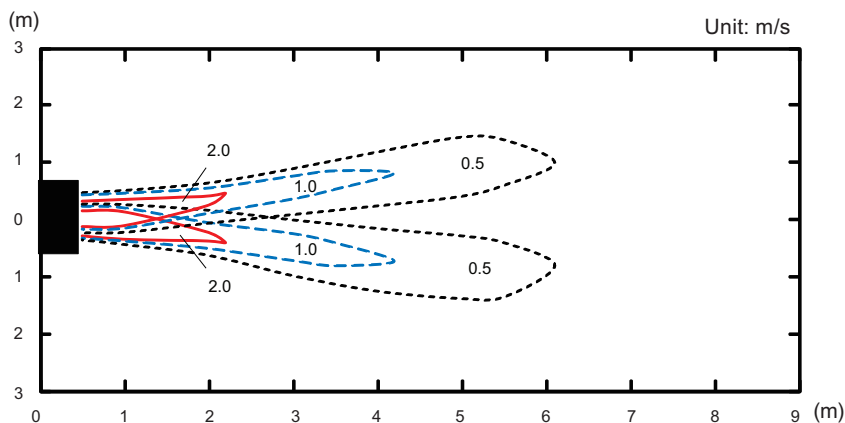

Side view
Vertical airflow direction louver: Up
Horizontal airflow direction louver: Center

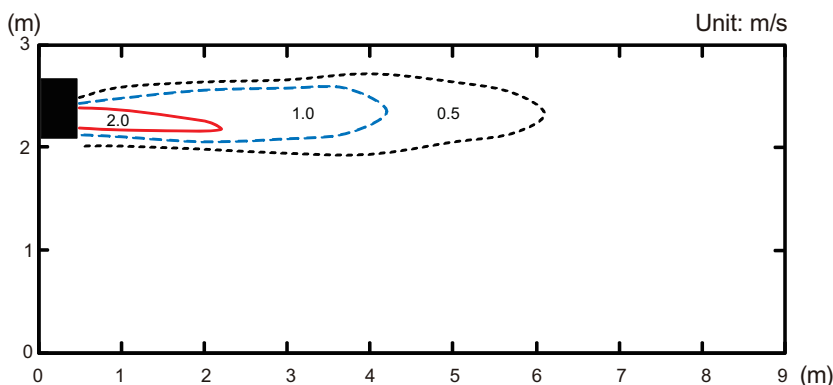

Side view
Vertical airflow direction louver: Down
Horizontal airflow direction louver: Center

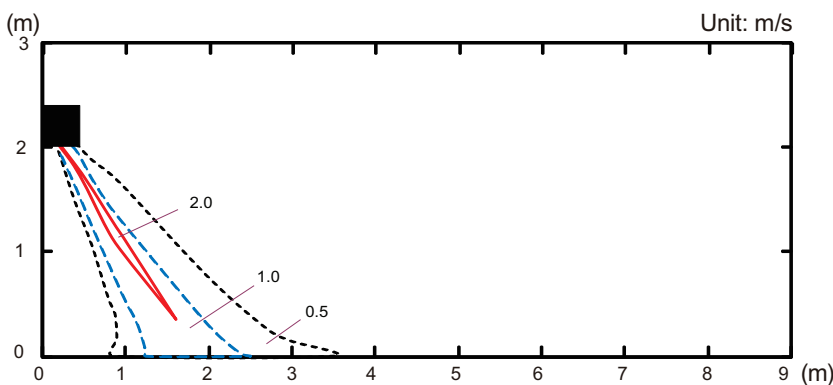

Models: ASYG12LMCA and ASYG12LMCE

MULTI TYPE
5, 6 ROOMS TYPE

MULTI TYPE
5, 6 ROOMS TYPE

Measuring conditions	Fan speed	Operation mode
	HIGH	FAN

Top view
Vertical airflow direction louver: Up
Horizontal airflow direction louver: Center

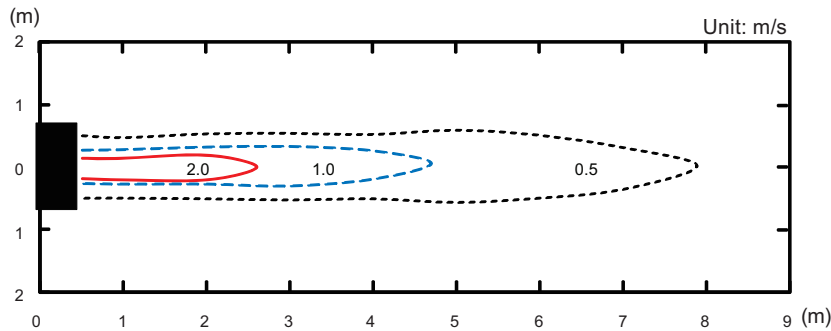

Top view
Vertical airflow direction louver: Up
Horizontal airflow direction louver: Left & Right

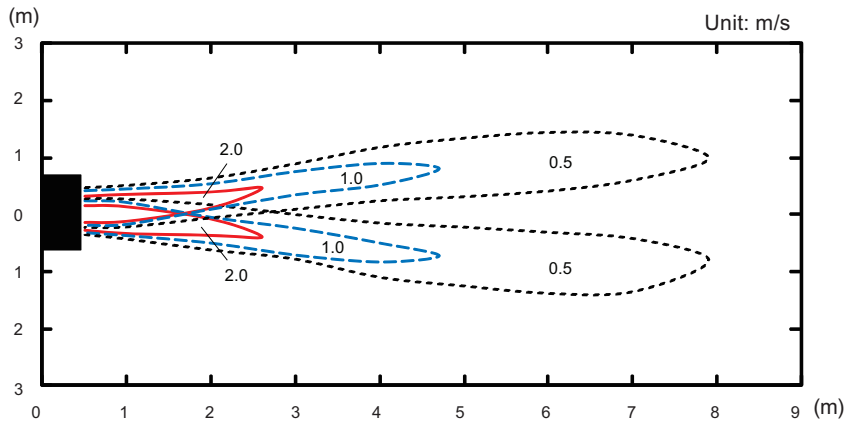

Side view
Vertical airflow direction louver: Up
Horizontal airflow direction louver: Center

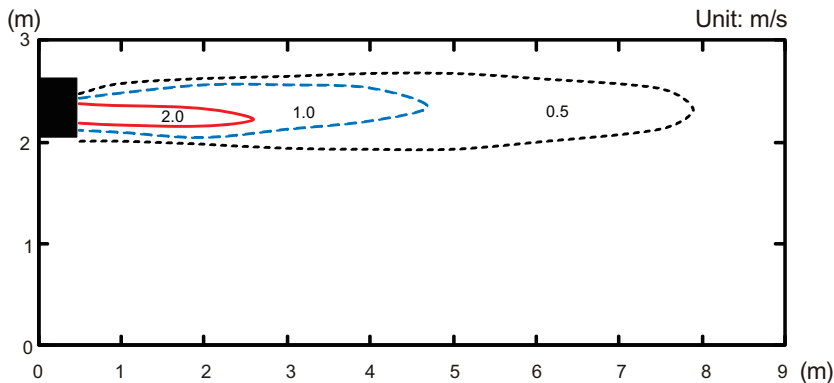

Side view
Vertical airflow direction louver: Down
Horizontal airflow direction louver: Center

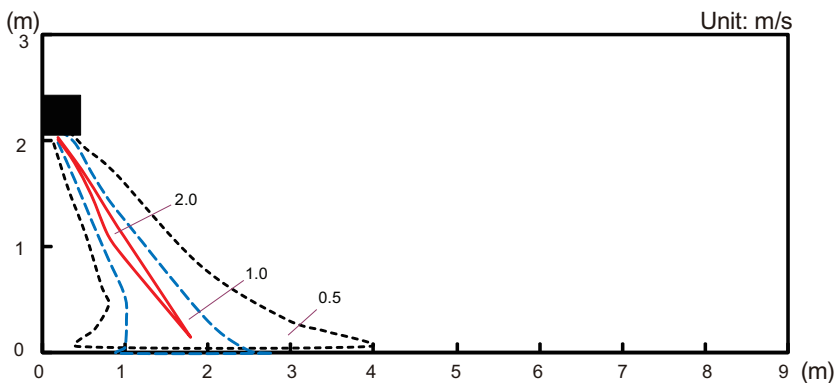

Models: ASYG14LMCA and ASYG14LMCE

MULTI TYPE
5, 6 ROOMS TYPE

MULTI TYPE
5, 6 ROOMS TYPE

Measuring conditions	Fan speed	Operation mode
	HIGH	FAN

Top view
Vertical airflow direction louver: Up
Horizontal airflow direction louver: Center

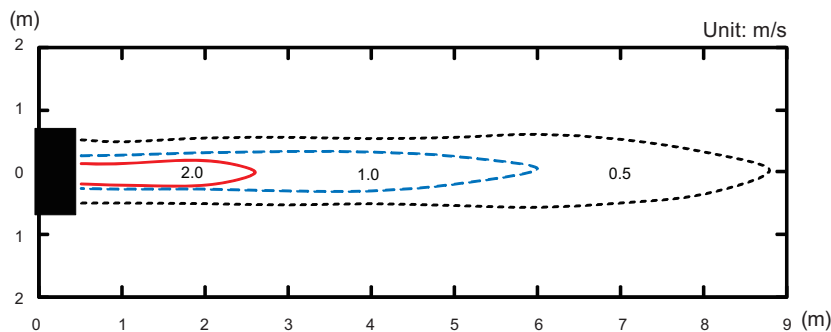

Top view
Vertical airflow direction louver: Up
Horizontal airflow direction louver: Left & Right

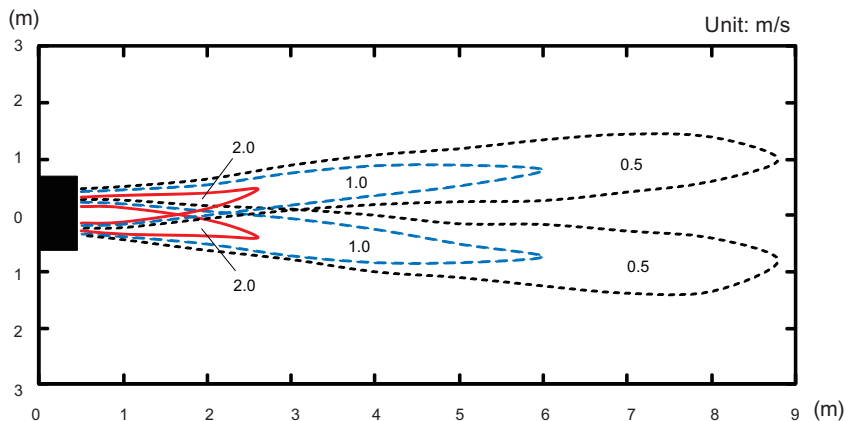

Side view
Vertical airflow direction louver: Up
Horizontal airflow direction louver: Center

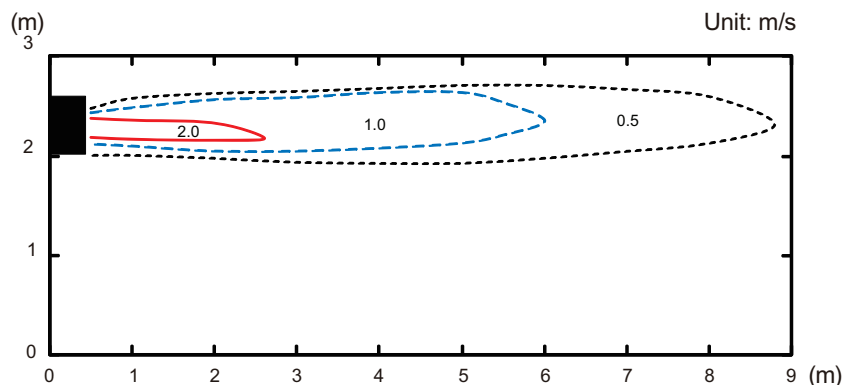

Side view
Vertical airflow direction louver: Down
Horizontal airflow direction louver: Center

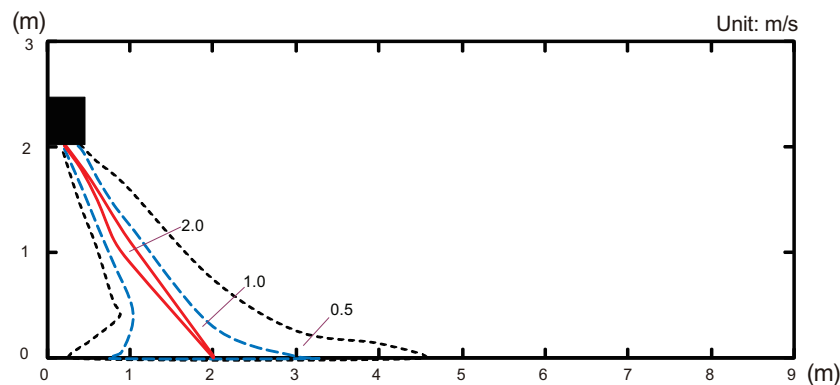

Model: ASYG18LFCA

Measuring conditions	Fan speed	Operation mode
	HIGH	FAN

Top view
Vertical airflow direction louver: Up
Horizontal airflow direction louver: Center

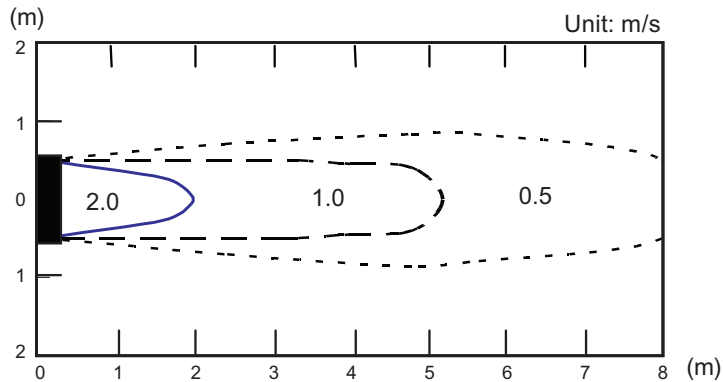

Top view
Vertical airflow direction louver: Up
Horizontal airflow direction louver: Left & Right

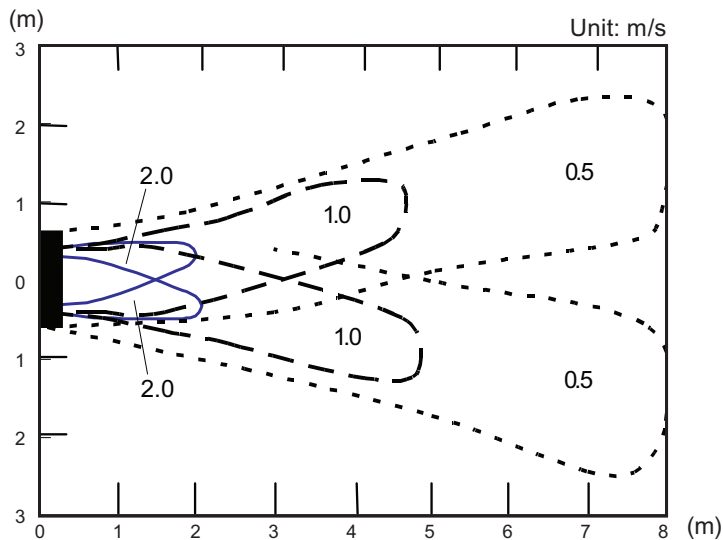

Side view
Vertical airflow direction louver: Up
Horizontal airflow direction louver: Center

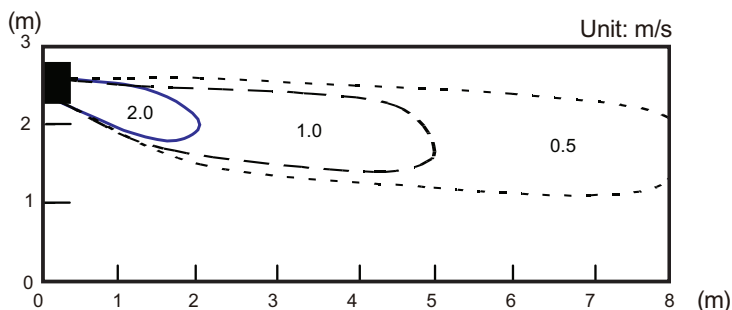

Side view
Vertical airflow direction louver: Down
Horizontal airflow direction louver: Center

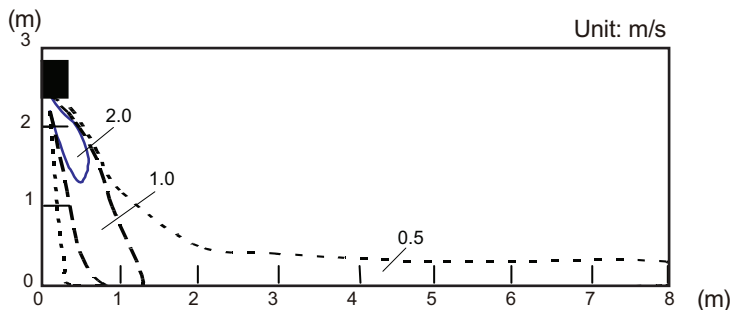

Models: ASYG24LFCA and ASYG24LFCC

MULTI TYPE
5, 6 ROOMS TYPE

MULTI TYPE
5, 6 ROOMS TYPE

Measuring conditions	Fan speed	Operation mode
	HIGH	FAN

Top view
Vertical airflow direction louver: Up
Horizontal airflow direction louver: Center

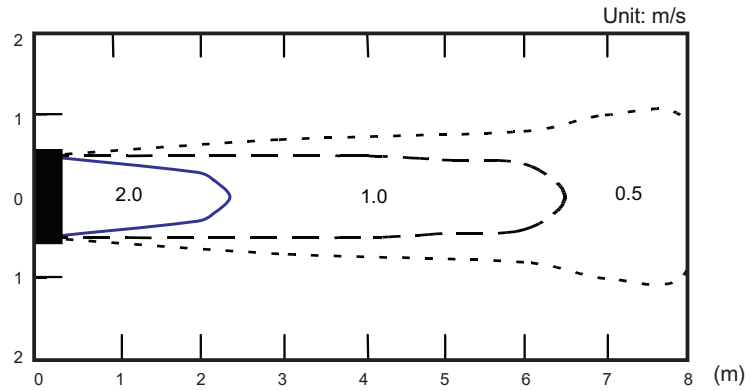

Top view
Vertical airflow direction louver: Up
Horizontal airflow direction louver: Left & Right

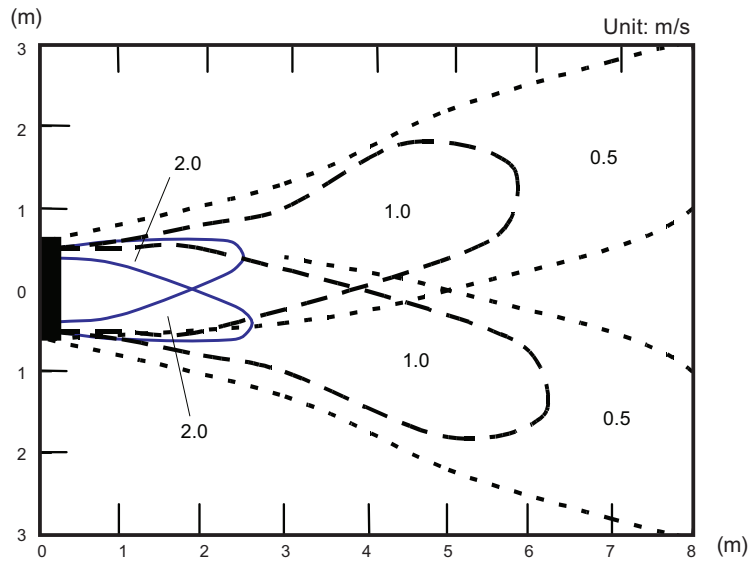

Side view
Vertical airflow direction louver: Up
Horizontal airflow direction louver: Center

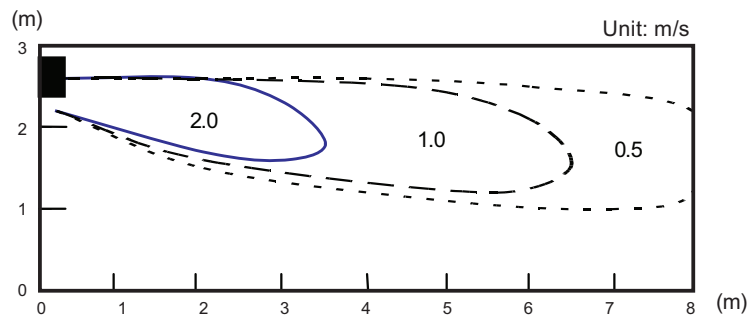

Side view
Vertical airflow direction louver: Down
Horizontal airflow direction louver: Center

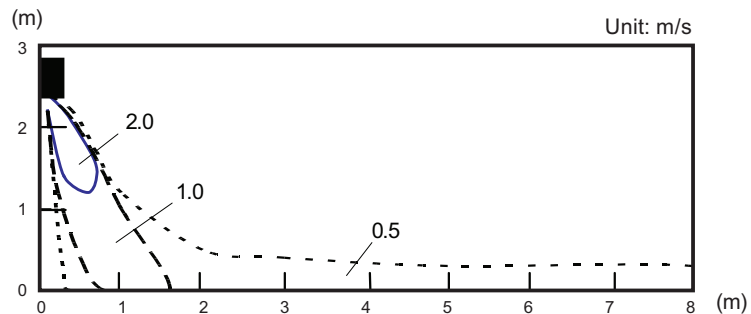

5-5. Floor/Ceiling type

Model: ABYG14LVTA (Under ceiling)

Measuring conditions	Fan speed	Operation mode
	HIGH	FAN

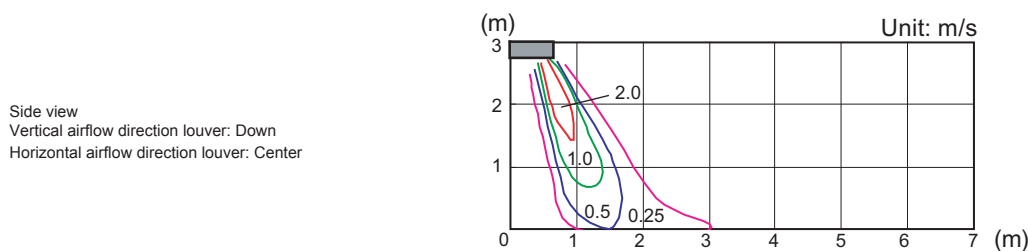
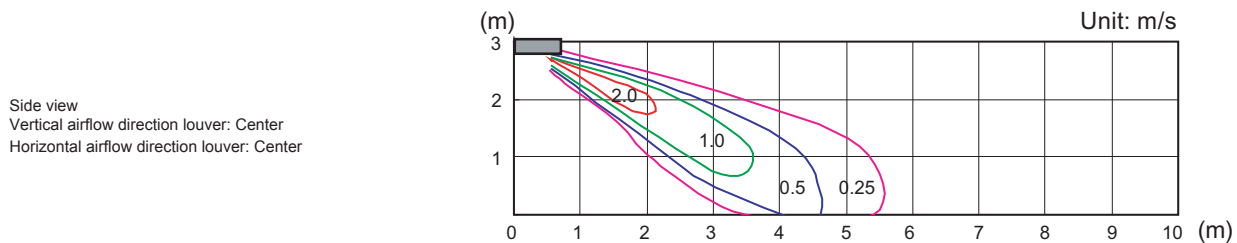
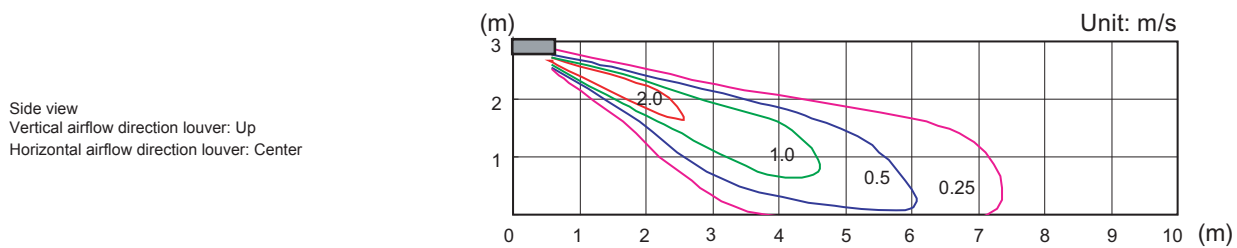
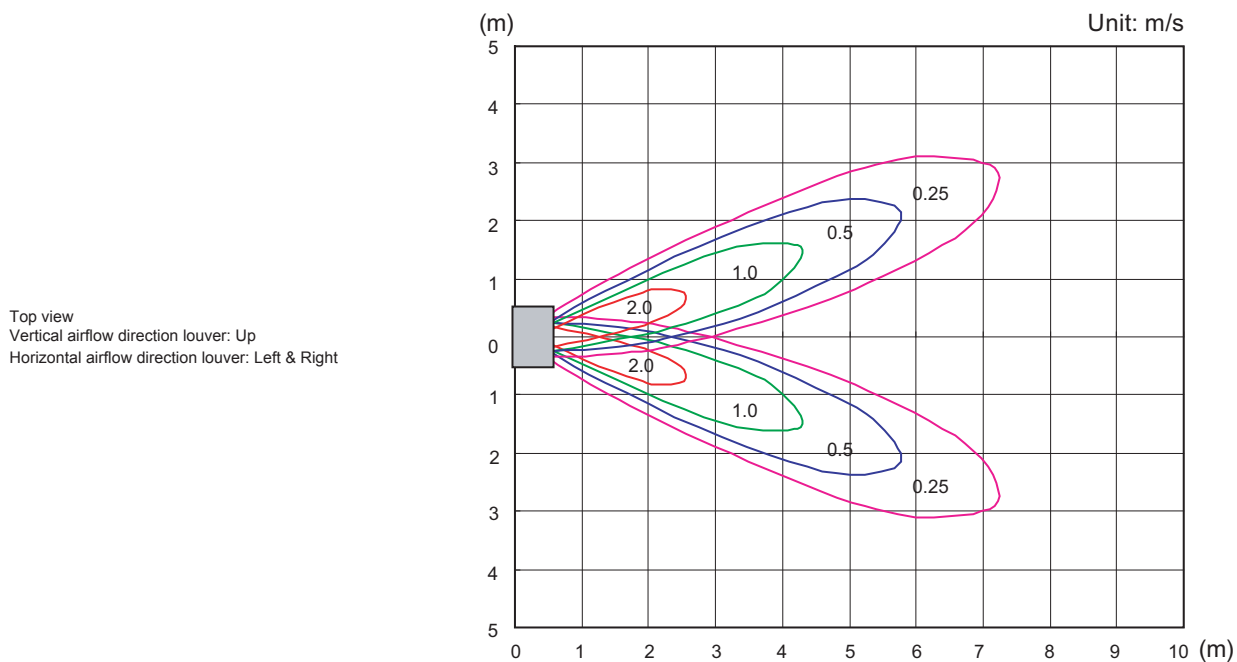
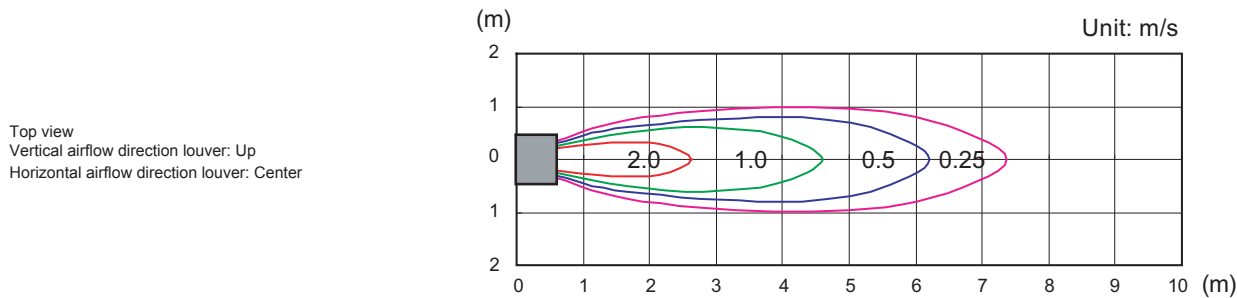

Model: ABYG14LVTA (Floor console)

MULTI TYPE
5, 6 ROOMS TYPE

MULTI TYPE
5, 6 ROOMS TYPE

Measuring conditions	Fan speed	Operation mode
	HIGH	FAN

Top view
Vertical airflow direction louver: Up
Horizontal airflow direction louver: Center

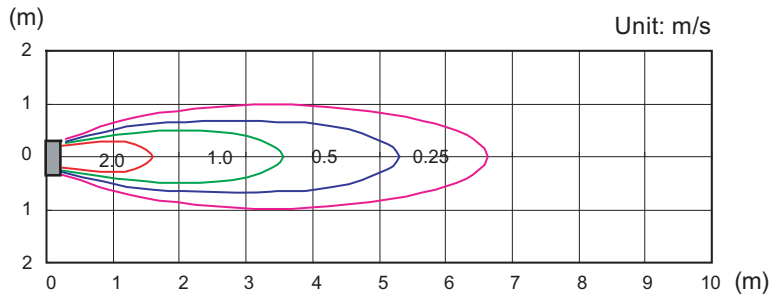

Top view
Vertical airflow direction louver: Up
Horizontal airflow direction louver: Left & Right

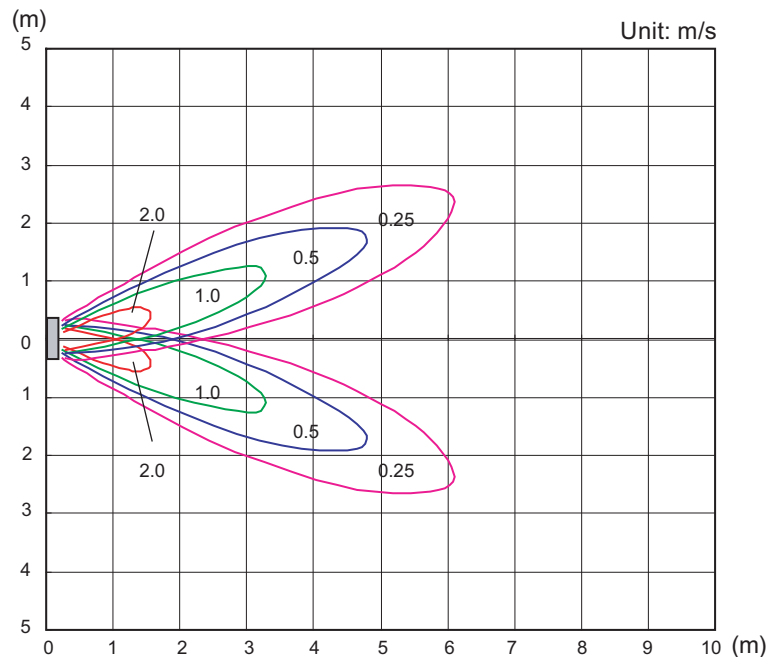

Side view
Vertical airflow direction louver: Down
Horizontal airflow direction louver: Center

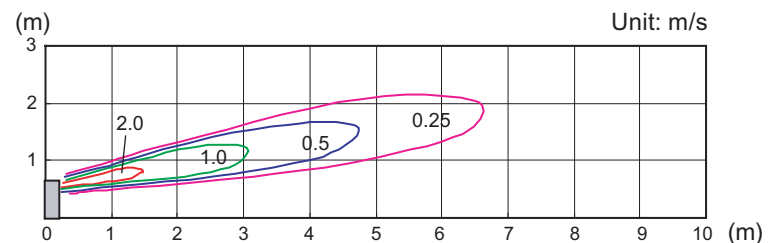

Side view
Vertical airflow direction louver: Center
Horizontal airflow direction louver: Center

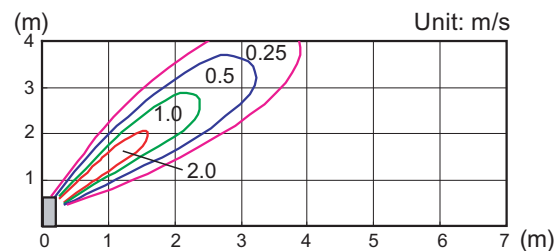

Side view
Vertical airflow direction louver: Up
Horizontal airflow direction louver: Center

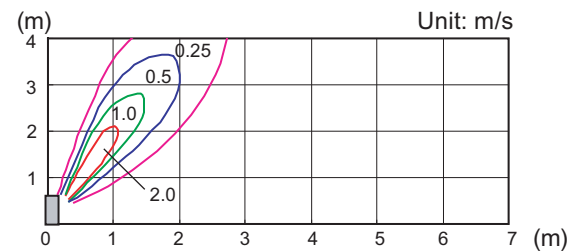

Model: ABYG18LVTB (Under ceiling)

MULTI TYPE
5, 6 ROOMS TYPE

MULTI TYPE
5, 6 ROOMS TYPE

Measuring conditions	Fan speed	Operation mode
	HIGH	FAN

Top view
Vertical airflow direction louver: Up
Horizontal airflow direction louver: Center

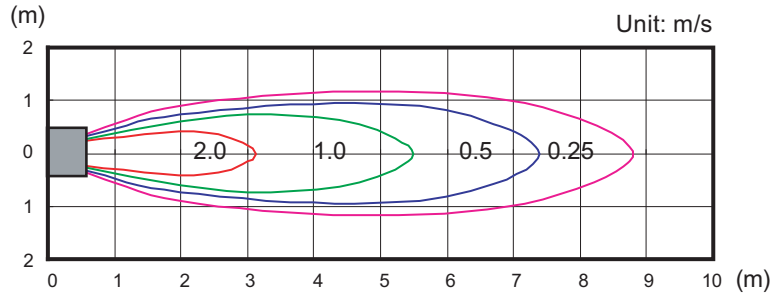

Top view
Vertical airflow direction louver: Up
Horizontal airflow direction louver: Left & Right

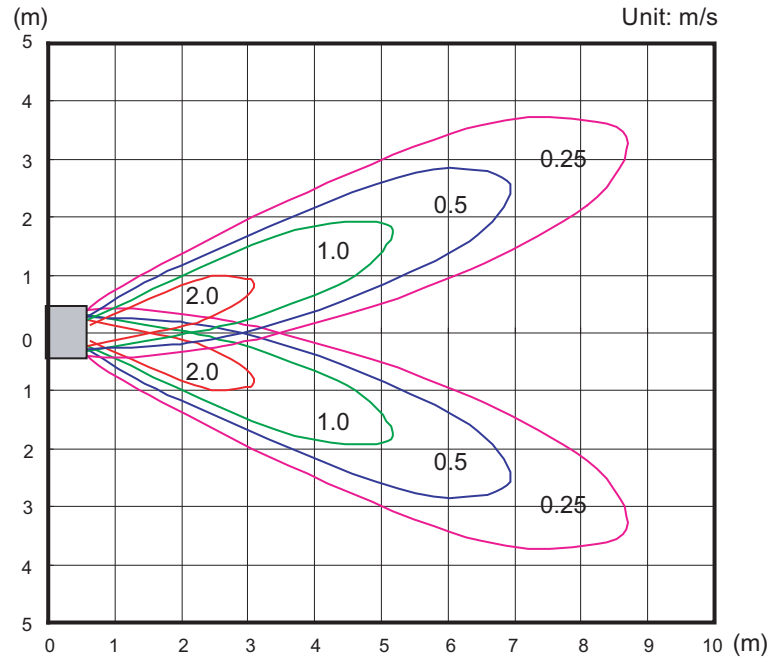

Side view
Vertical airflow direction louver: Up
Horizontal airflow direction louver: Center

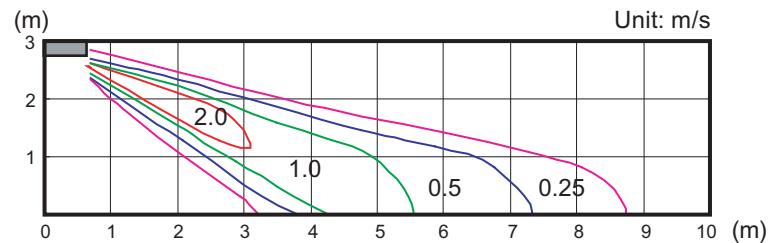

Side view
Vertical airflow direction louver: Center
Horizontal airflow direction louver: Center

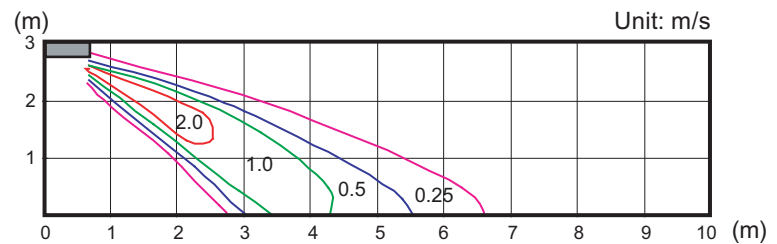

Side view
Vertical airflow direction louver: Down
Horizontal airflow direction louver: Center

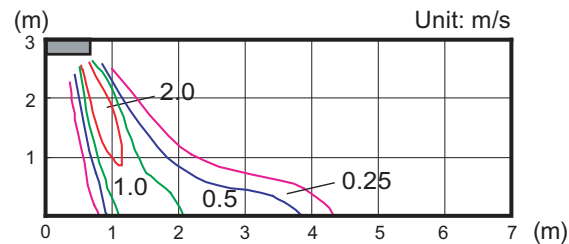

Model: ABYG18LVTB (Floor console)

MULTI TYPE
5, 6 ROOMS TYPE

MULTI TYPE
5, 6 ROOMS TYPE

Measuring conditions	Fan speed	Operation mode
	HIGH	FAN

Top view
Vertical airflow direction louver: Up
Horizontal airflow direction louver: Center

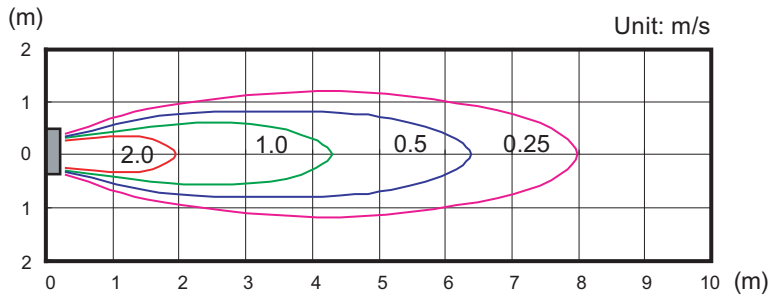

Top view
Vertical airflow direction louver: Up
Horizontal airflow direction louver: Left & Right

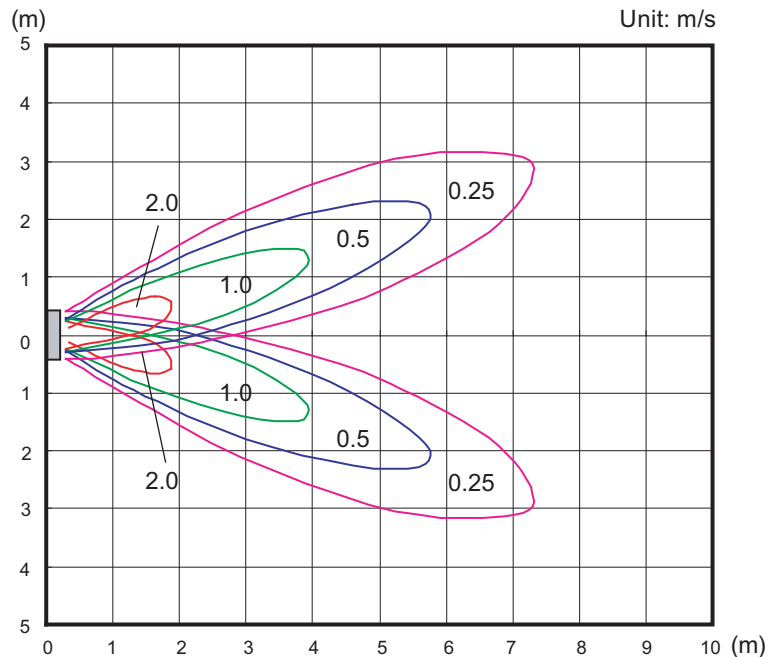

Side view
Vertical airflow direction louver: Down
Horizontal airflow direction louver: Center

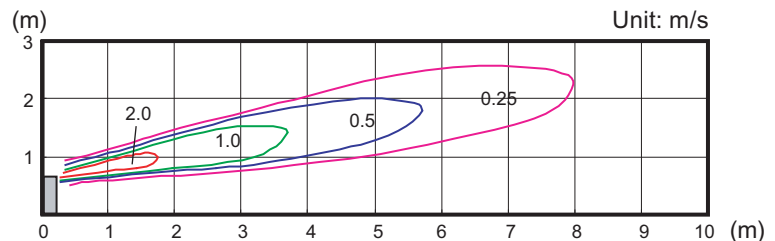

Side view
Vertical airflow direction louver: Center
Horizontal airflow direction louver: Center

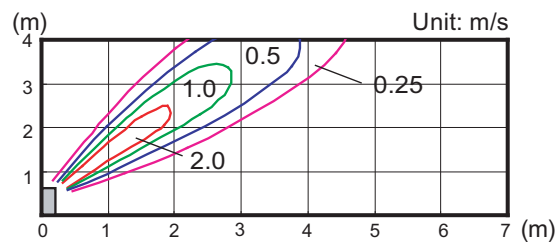

Side view
Vertical airflow direction louver: Up
Horizontal airflow direction louver: Center



5-6. Floor type

Models: AGYG09LVCA, AGYG12LVCA, and AGYG14LVCA

Measuring conditions	Fan speed	Operation mode	Fan select
	HIGH	FAN	Upper and lower

Top view
Vertical airflow direction louver: Up
Horizontal airflow direction louver: Center

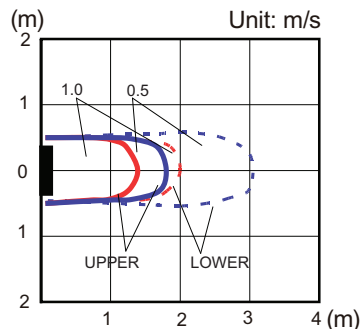

Top view
Vertical airflow direction louver: Up
Horizontal airflow direction louver: Left & Right

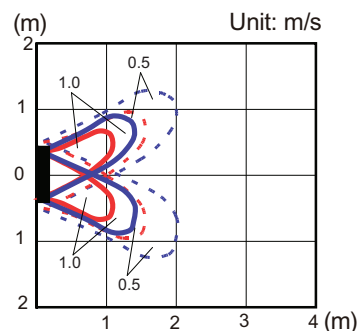

Side view
Vertical airflow direction louver: Up
Horizontal airflow direction louver: Center

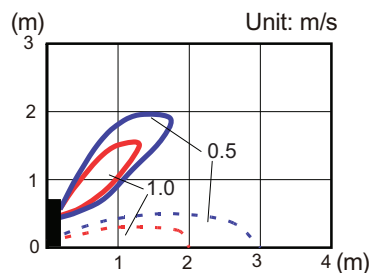

Side view
Vertical airflow direction louver: Down
Horizontal airflow direction louver: Center

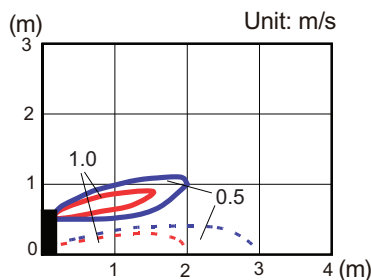

6. Fan performance

6-1. Mini duct type

■ Model: ARYG07LSLAP

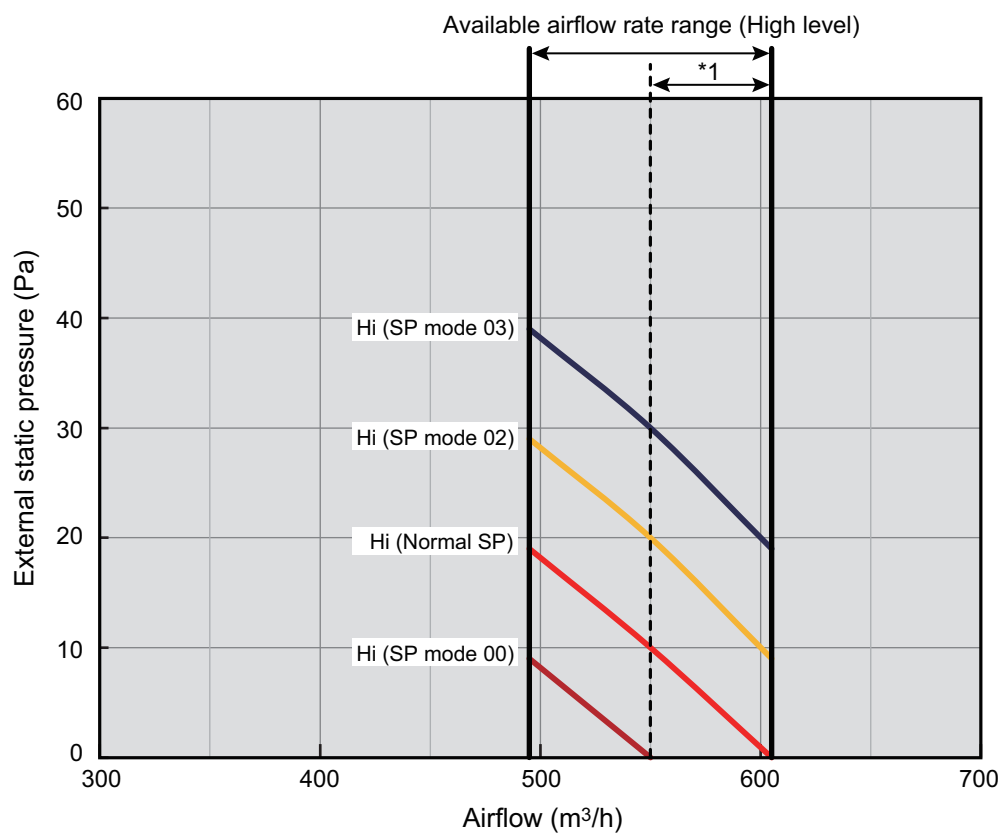
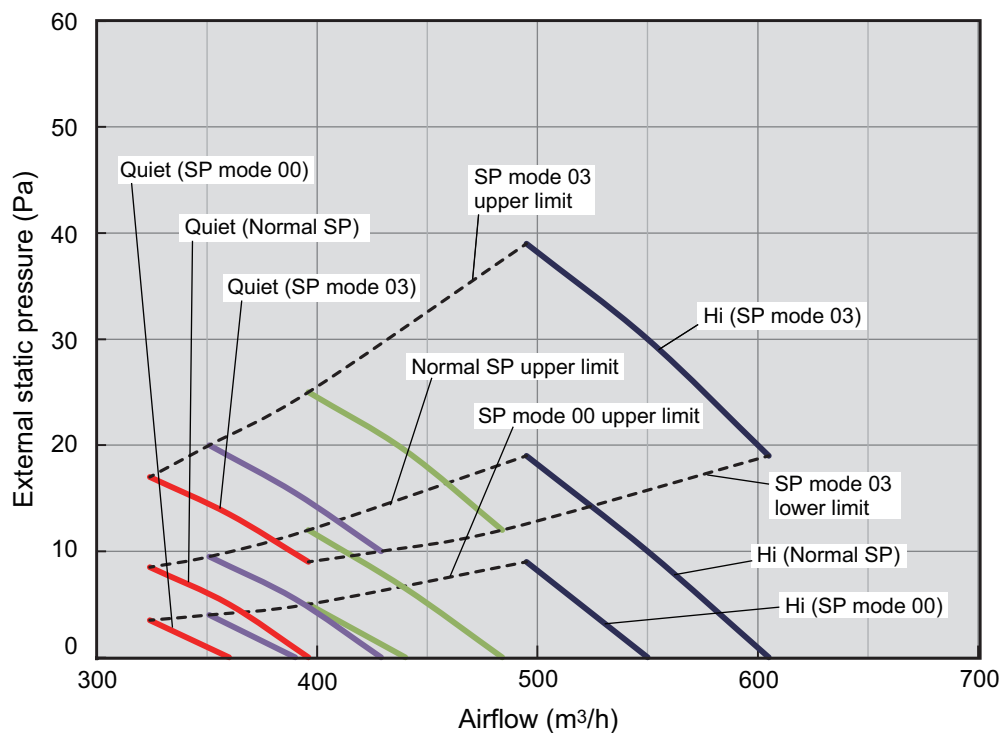

*1: Available airflow rate range when Auto louver grille (option) is installed.

Fan speed: HIGH

Vertical airflow direction louver: Up

● Characteristics of air volume and capacity

• Cooling

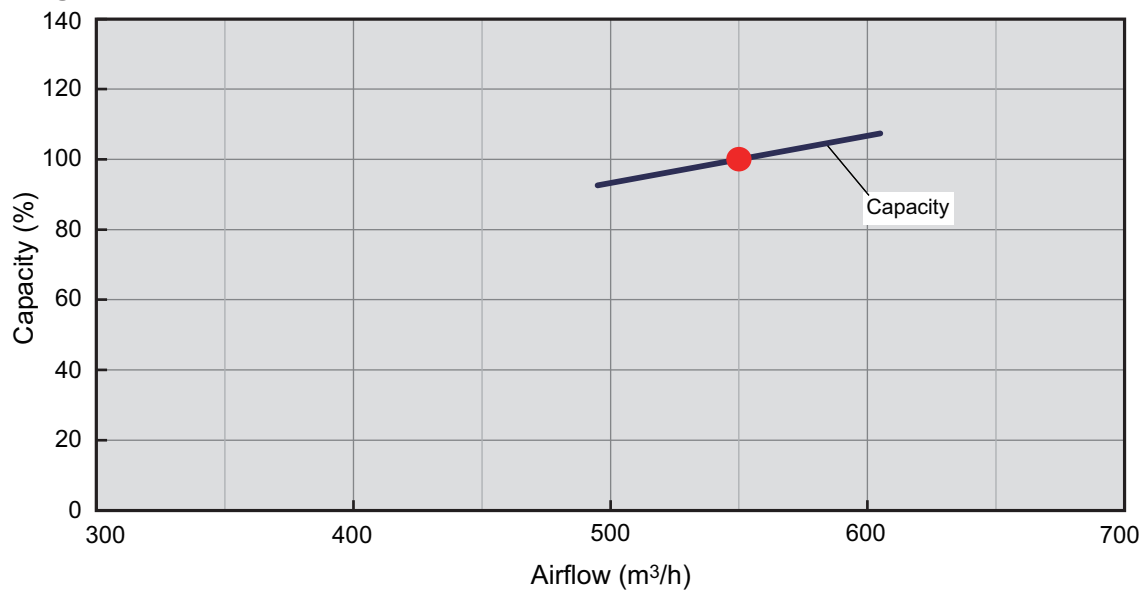

• Heating

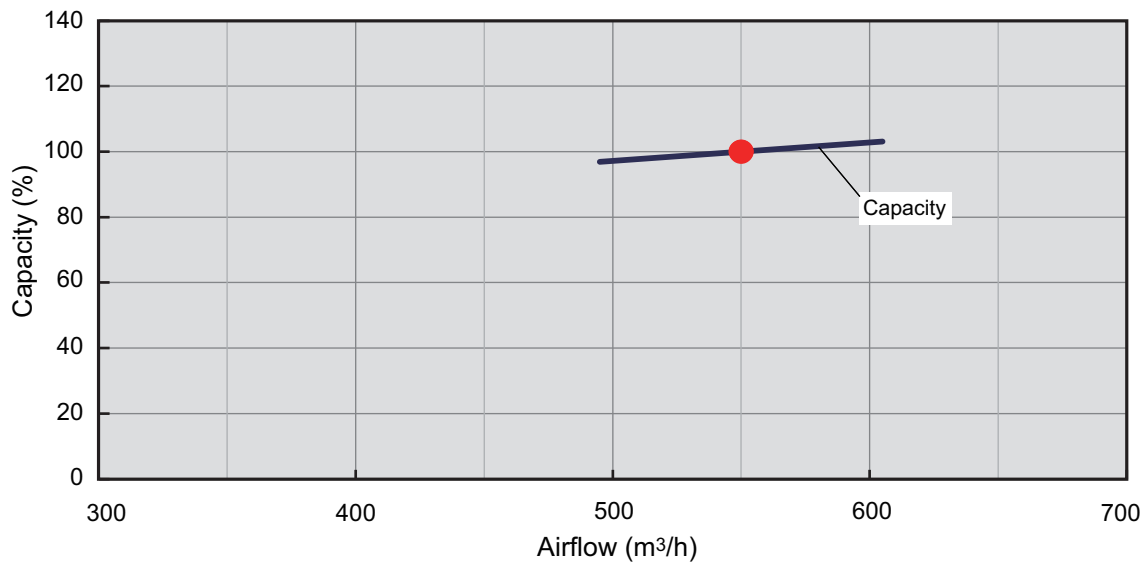

Model: ARYG09LSLAP

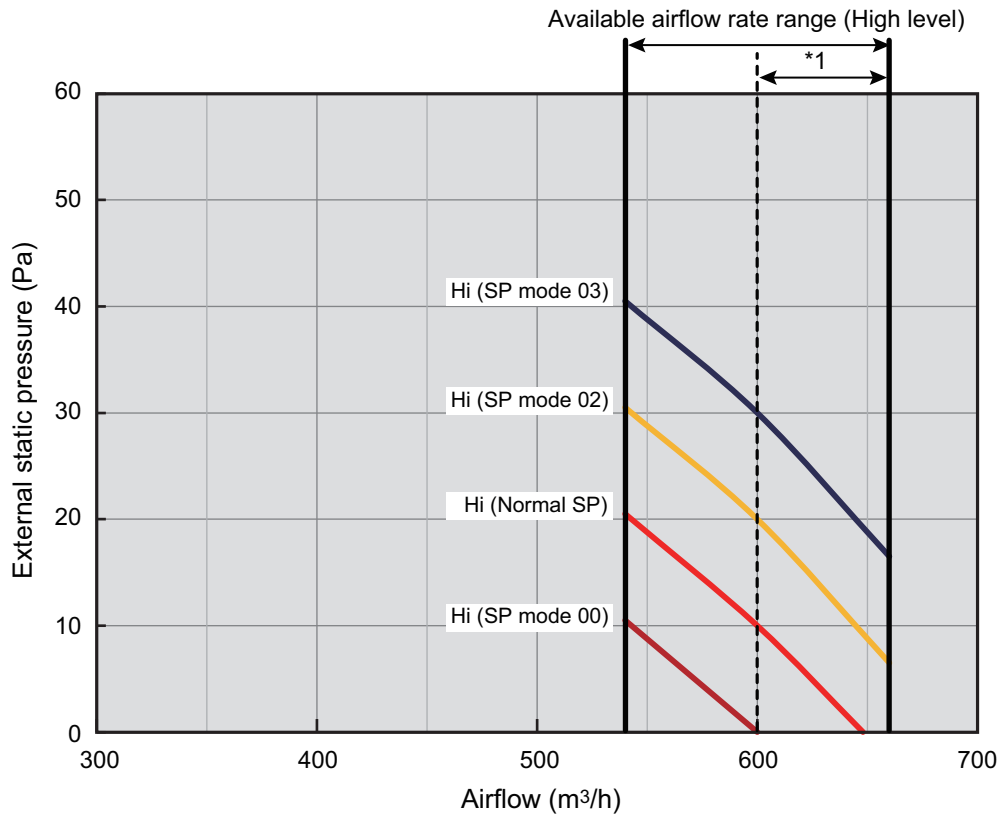
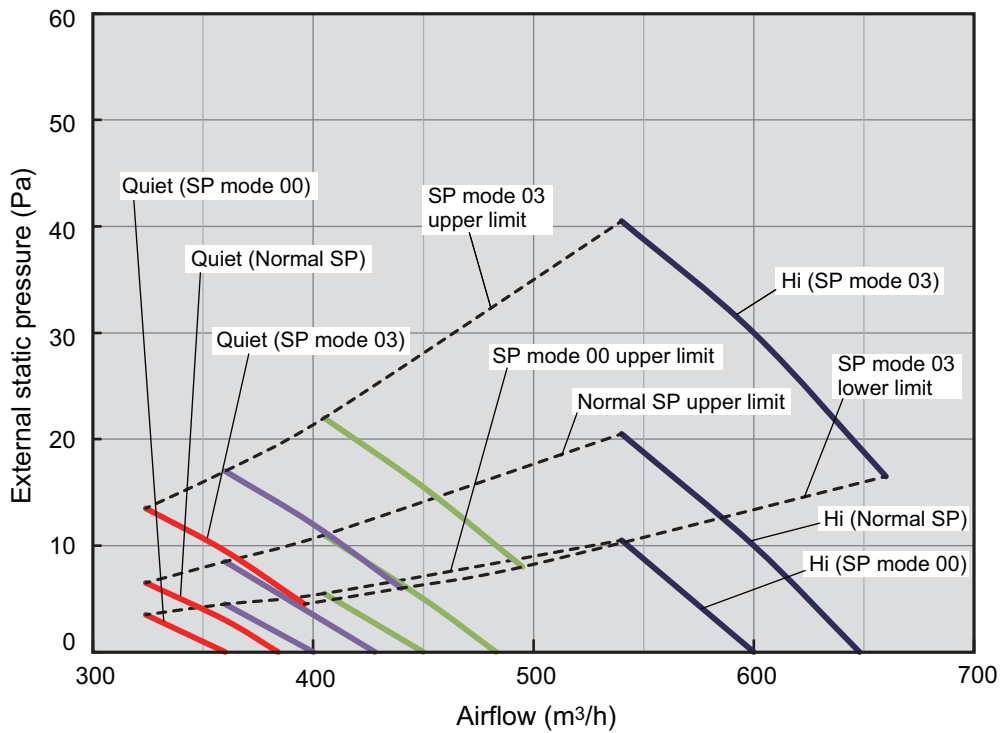

*1: Available airflow rate range when Auto louver grille (option) is installed.
 Fan speed: HIGH
 Vertical airflow direction louver: Up

● Characteristics of air volume and capacity

• Cooling

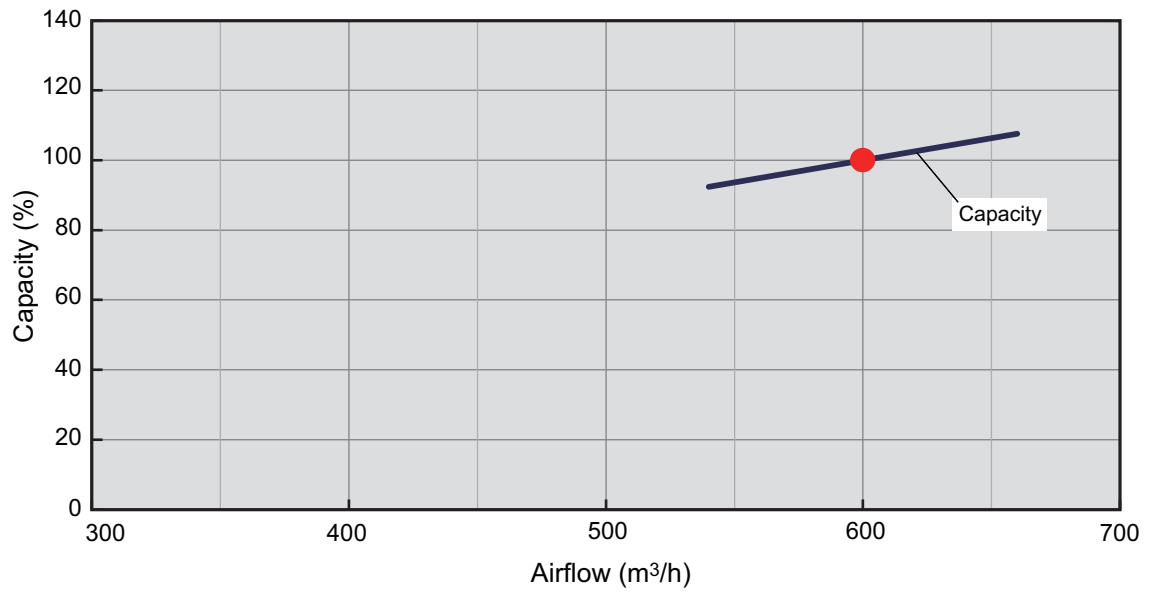

• Heating

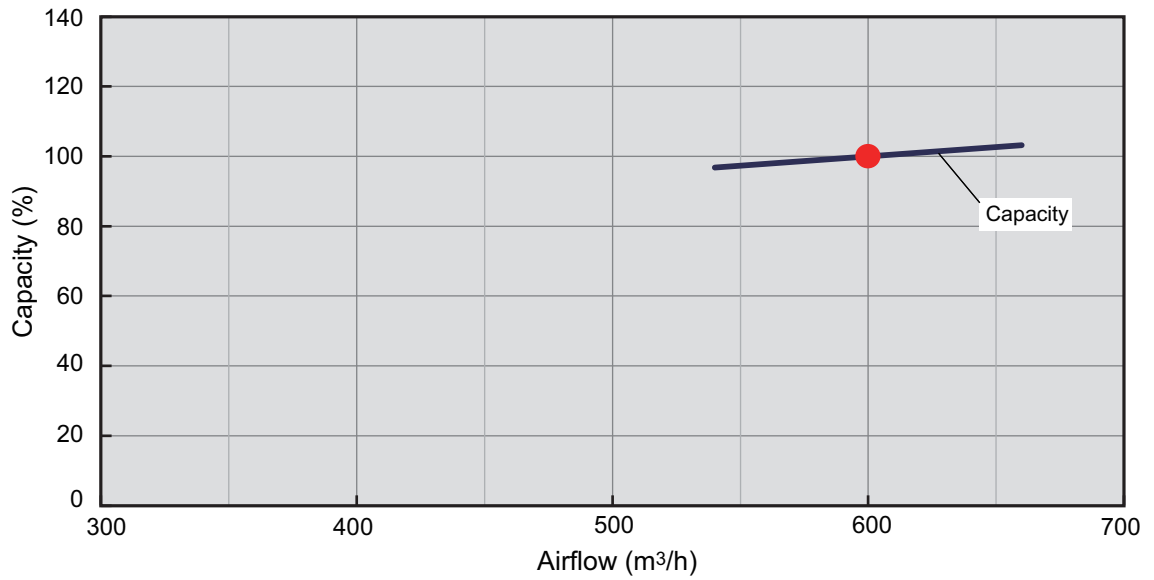

Model: ARYG12LSLAP

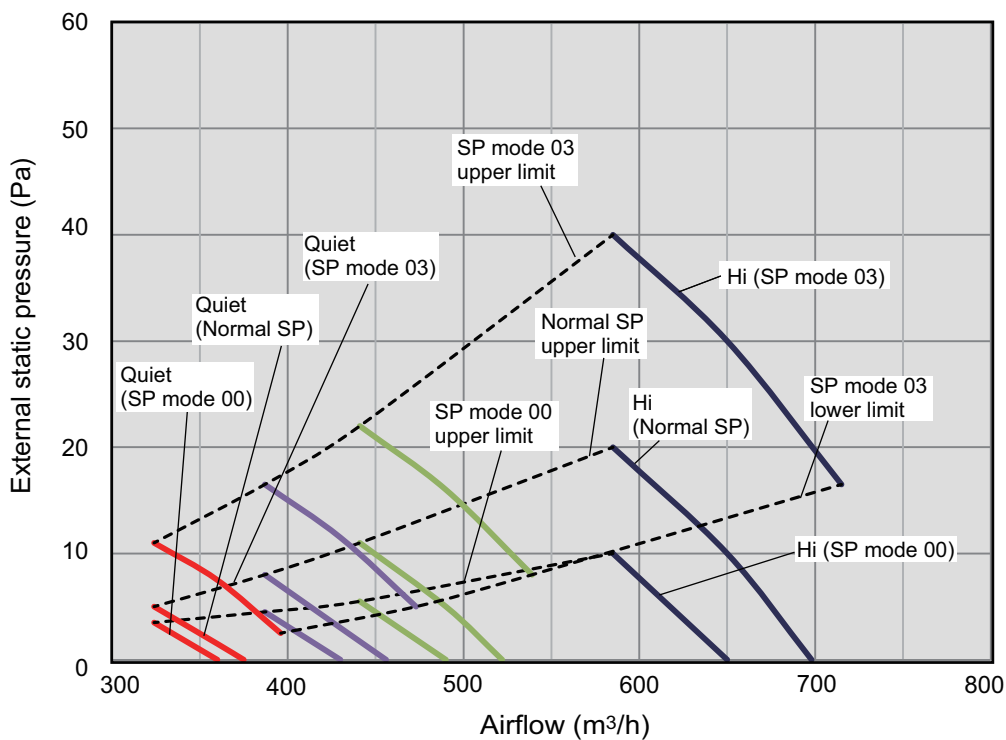

Available airflow rate range (High level)

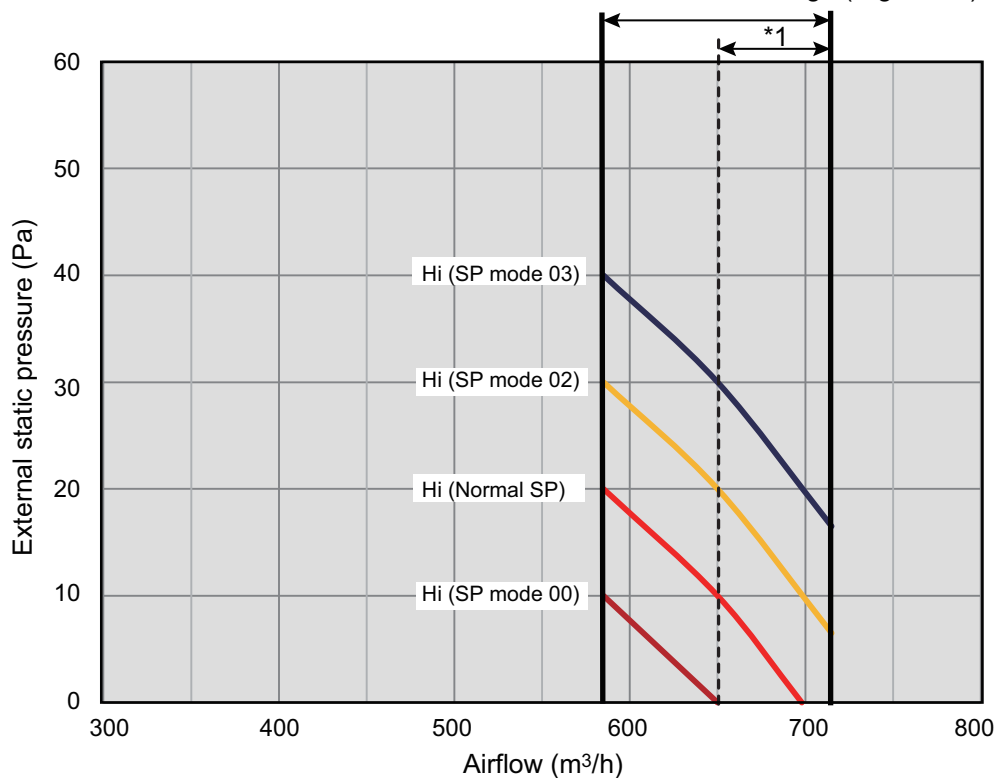

*1: Available airflow rate range when Auto louver grille (option) is installed.

Fan speed: HIGH

Vertical airflow direction louver: Up

● Characteristics of air volume and capacity

• Cooling

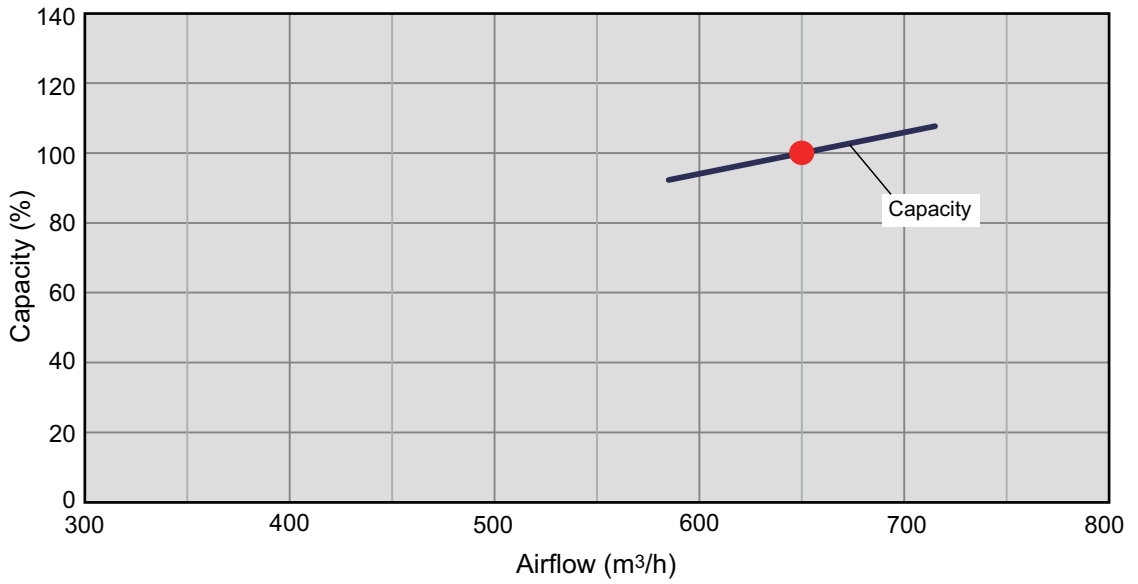

• Heating

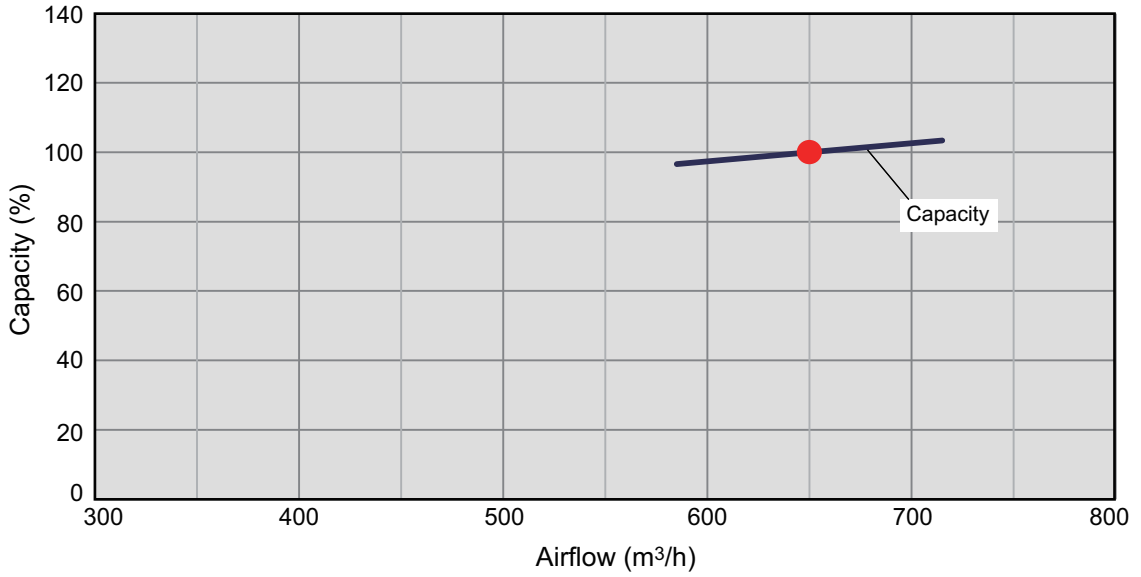

Model: ARYG14LSLAP

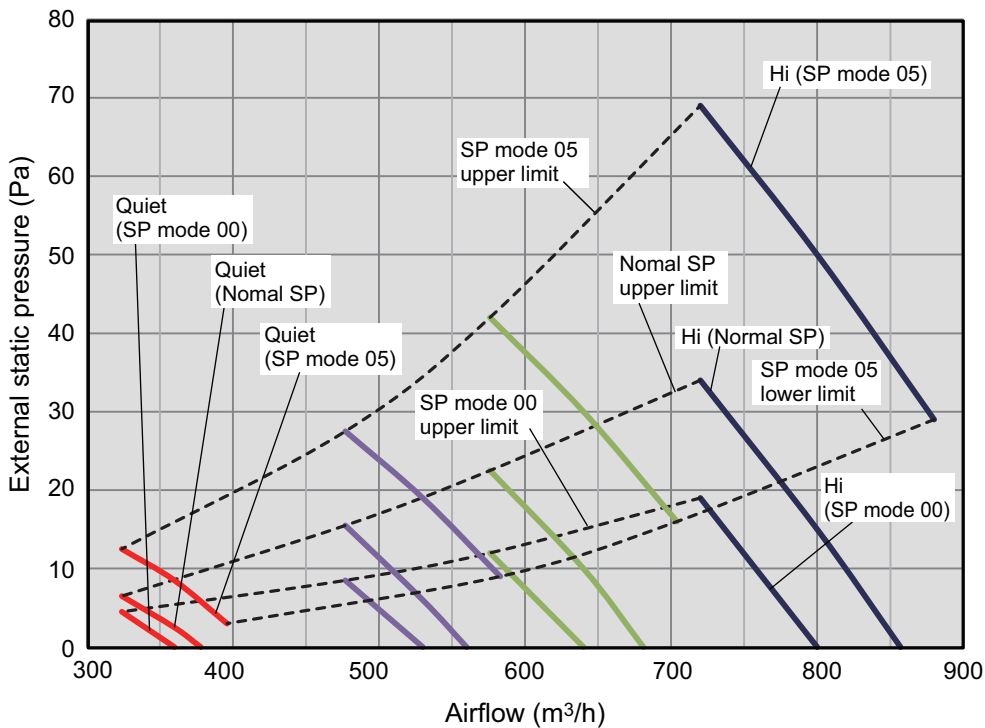

Available airflow rate range (High level)

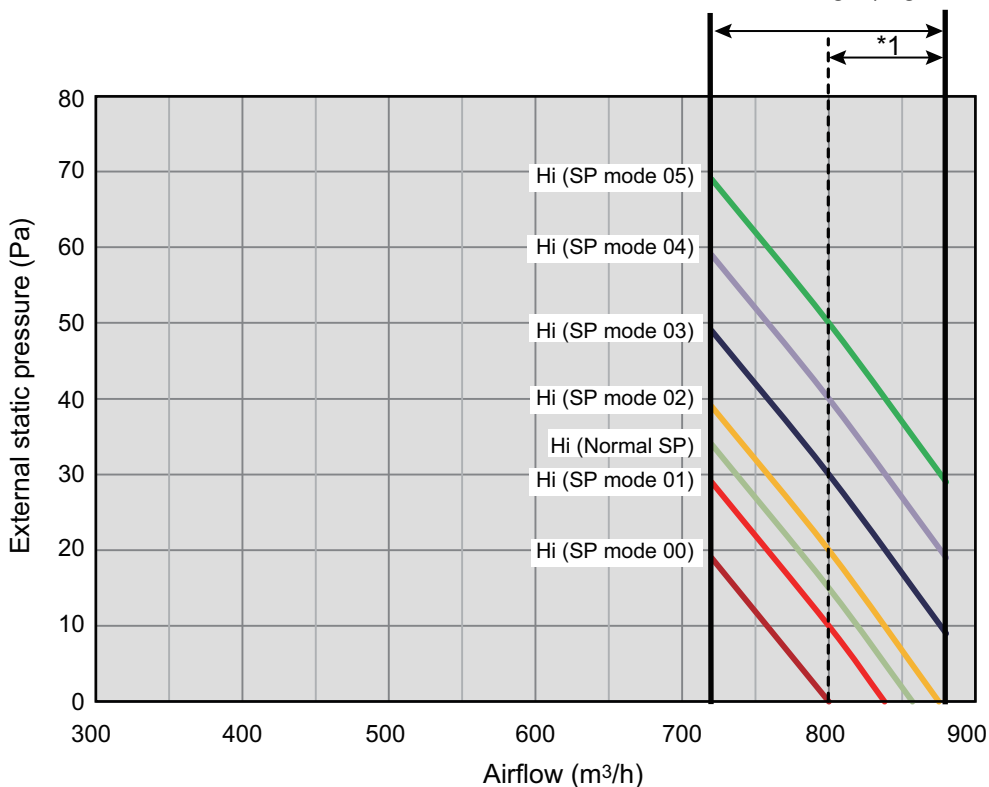

*1: Available airflow rate range when Auto louver grille (option) is installed.
 Fan speed: HIGH
 Vertical airflow direction louver: Up

● Characteristics of air volume and capacity

• Cooling

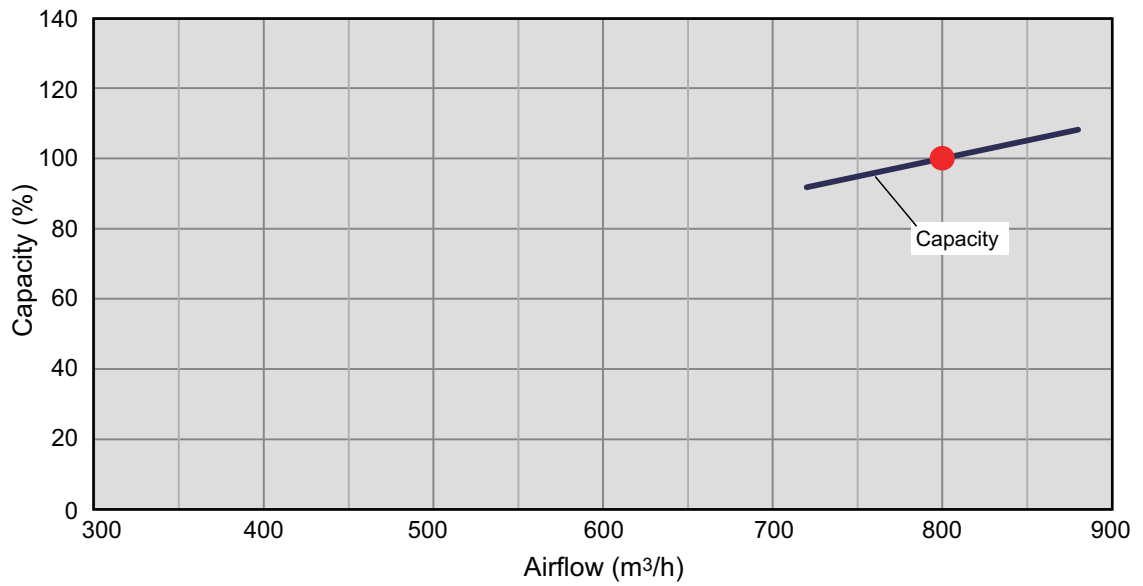

• Heating

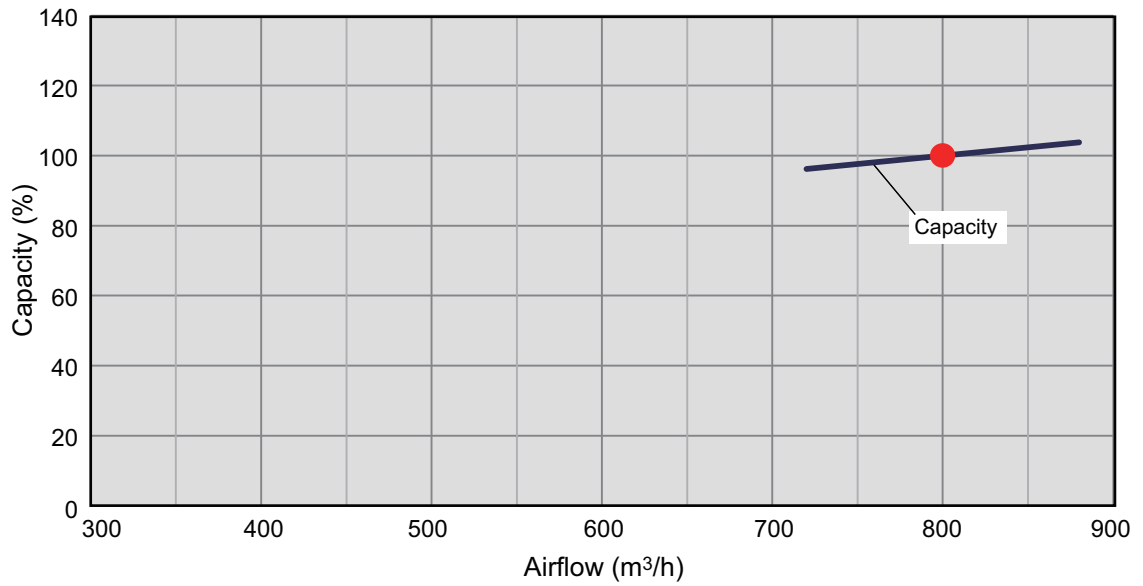

Model: ARYG18LSLAP

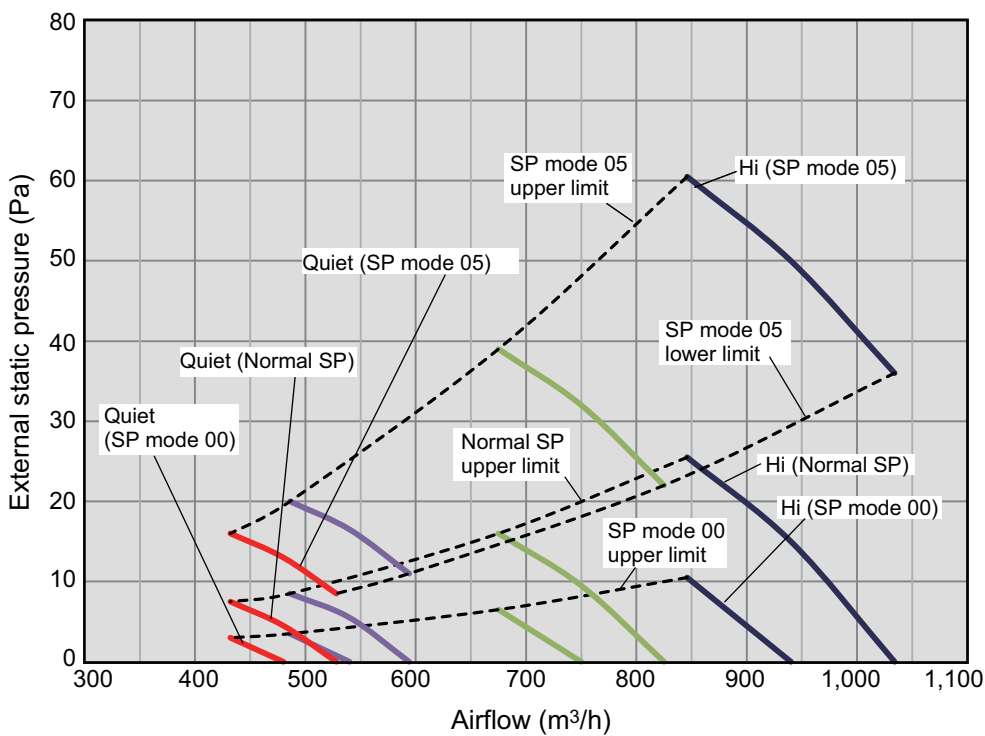

Available airflow rate range (High level)

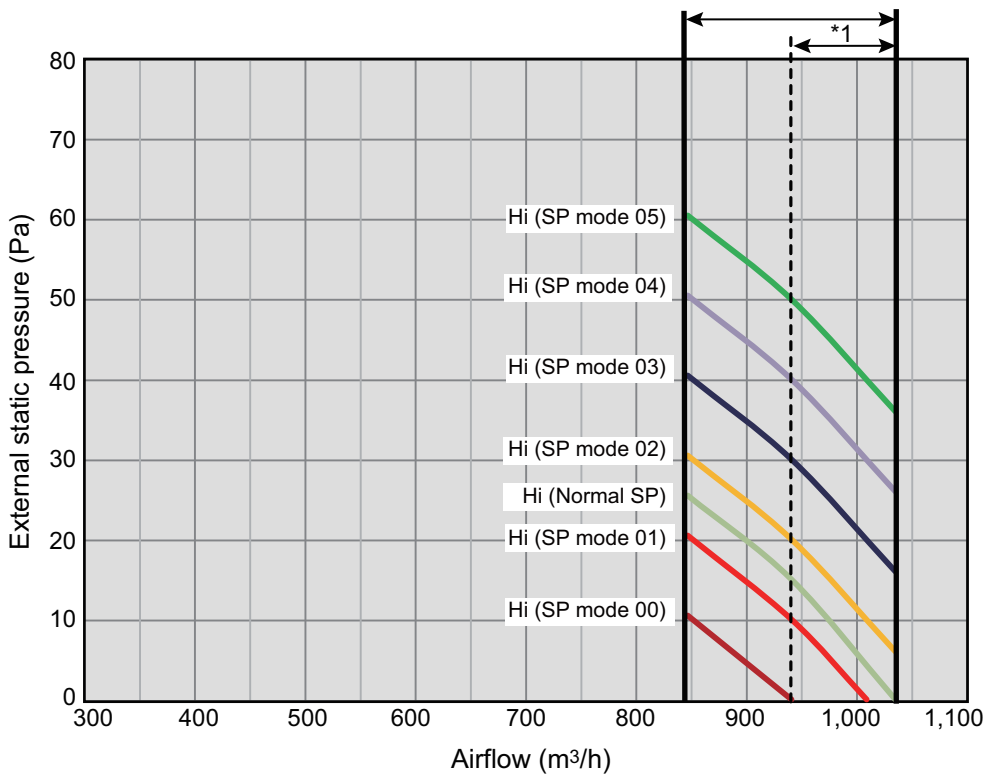

*1: Available airflow rate range when Auto louver grille (option) is installed.
 Fan speed: HIGH
 Vertical airflow direction louver: Up

● Characteristics of air volume and capacity

• Cooling

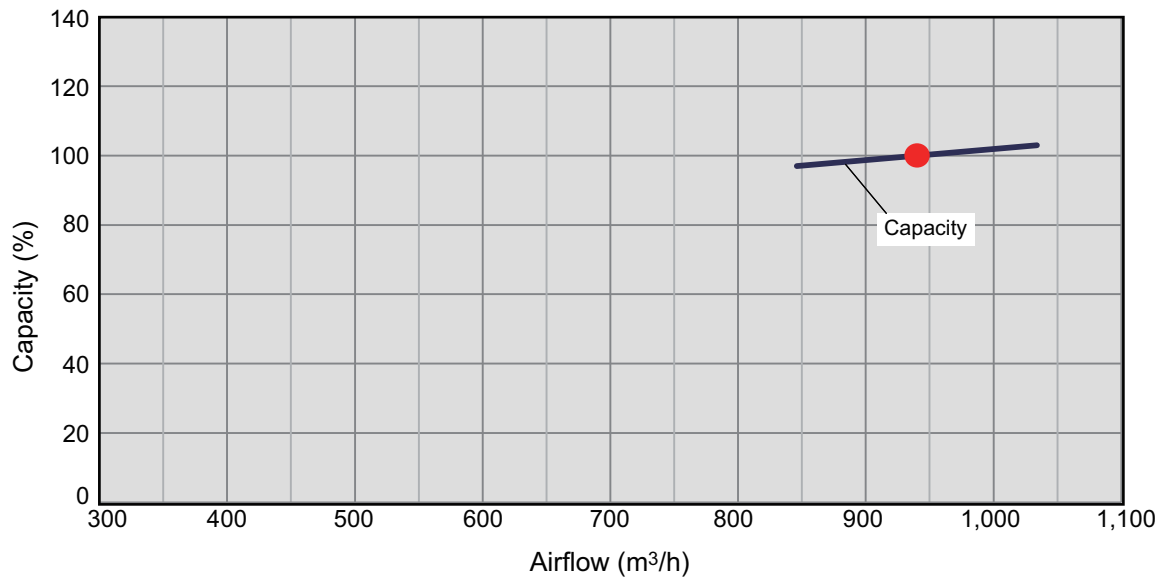

• Heating

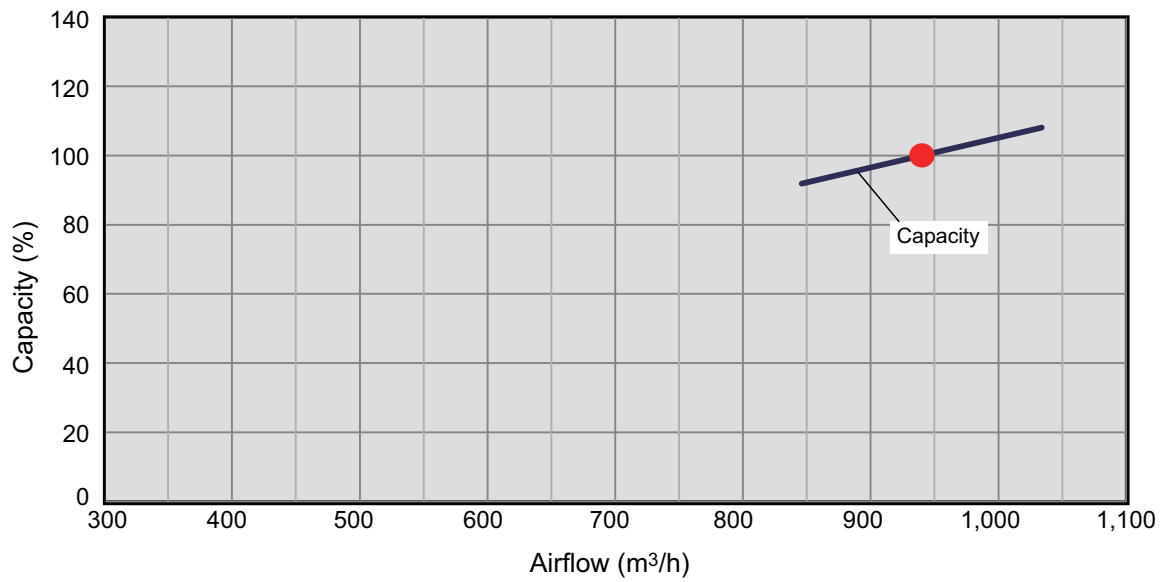

6-2. Slim duct type

Model: ARYG07LLTA

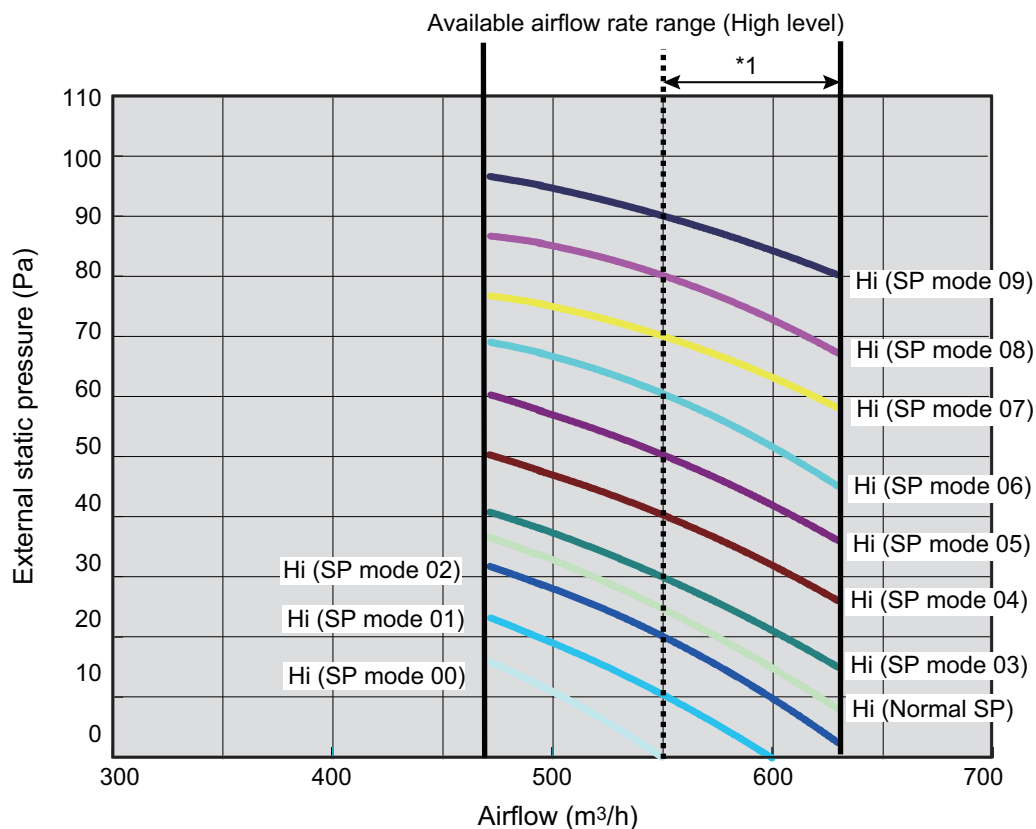
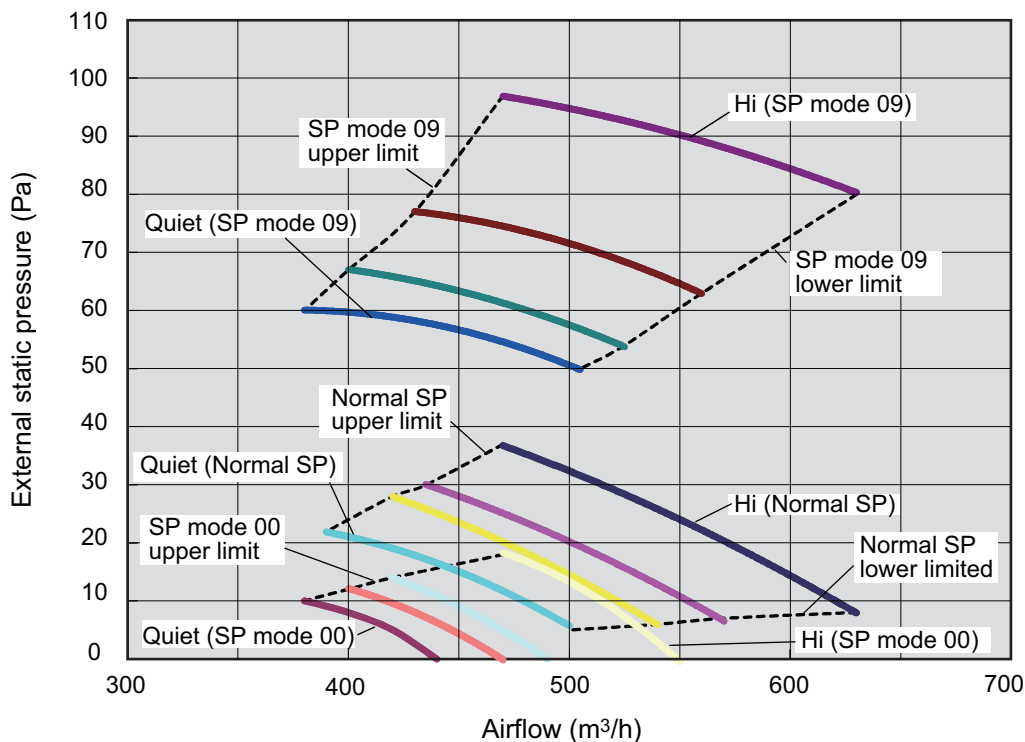

*1: Available airflow rate range when Auto louver grille (option) is installed.
 Fan speed: HIGH
 Vertical airflow direction louver: Up

● Characteristics of air volume and capacity

• Cooling

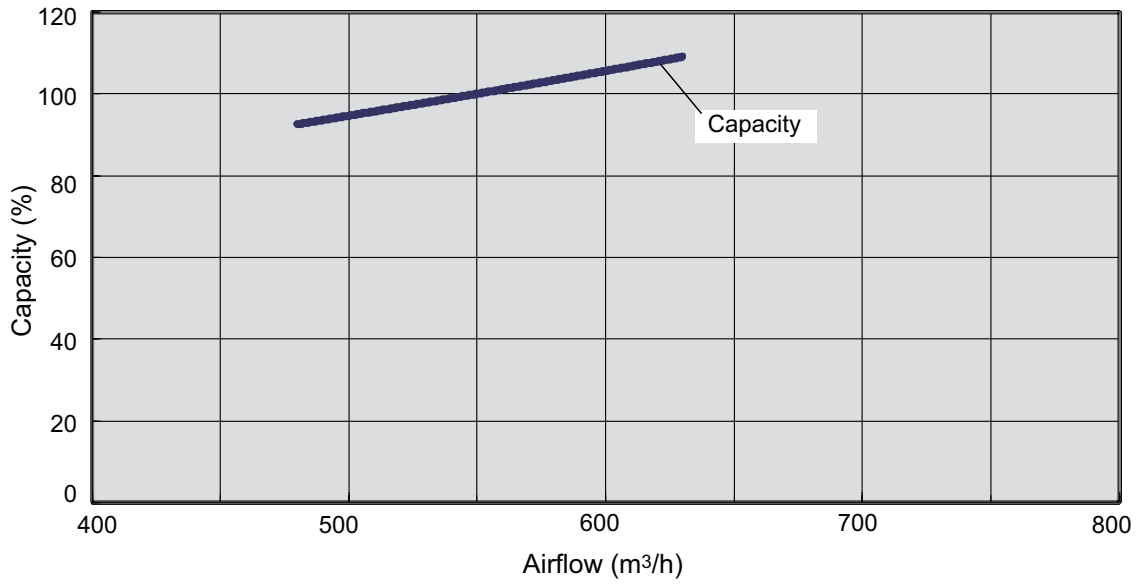

• Heating

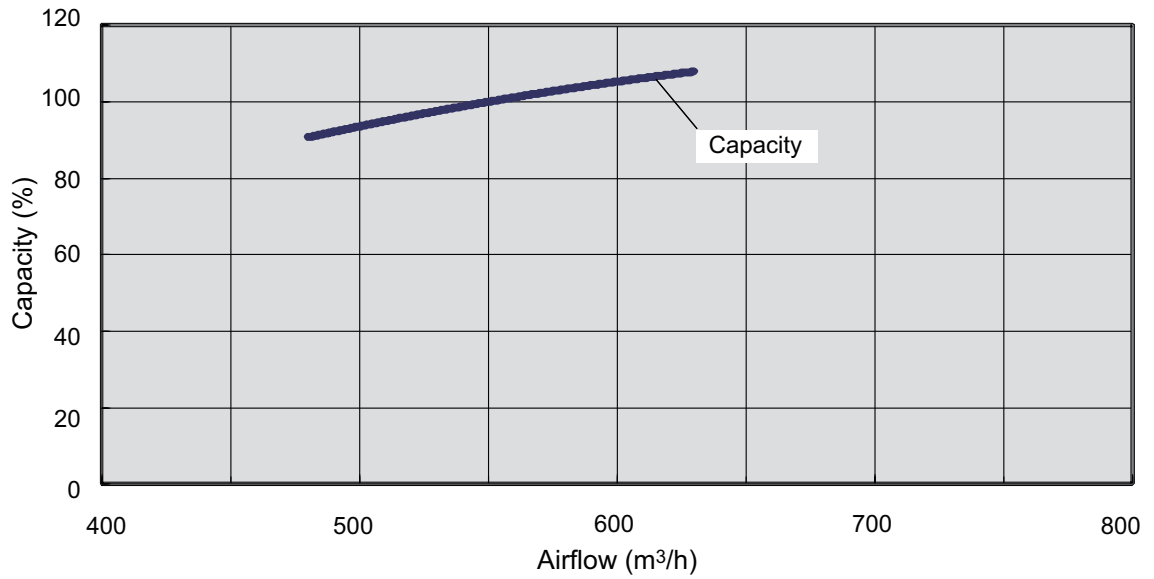

Model: ARYG09LLTA

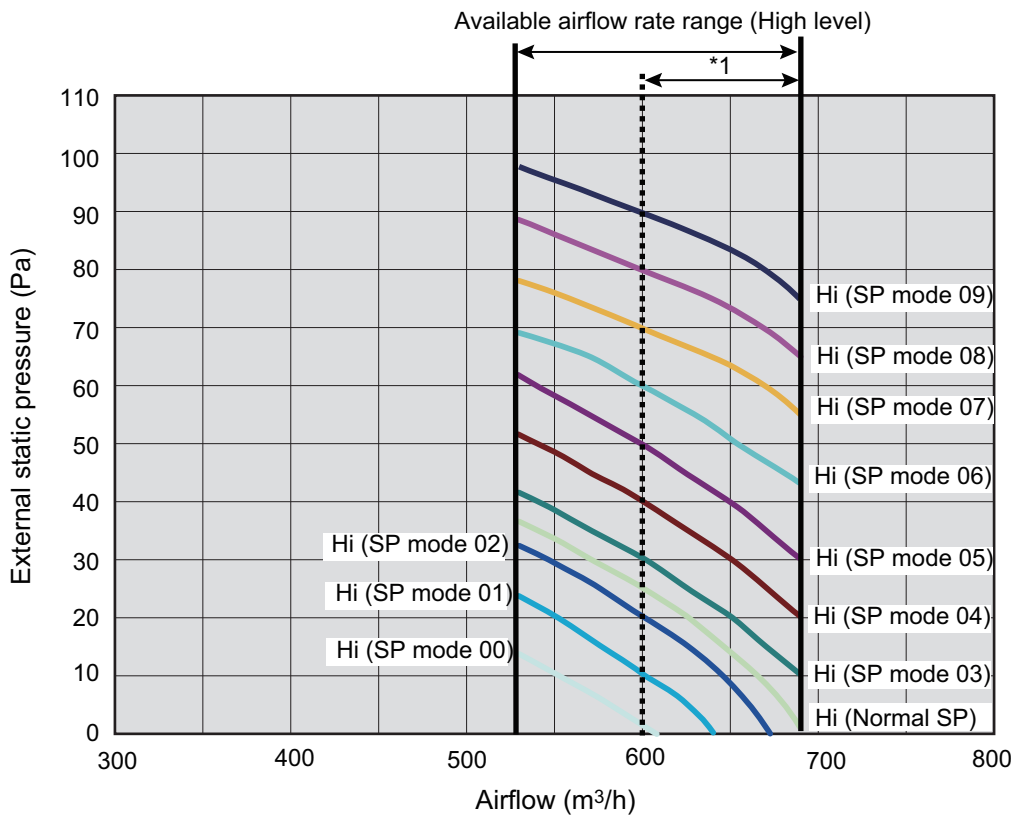
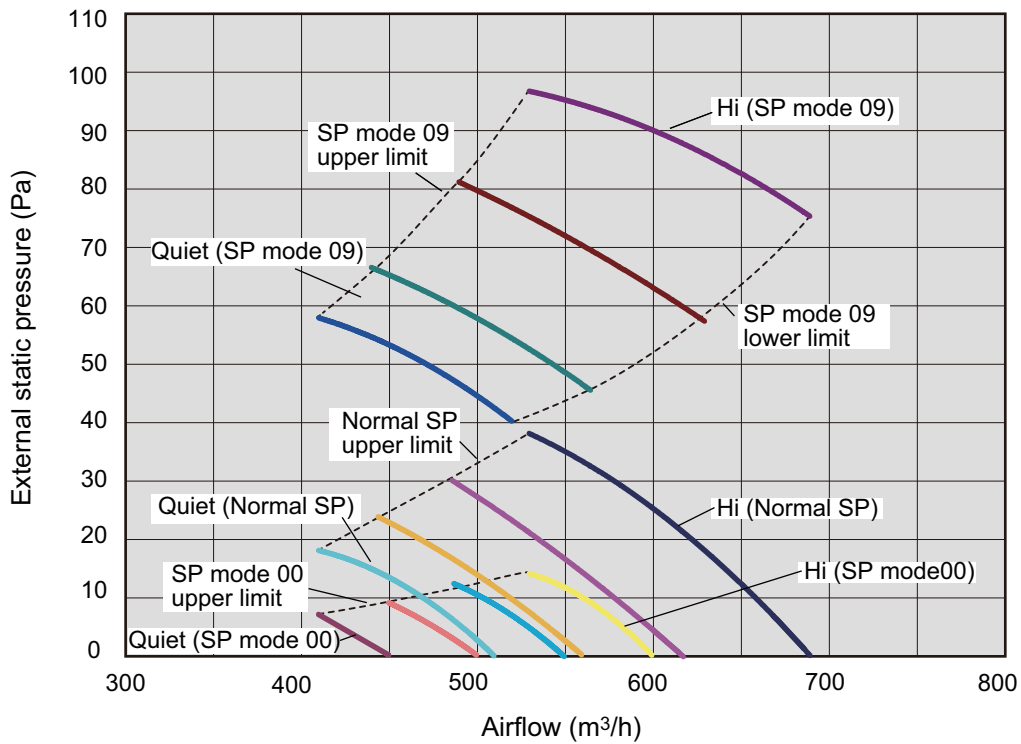

*1: Available airflow rate range when Auto louver grille (option) is installed.
 Fan speed: HIGH
 Vertical airflow direction louver: Up

● Characteristics of air volume and capacity

• Cooling

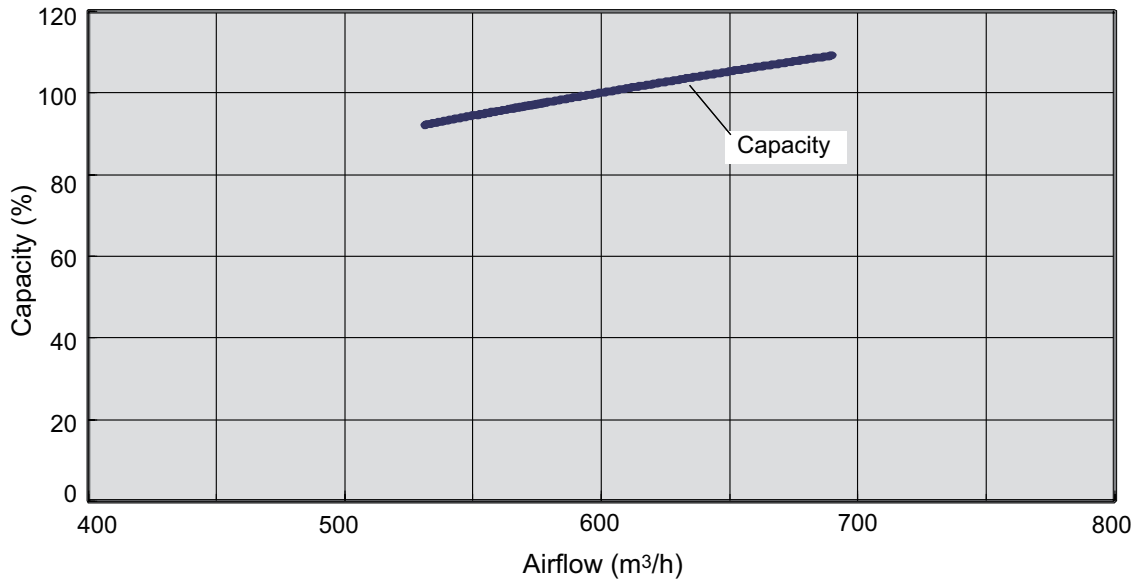

• Heating

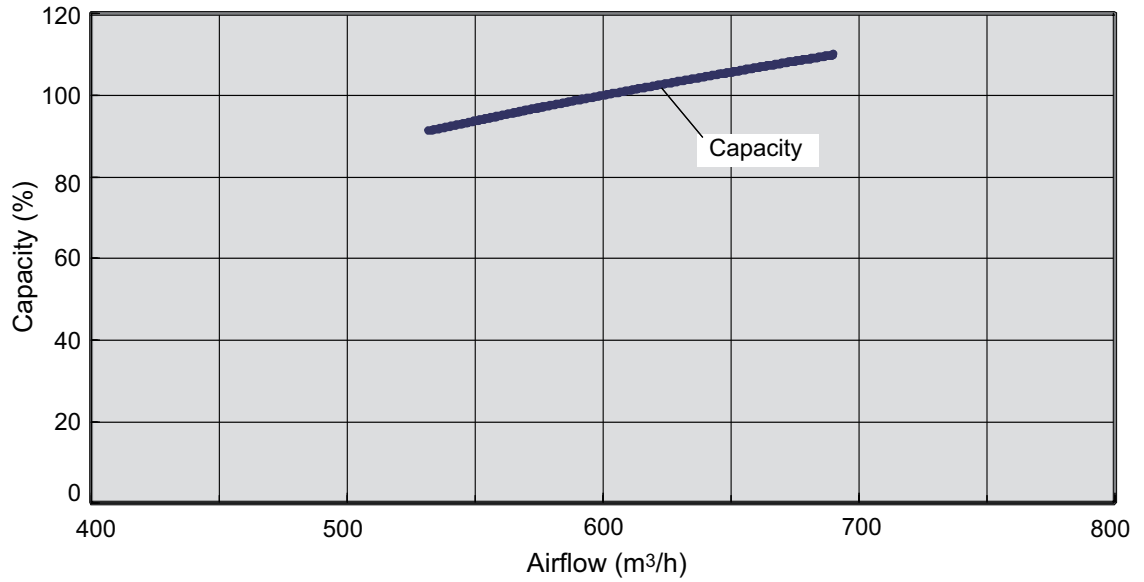

Model: ARYG12LLTB

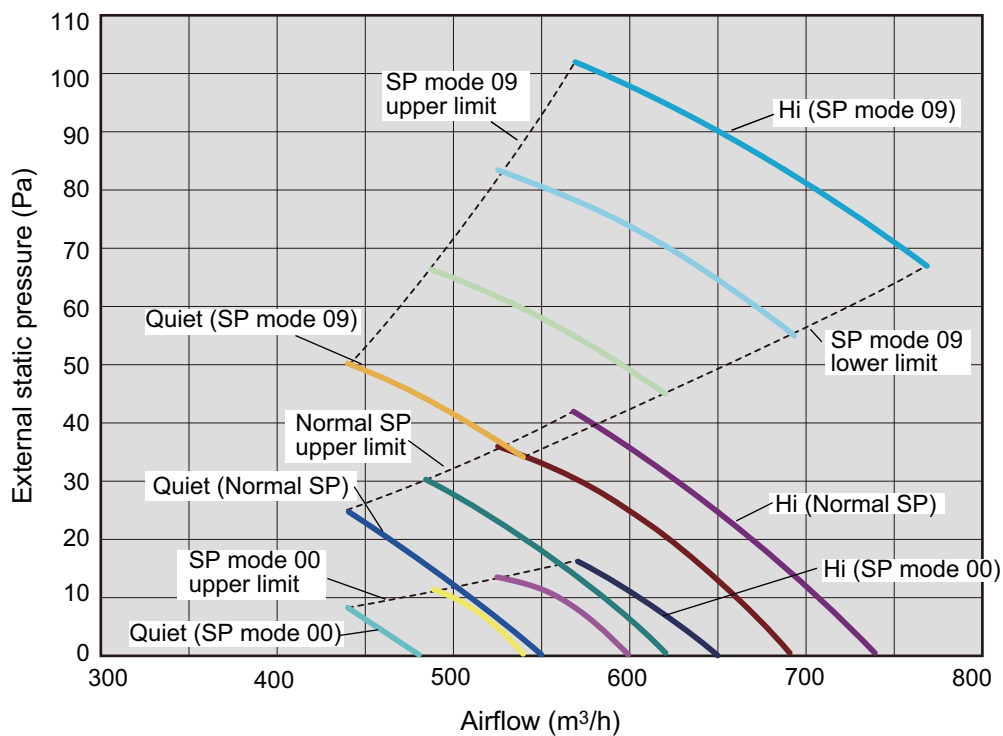

Available airflow rate range (High level)

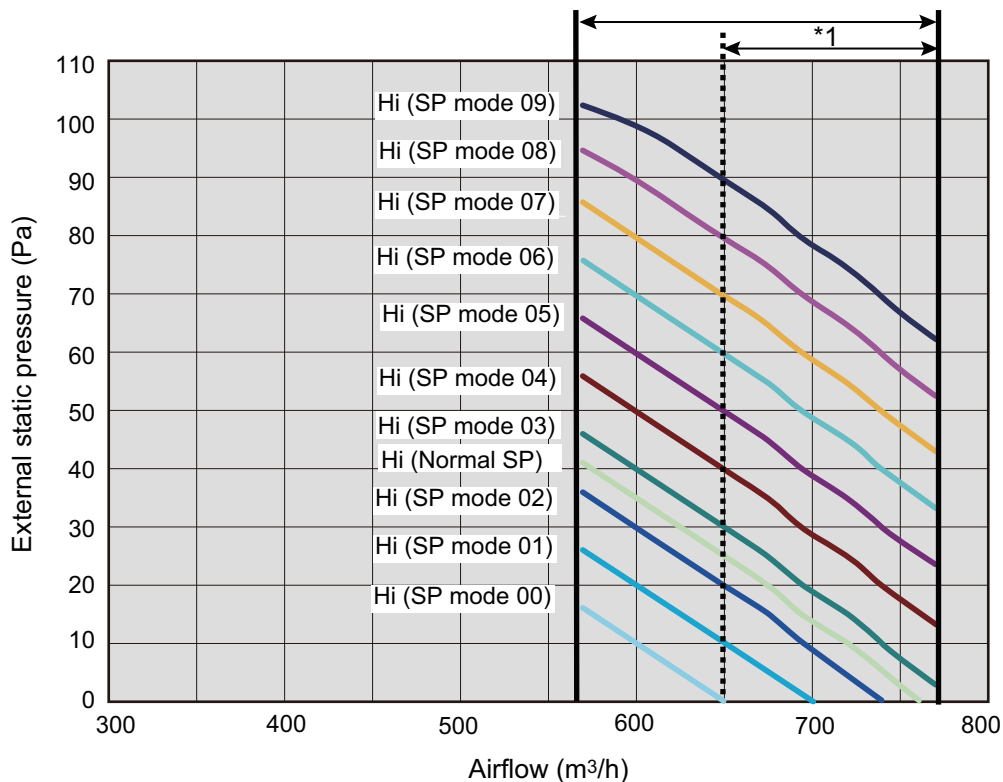

*1: Available airflow rate range when Auto louver grille (option) is installed.
 Fan speed: HIGH
 Vertical airflow direction louver: Up

● Characteristics of air volume and capacity

• Cooling

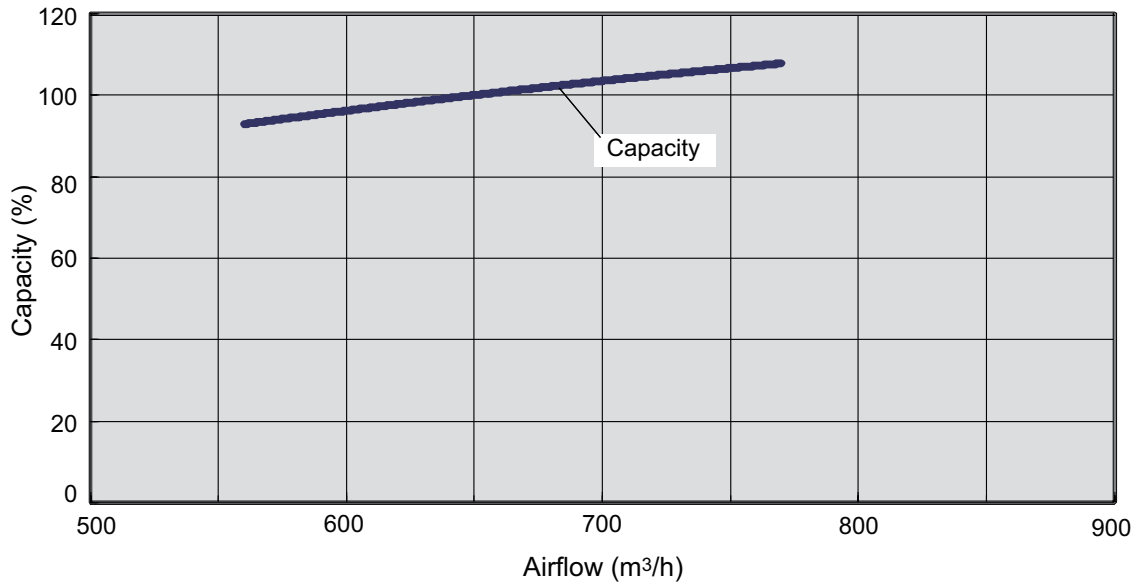

• Heating

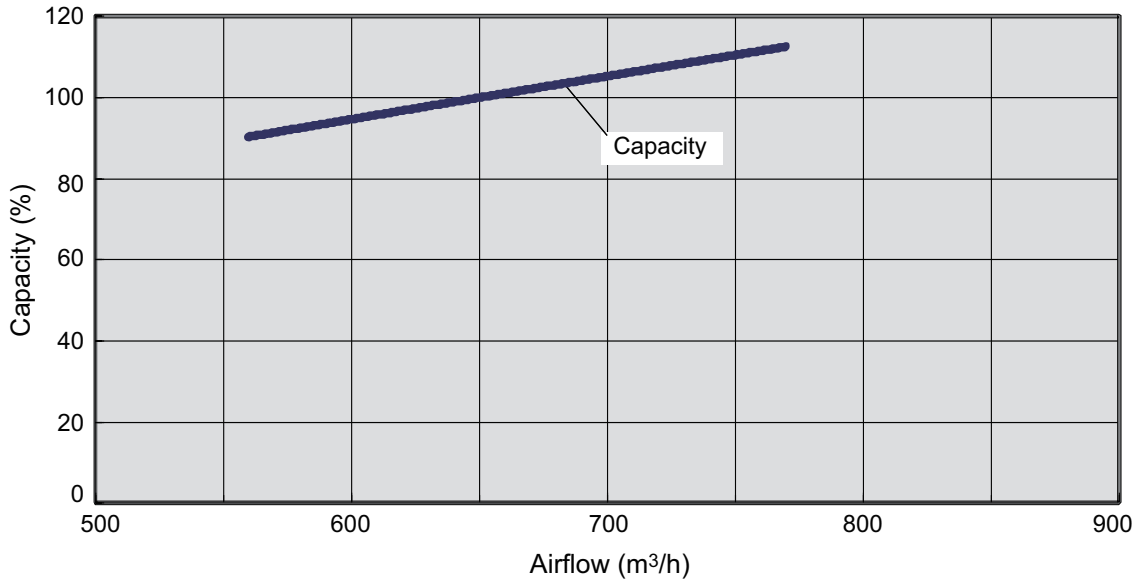

Model: ARYG14LLTB

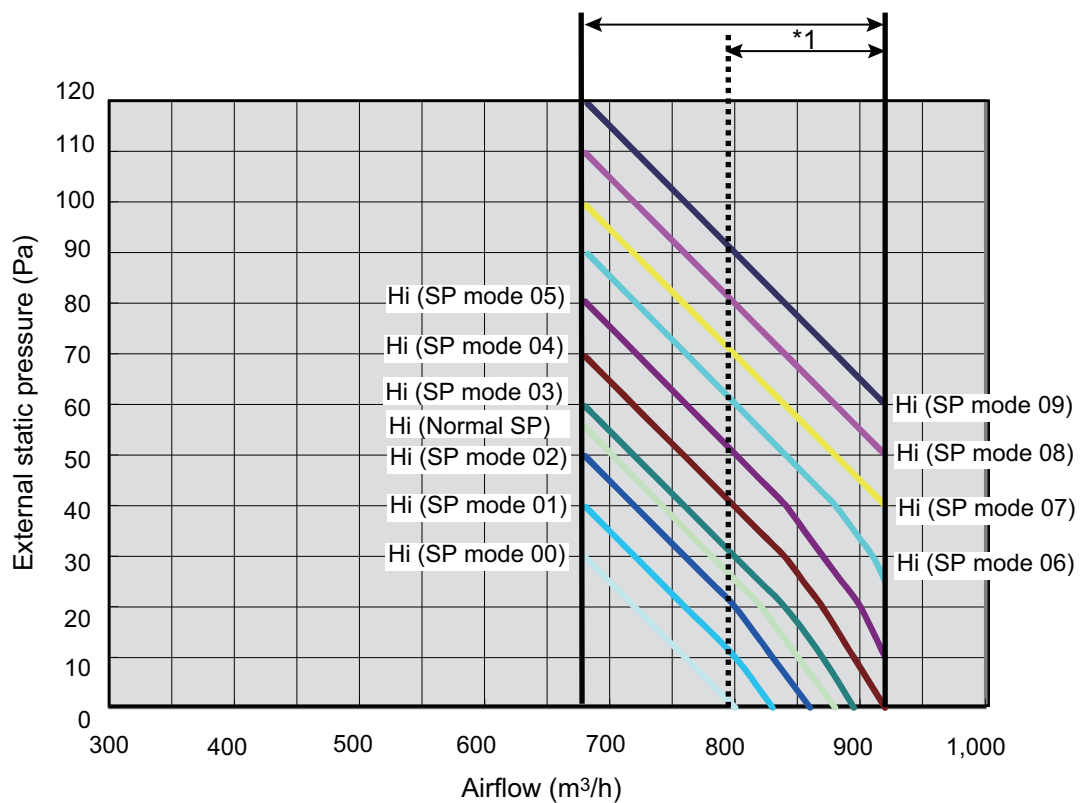
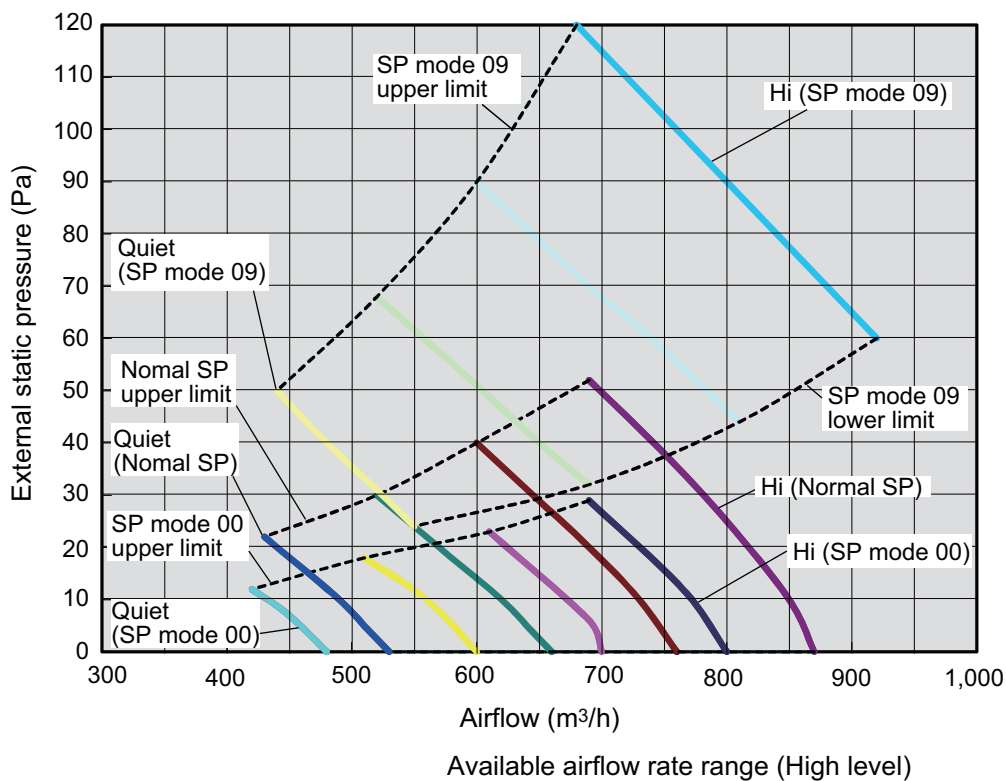

*1: Available airflow rate range when Auto louver grille (option) is installed.
 Fan speed: HIGH
 Vertical airflow direction louver: Up

● Characteristics of air volume and capacity

• Cooling

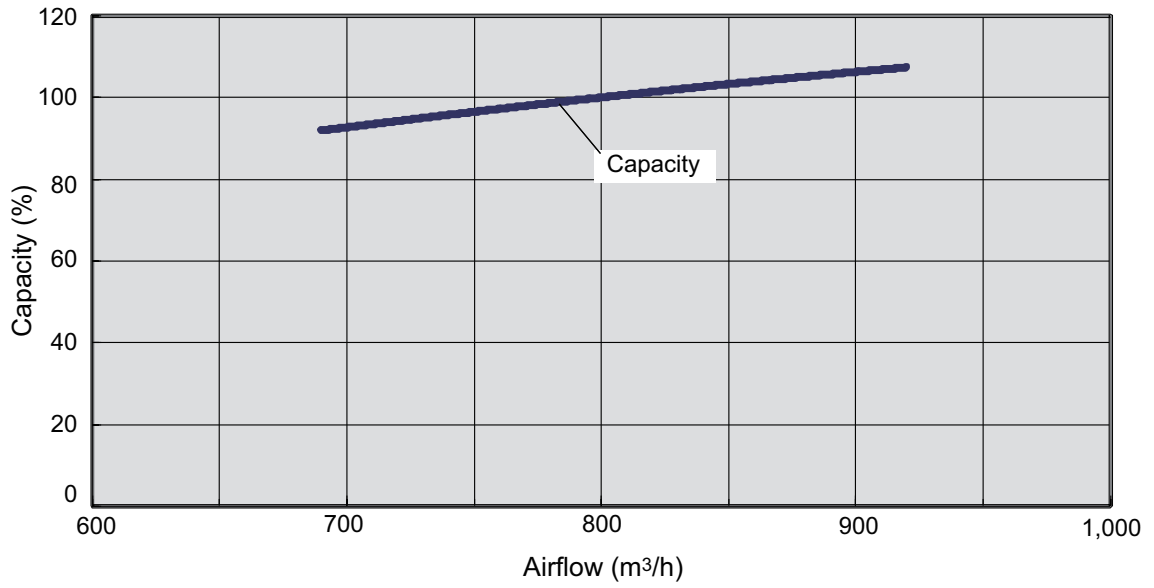

• Heating

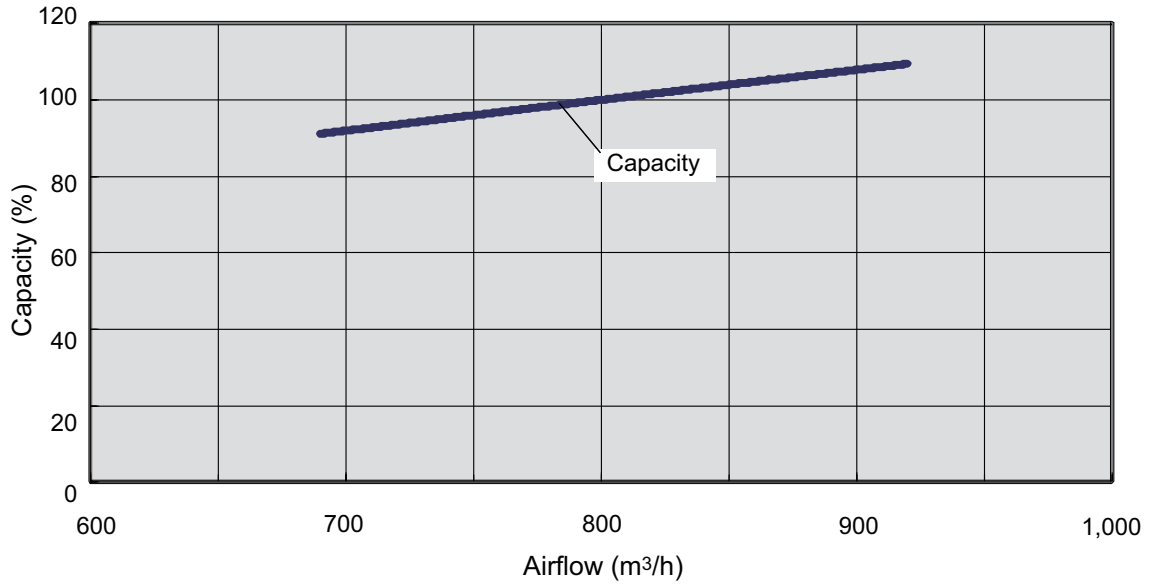

Model: ARYG18LLTB

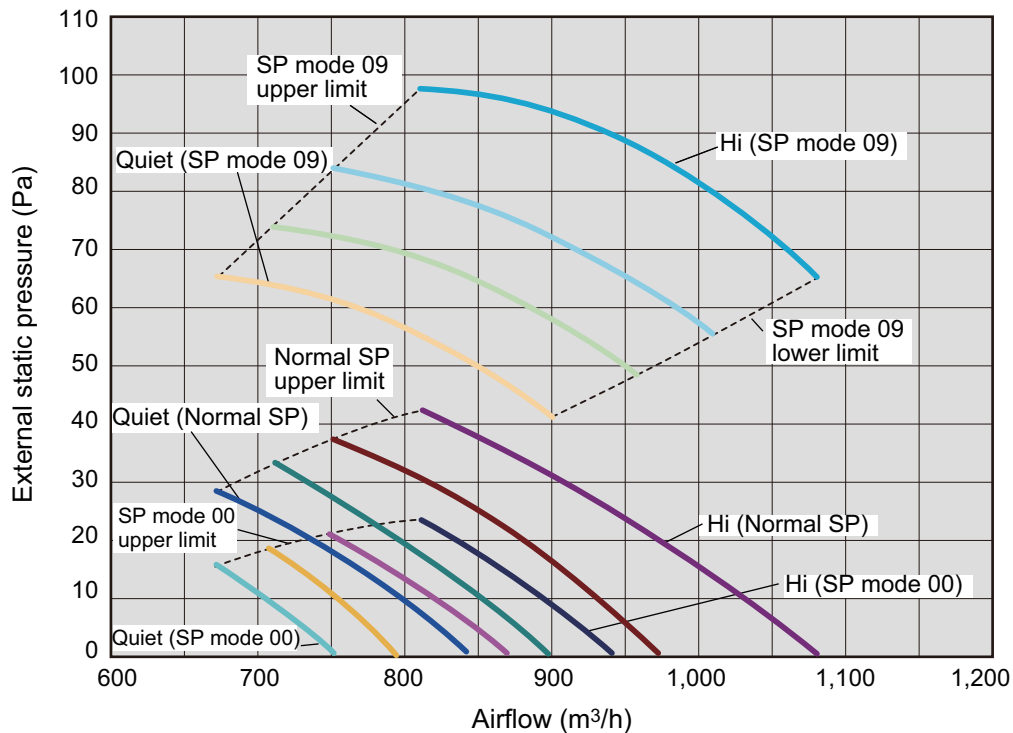

Available airflow rate range (High level)

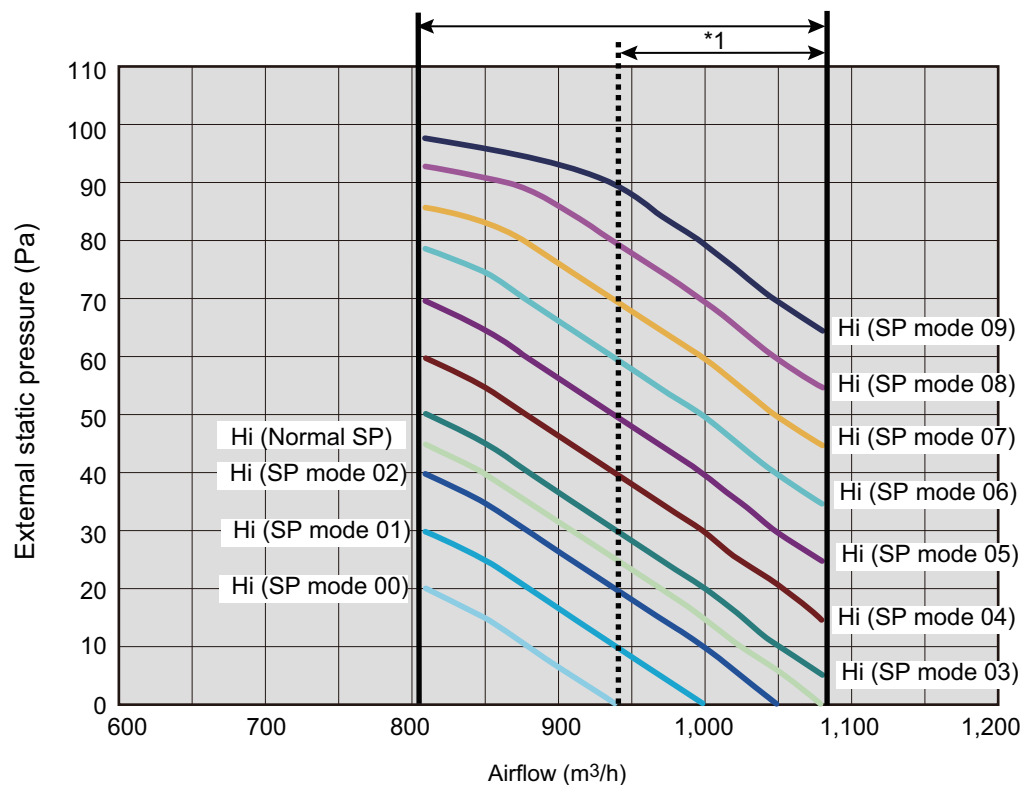

*1: Available airflow rate range when Auto louver grille (option) is installed.
 Fan speed: HIGH
 Vertical airflow direction louver: Up

● Characteristics of air volume and capacity

• Cooling

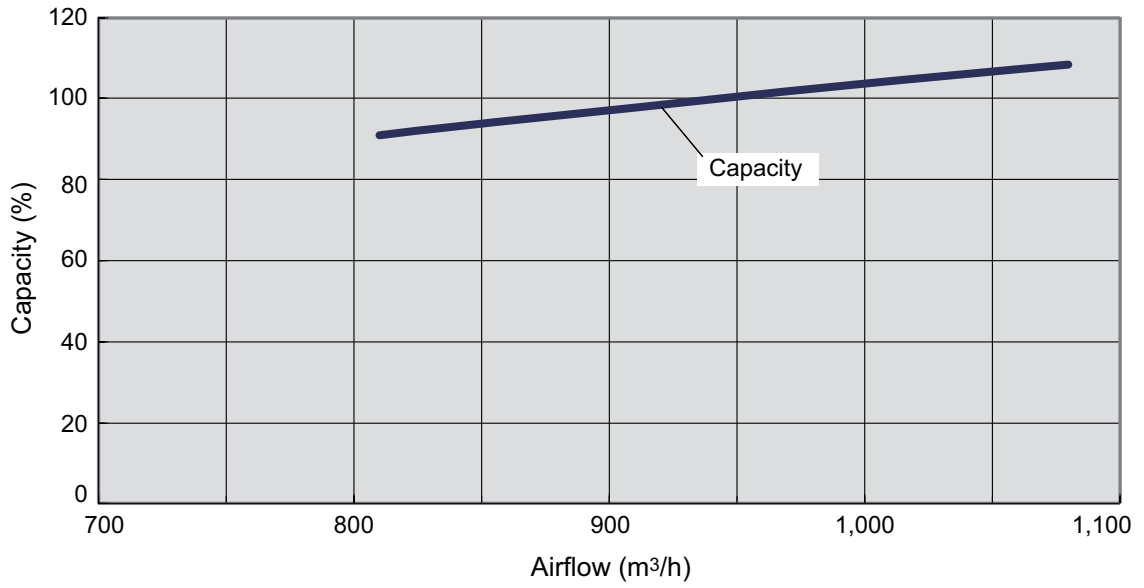

• Heating

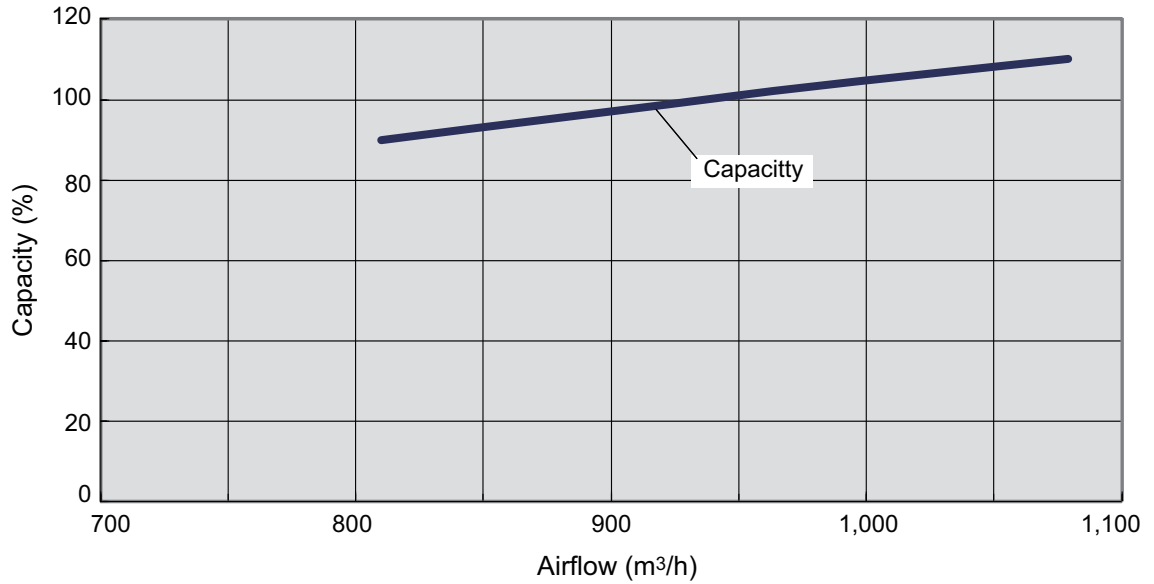

7. Airflow

Conversion factor:

- $1 \text{ m}^3/\text{h} = 0.2778 \text{ l/s} = 0.5886 \text{ CFM}$
- $3.6 \text{ m}^3/\text{h} = 1 \text{ l/s}$
- $1.699 \text{ m}^3/\text{h} = 1 \text{ CFM}$

7-1. Compact cassette type

Model	Operation mode	Fan speed	Airflow		
			m ³ /h	l/s	CFM
AUYG07LVLA AUYG09LVLA	Cooling	High	540	150	318
		Med	490	136	288
		Low	440	122	259
		Quiet	390	108	230
	Heating	High	540	150	318
		Med	490	136	288
		Low	440	122	259
		Quiet	390	108	230
AUYG12LVLB	Cooling	High	610	169	359
		Med	530	147	312
		Low	470	131	277
		Quiet	410	114	241
	Heating	High	610	169	359
		Med	530	147	312
		Low	470	131	277
		Quiet	410	114	241
AUYG14LVLB	Cooling	High	680	189	400
		Med	580	161	341
		Low	490	136	288
		Quiet	410	114	241
	Heating	High	700	194	412
		Med	620	172	365
		Low	550	153	324
		Quiet	430	119	253
AUYG18LVLB	Cooling	High	750	208	441
		Med	610	169	359
		Low	520	144	306
		Quiet	410	114	241
	Heating	High	800	222	471
		Med	710	197	418
		Low	600	167	353
		Quiet	450	125	265

7-2. Mini duct type

Model	Operation mode	Fan speed	Airflow		
			m ³ /h	l/s	CFM
ARYG07LSLAP	Cooling	High	550	153	324
		Med	440	122	259
		Low	390	108	230
		Quiet	360	100	212
	Heating	High	550	153	324
		Med	440	122	259
		Low	390	108	230
		Quiet	360	100	212
ARYG09LSLAP	Cooling	High	600	167	353
		Med	450	125	265
		Low	400	111	235
		Quiet	360	100	212
	Heating	High	600	167	353
		Med	450	125	265
		Low	400	111	235
		Quiet	360	100	212
ARYG12LSLAP	Cooling	High	650	181	383
		Med	490	136	288
		Low	430	119	253
		Quiet	360	100	212
	Heating	High	650	181	383
		Med	490	136	288
		Low	430	119	253
		Quiet	360	100	212
ARYG14LSLAP	Cooling	High	800	222	471
		Med	640	178	377
		Low	530	147	312
		Quiet	360	100	212
	Heating	High	800	222	471
		Med	640	178	377
		Low	530	147	312
		Quiet	360	100	212
ARYG18LSLAP	Cooling	High	940	261	553
		Med	750	208	441
		Low	540	150	318
		Quiet	480	133	282
	Heating	High	940	261	553
		Med	750	208	441
		Low	540	150	318
		Quiet	480	133	282

7-3. Slim duct type

Model	Operation mode	Fan speed	Airflow		
			m ³ /h	l/s	CFM
ARYG07LLTA	Cooling	High	550	153	324
		Med	490	136	288
		Low	470	131	277
		Quiet	440	122	259
	Heating	High	550	153	324
		Med	490	136	288
		Low	470	131	277
		Quiet	440	122	259
ARYG09LLTA	Cooling	High	600	167	353
		Med	550	153	324
		Low	500	139	294
		Quiet	450	125	265
	Heating	High	600	167	353
		Med	550	153	324
		Low	500	139	294
		Quiet	450	125	265
ARYG12LLTB	Cooling	High	650	181	383
		Med	600	167	353
		Low	550	153	324
		Quiet	480	133	283
	Heating	High	650	181	383
		Med	600	167	353
		Low	550	153	324
		Quiet	480	133	283
ARYG14LLTB	Cooling	High	800	222	471
		Med	700	194	412
		Low	600	167	353
		Quiet	480	133	283
	Heating	High	800	222	471
		Med	700	194	412
		Low	600	167	353
		Quiet	480	133	283
ARYG18LLTB	Cooling	High	940	261	553
		Med	880	244	518
		Low	820	227	483
		Quiet	750	208	441
	Heating	High	940	261	553
		Med	880	244	518
		Low	820	227	483
		Quiet	750	208	441

7-4. Wall mounted type

Model	Operation mode	Fan speed	Airflow		
			m ³ /h	l/s	CFM
ASYG07LUCA	Cooling	High	570	158	335
		Med	520	144	306
		Low	470	131	276
		Quiet	330	92	194
	Heating	High	570	158	335
		Med	520	144	306
		Low	470	131	276
		Quiet	330	92	194
ASYG09LUCA	Cooling	High	600	167	353
		Med	550	153	324
		Low	470	131	276
		Quiet	330	92	194
	Heating	High	600	167	353
		Med	550	153	324
		Low	470	131	276
		Quiet	330	92	194
ASYG12LUCA	Cooling	High	660	183	388
		Med	600	167	353
		Low	530	147	312
		Quiet	330	92	194
	Heating	High	660	183	388
		Med	600	167	353
		Low	530	147	312
		Quiet	330	92	194
ASYG14LUCA	Cooling	High	710	197	418
		Med	640	178	376
		Low	570	158	335
		Quiet	390	108	229
	Heating	High	710	197	418
		Med	640	178	376
		Low	590	164	347
		Quiet	430	119	253
ASYG07LMCA ASYG07LMCE	Cooling	High	560	156	330
		Med	500	139	294
		Low	430	119	253
		Quiet	310	86	182
	Heating	High	560	156	330
		Med	500	139	294
		Low	430	119	253
		Quiet	330	92	194
ASYG09LMCA ASYG09LMCE	Cooling	High	600	167	353
		Med	520	144	306
		Low	430	119	253
		Quiet	310	86	182
	Heating	High	600	167	353
		Med	520	144	306
		Low	430	119	253
		Quiet	330	92	194

Model	Operation mode	Fan speed	Airflow		
			m ³ /h	l/s	CFM
ASYG12LMCA ASYG12LMCE	Cooling	High	660	183	388
		Med	560	156	330
		Low	450	125	265
		Quiet	310	86	182
	Heating	High	660	183	388
		Med	560	156	330
		Low	470	131	277
		Quiet	330	92	194
ASYG14LMCA ASYG14LMCE	Cooling	High	730	203	430
		Med	600	167	353
		Low	530	147	312
		Quiet	360	100	212
	Heating	High	730	203	430
		Med	615	171	362
		Low	560	156	330
		Quiet	375	104	221
ASYG18LFCA	Cooling	High	900	250	530
		Med	740	206	436
		Low	620	172	365
		Quiet	550	153	324
	Heating	High	900	250	530
		Med	740	206	436
		Low	620	172	365
		Quiet	550	153	324
ASYG24LFCA ASYG24LFCC	Cooling	High	1,120	311	659
		Med	900	250	530
		Low	740	206	436
		Quiet	620	172	365
	Heating	High	1,100	306	647
		Med	900	250	530
		Low	740	206	436
		Quiet	620	172	365

7-5. Floor/Ceiling type

Model	Operation mode	Fan speed	Airflow		
			m ³ /h	l/s	CFM
ABYG14LVTA	Cooling	High	640	178	377
		Med	590	164	347
		Low	540	150	318
		Quiet	480	133	283
	Heating	High	640	178	377
		Med	590	164	347
		Low	540	150	318
		Quiet	480	133	283
ABYG18LVTB	Cooling	High	780	217	459
		Med	700	194	412
		Low	560	156	330
		Quiet	500	139	294
	Heating	High	780	217	459
		Med	700	194	412
		Low	560	156	330
		Quiet	500	139	294

7-6. Floor type

Model	Operation mode	Fan speed	Airflow		
			m ³ /h	l/s	CFM
AGYG09LVCA	Cooling	High	530	147	312
		Med	440	122	259
		Low	360	100	212
		Quiet	270	75	159
	Heating	High	530	147	312
		Med	460	128	270
		Low	380	106	224
		Quiet	270	75	159
AGYG12LVCA	Cooling	High	600	167	353
		Med	490	136	288
		Low	380	106	224
		Quiet	270	75	159
	Heating	High	600	167	353
		Med	510	142	300
		Low	410	114	241
		Quiet	270	75	159
AGYG14LVCA	Cooling	High	650	181	383
		Med	520	144	306
		Low	400	111	235
		Quiet	270	75	159
	Heating	High	650	181	383
		Med	540	150	318
		Low	430	119	253
		Quiet	270	75	159

8. Noise level curve

8-1. Compact cassette type

Model: AUYG07LVLA

Cooling

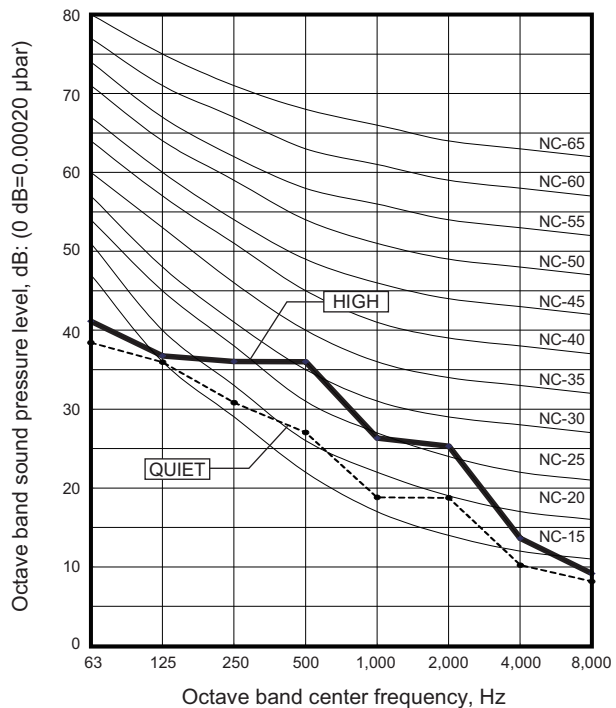

Heating

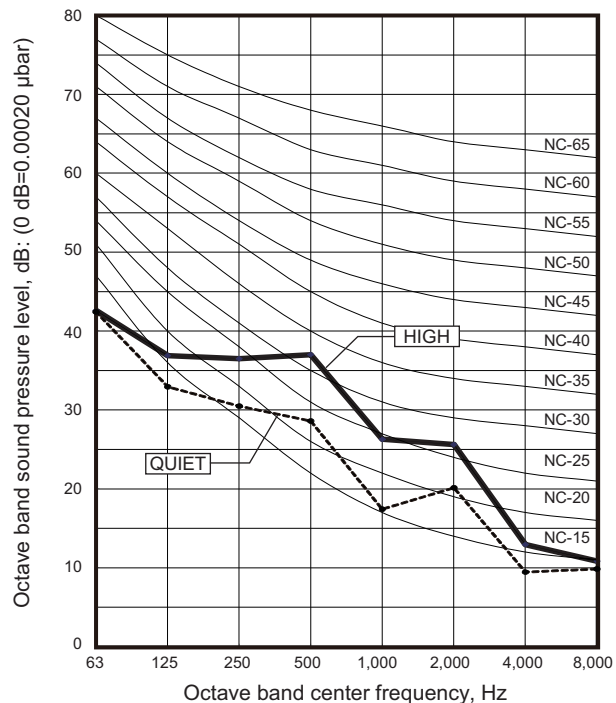

Model: AUYG09LVLA

Cooling

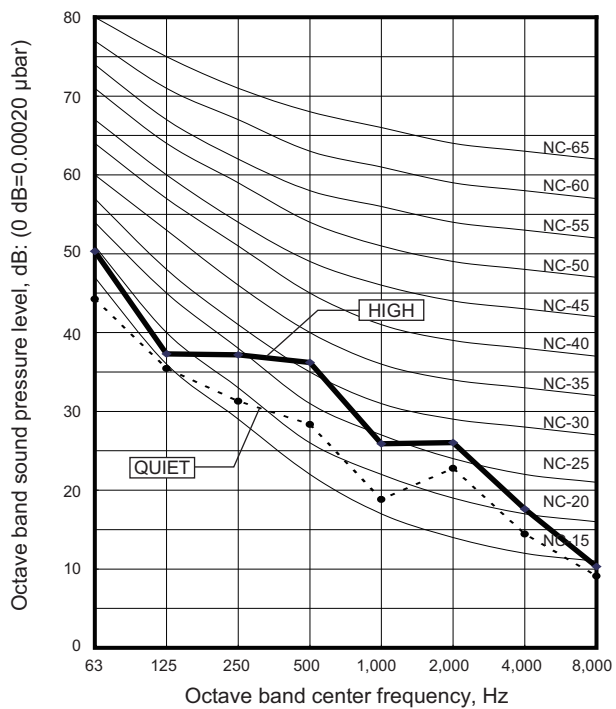

Heating

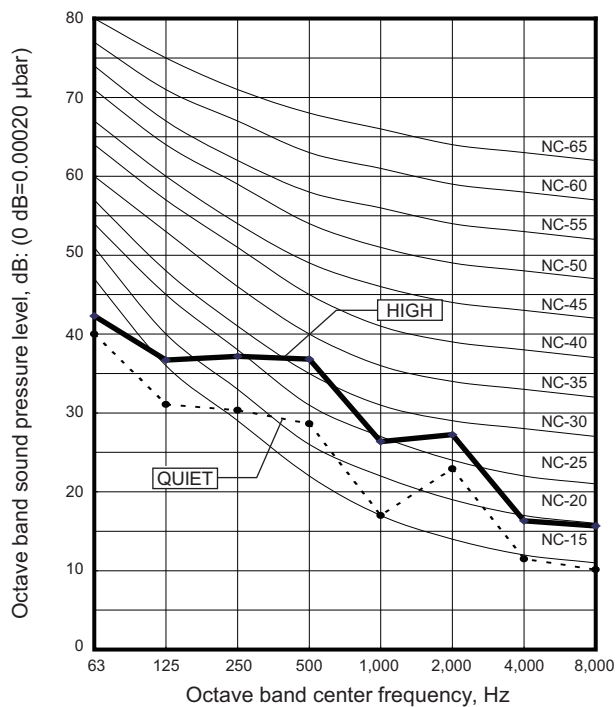

Model: AUYG12LVLB

Cooling

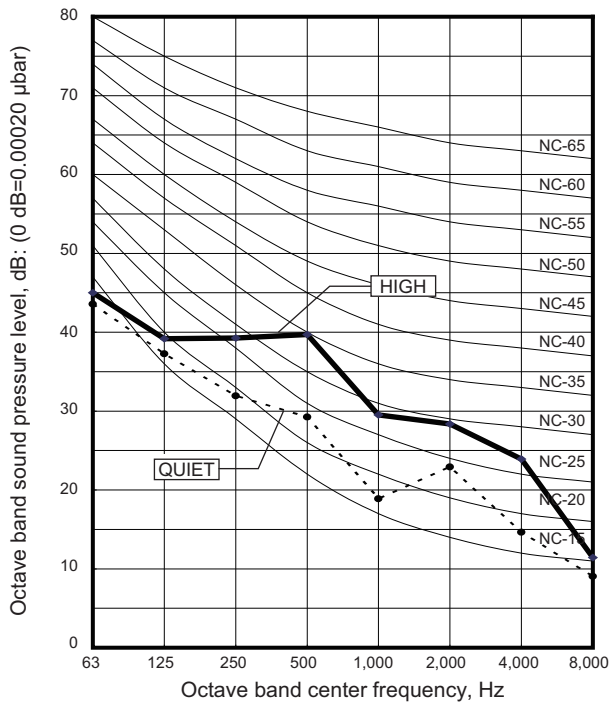

Heating

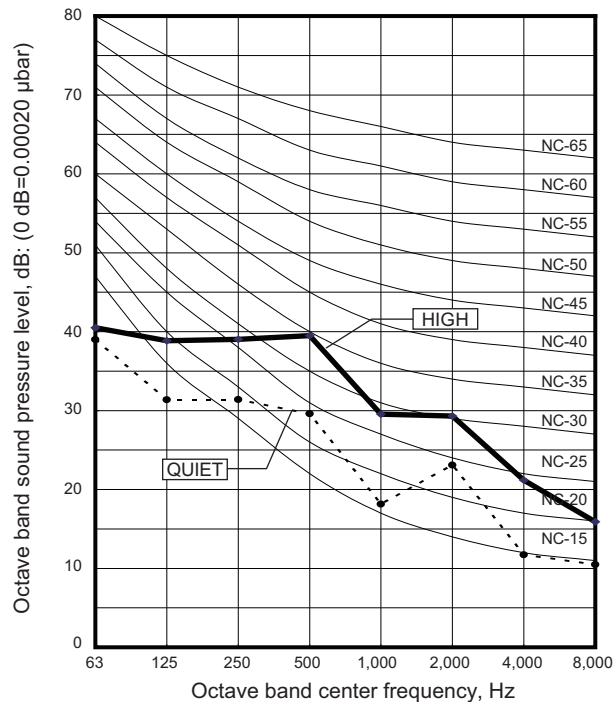

Model: AUYG14LVLB

Cooling

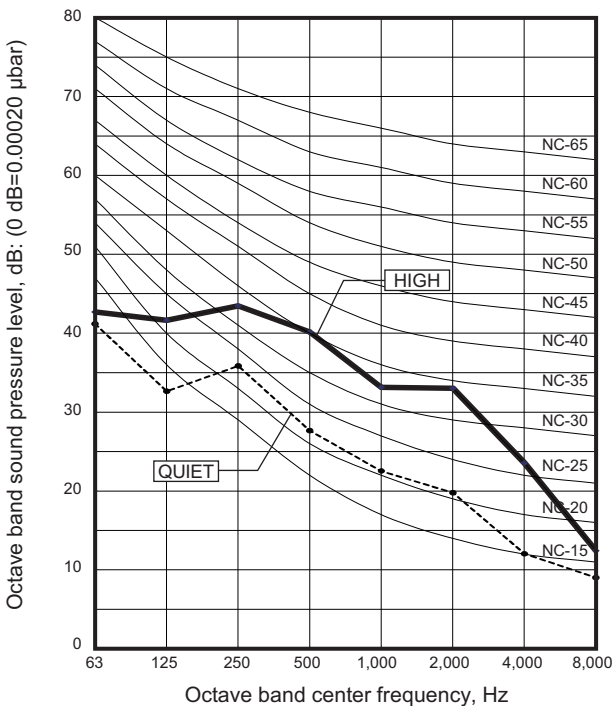

Heating

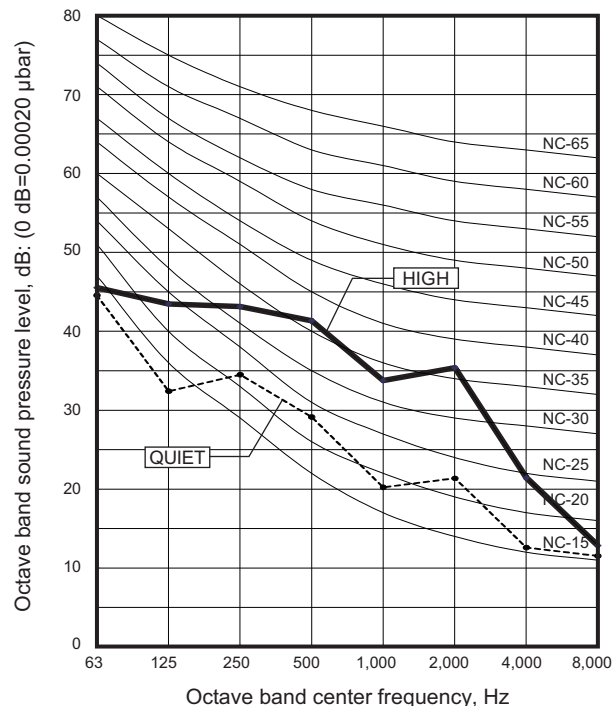

■ Model: AUYG18LVLB

● Cooling

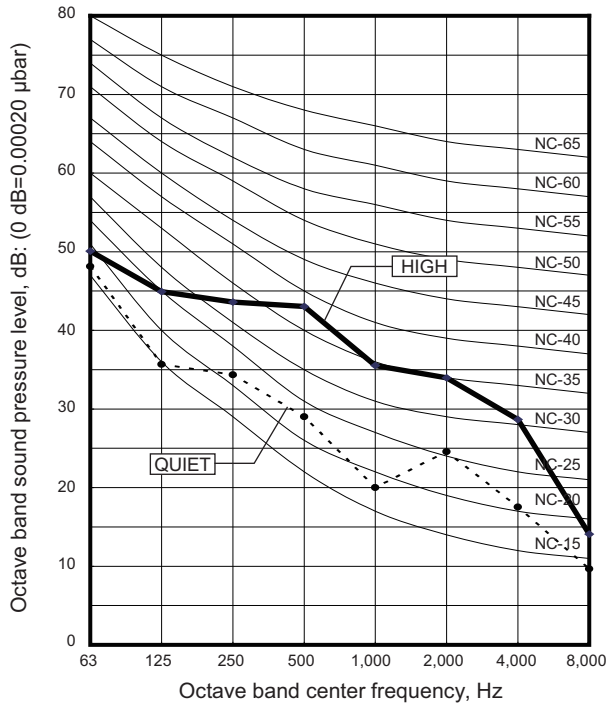

● Heating

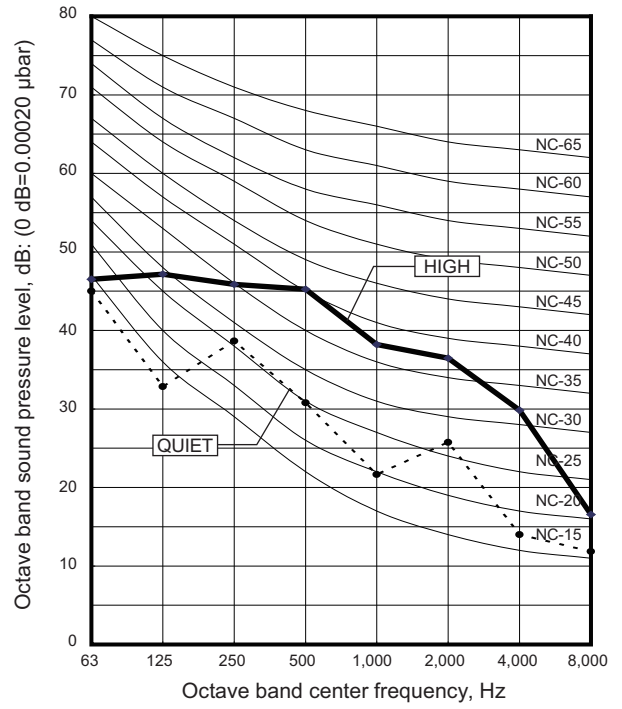

8-2. Mini duct type

Model: ARYG07LSLAP

● Cooling

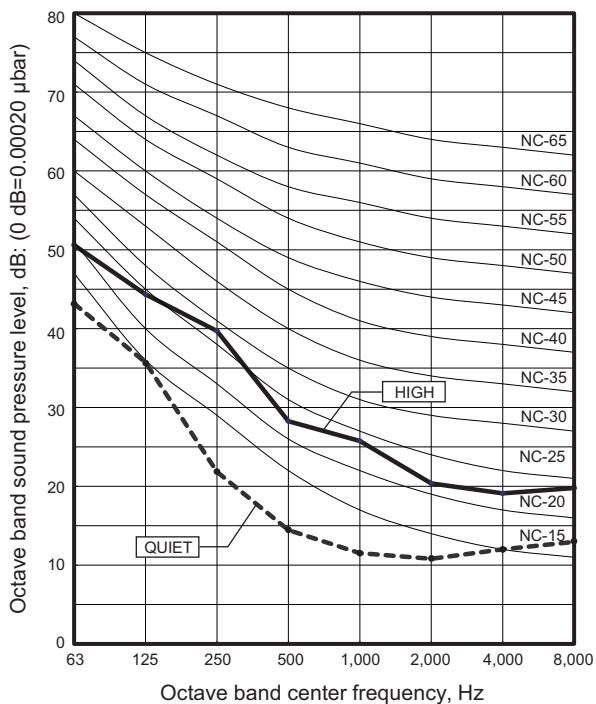

● Heating

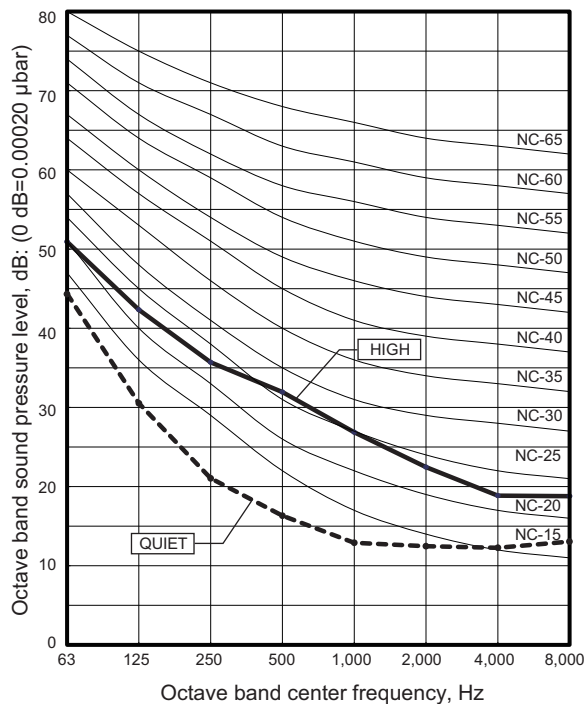

Model: ARYG09LSLAP

● Cooling

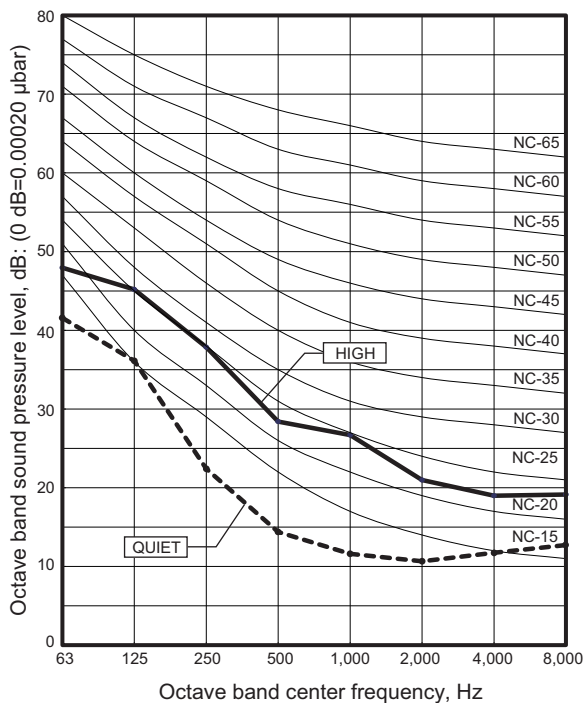

● Heating

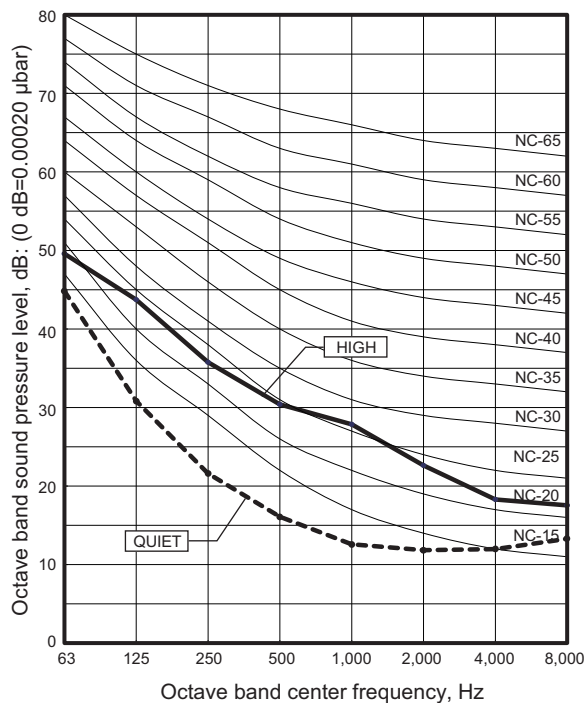

Model: ARYG12LSLAP

Cooling

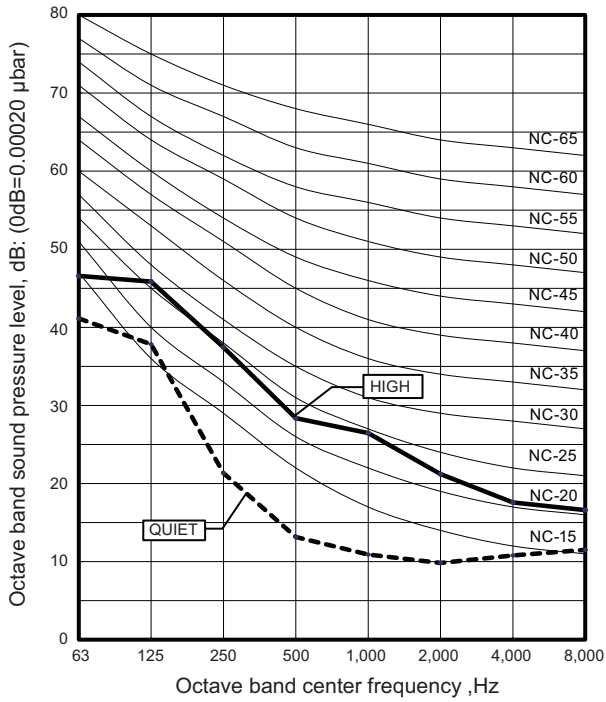

Heating

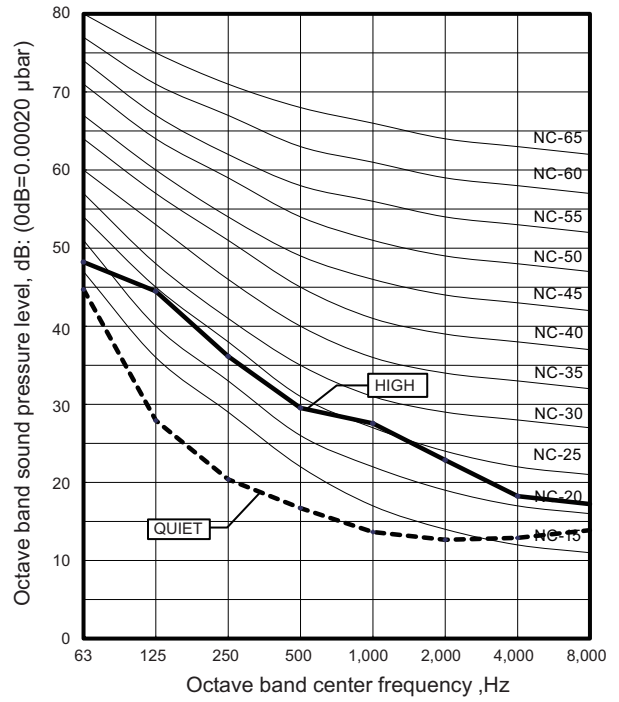

Model: ARYG14LSLAP

Cooling

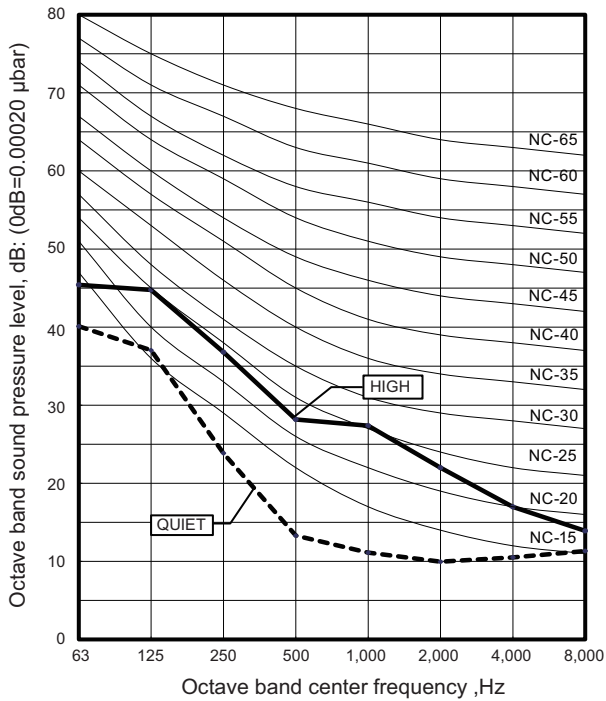

Heating

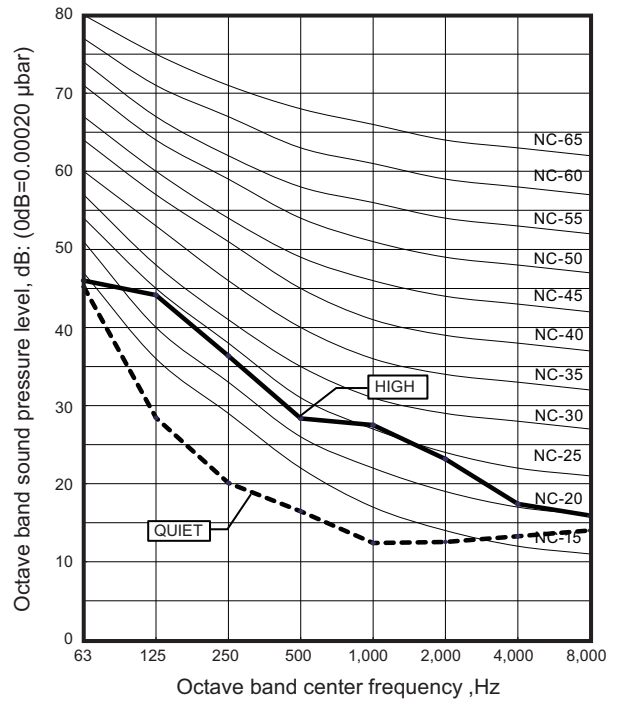

■ Model: ARYG18LSLAP

● Cooling

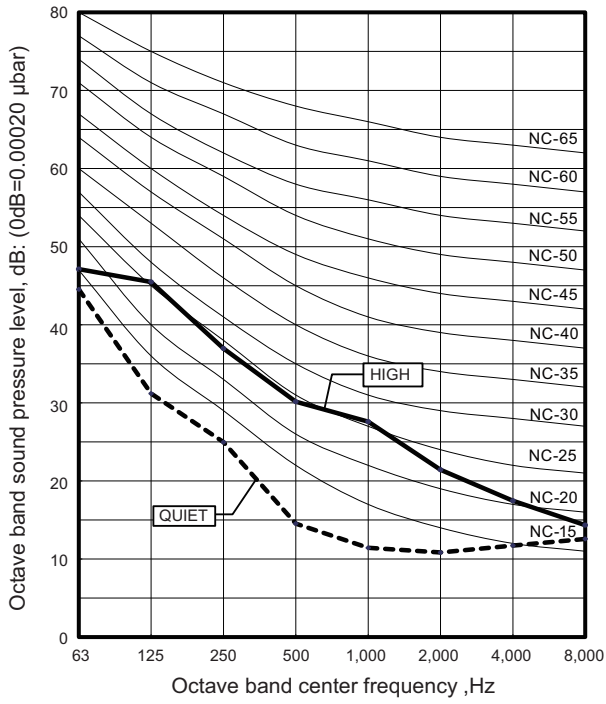

● Heating

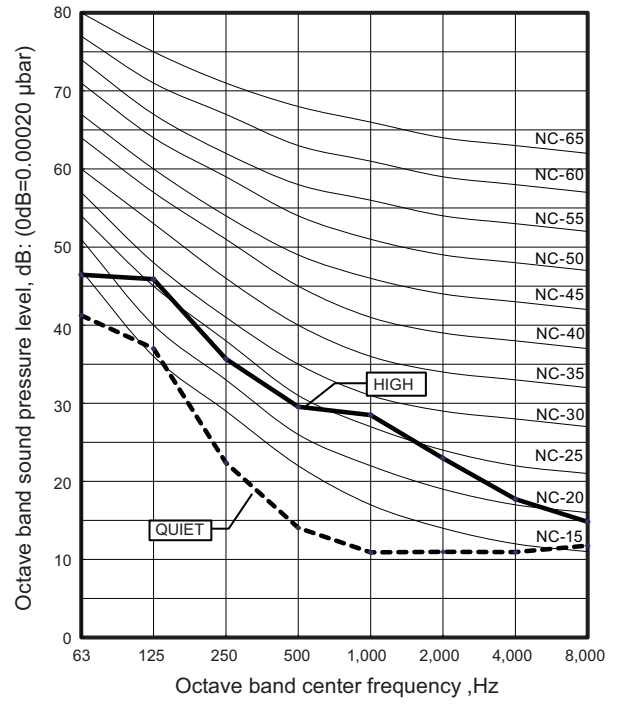

8-3. Slim duct type

Model: ARYG07LLTA

● Cooling

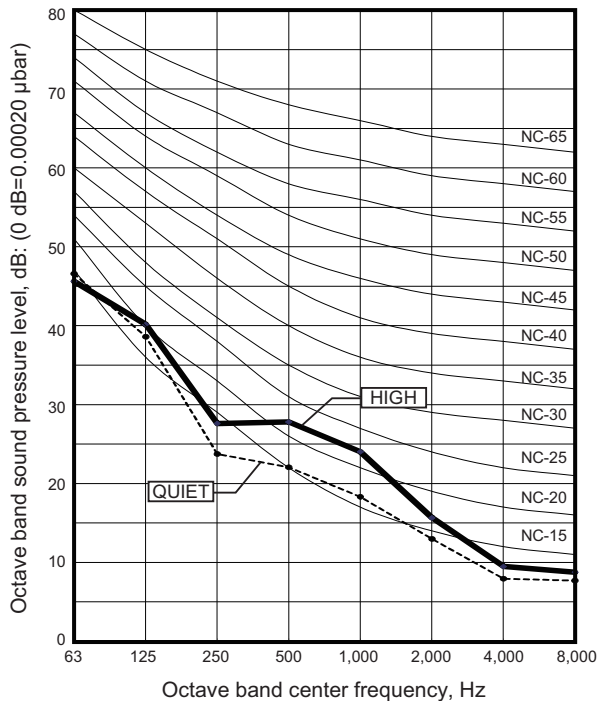

● Heating

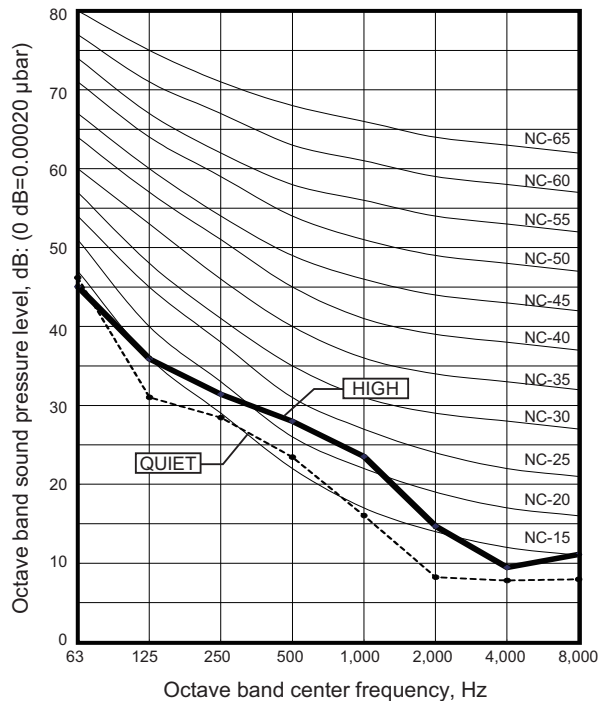

Model: ARYG09LLTA

● Cooling

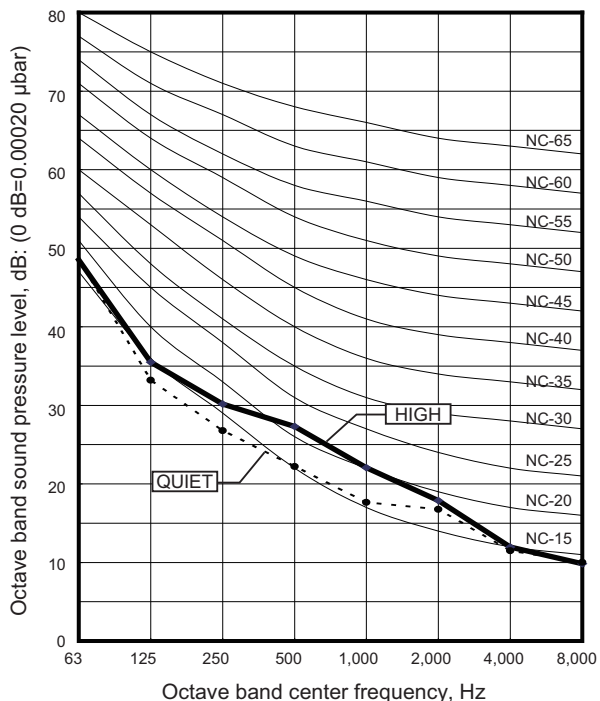

● Heating

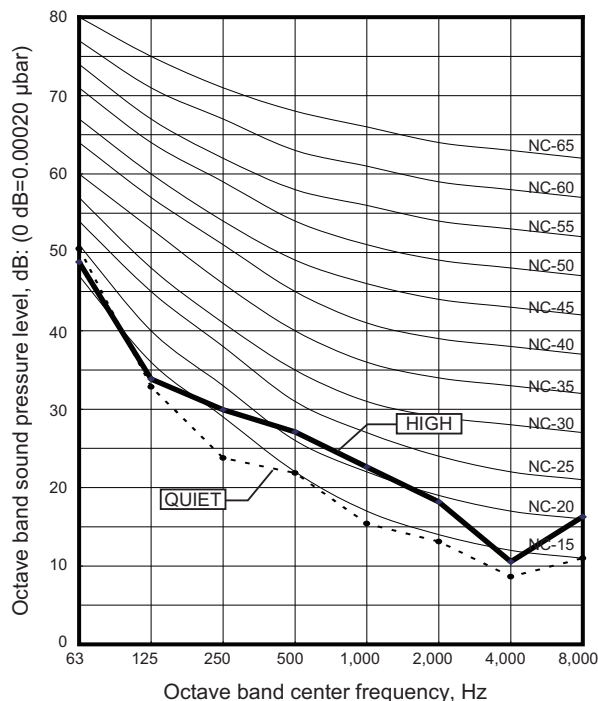

Model: ARYG12LLTB

Cooling

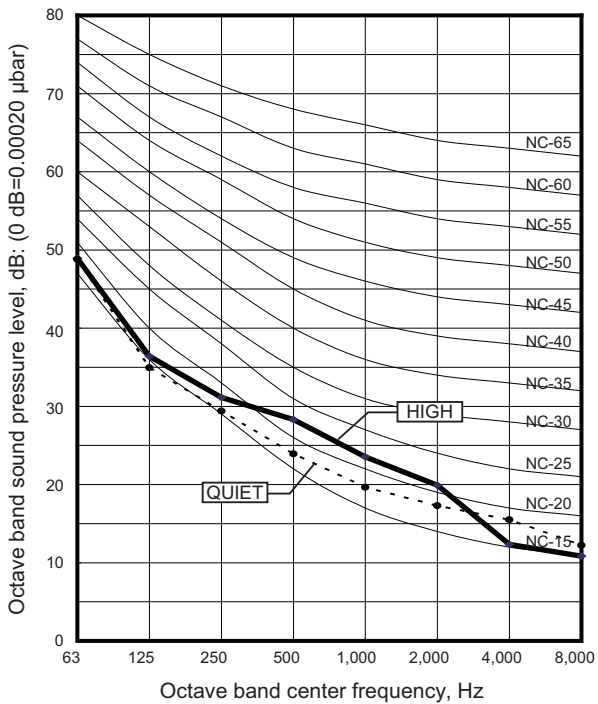

Heating

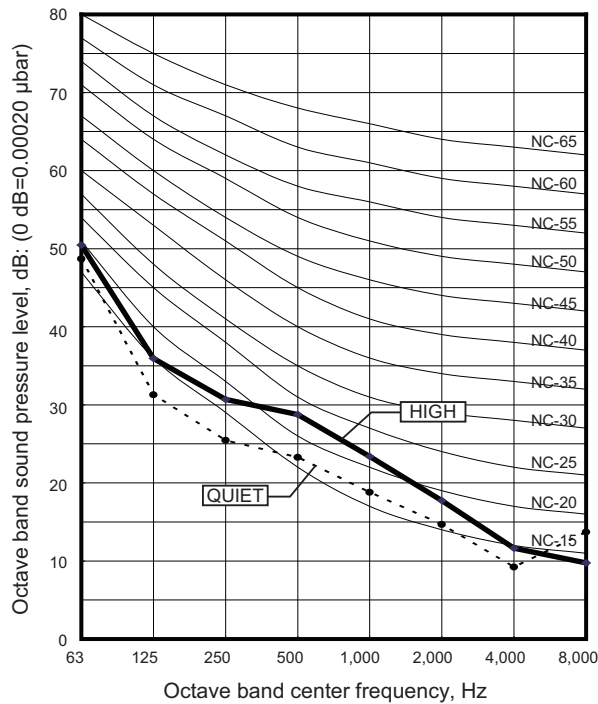

Model: ARYG14LLTB

Cooling

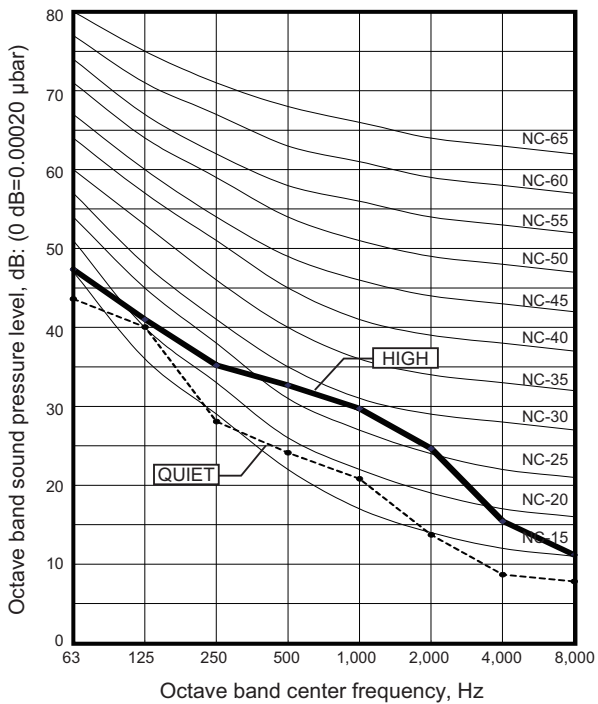

Heating

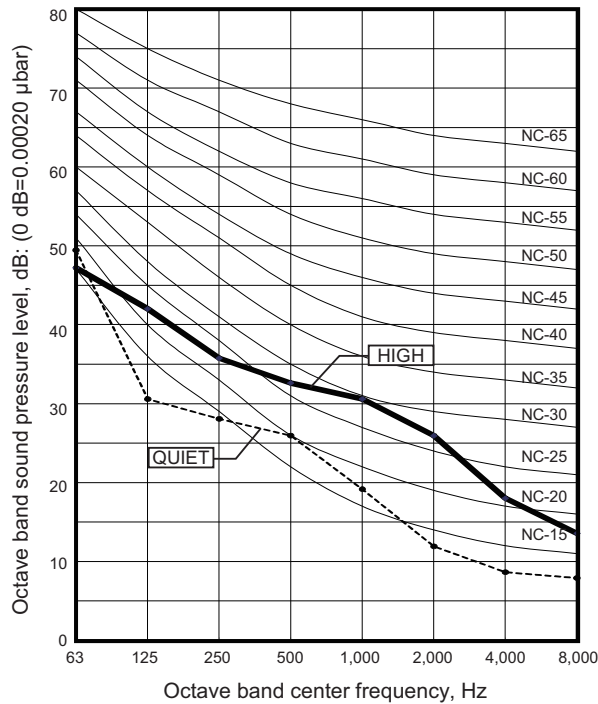

■ Model: ARYG18LLTB

● Cooling

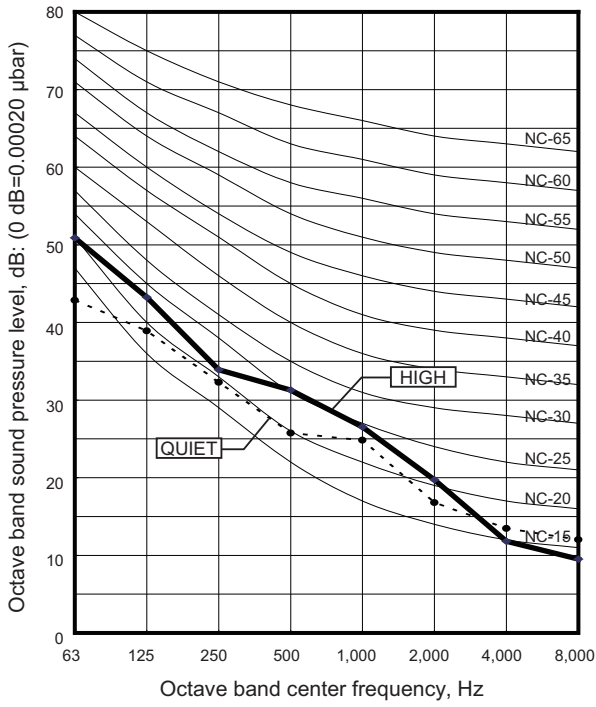

● Heating

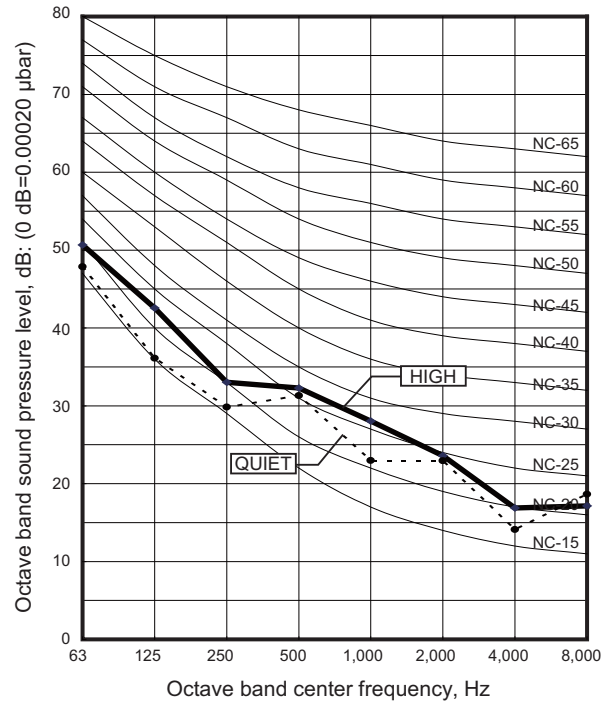

8-4. Wall mounted type

Model: ASYG07LUCA

● Cooling

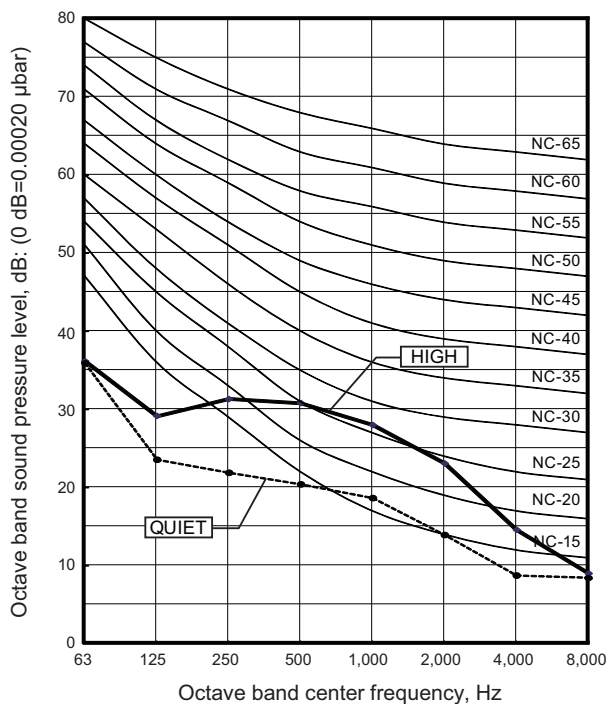

● Heating

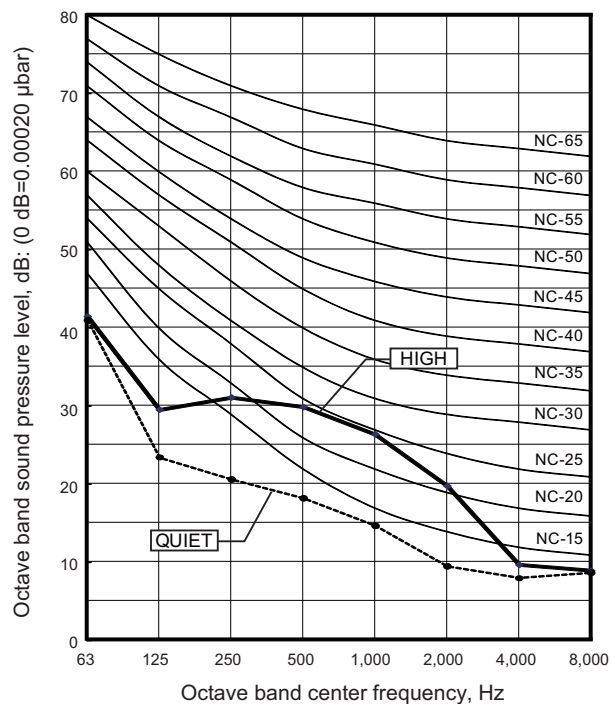

Model: ASYG09LUCA

● Cooling

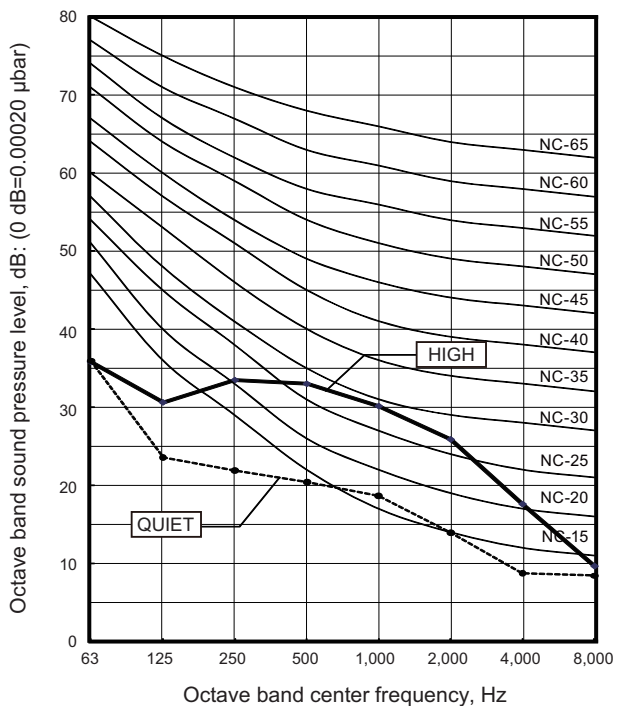

● Heating

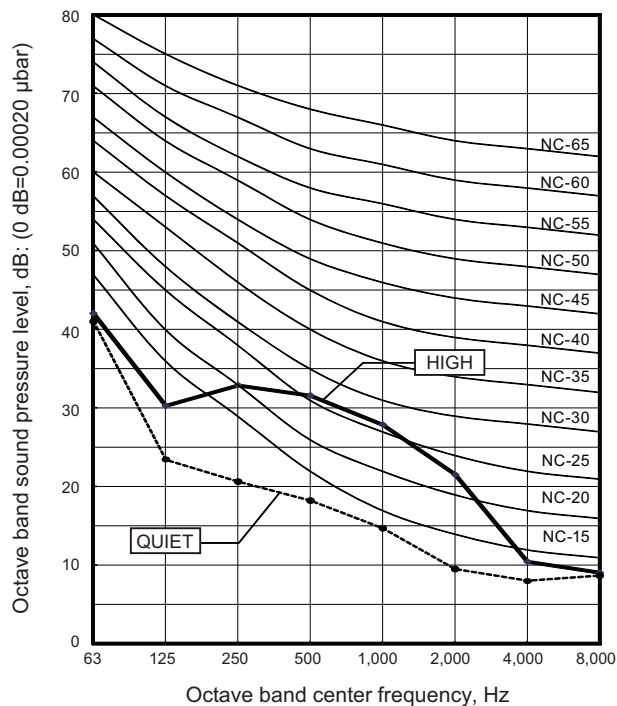

Model: ASYG12LUCA

Cooling

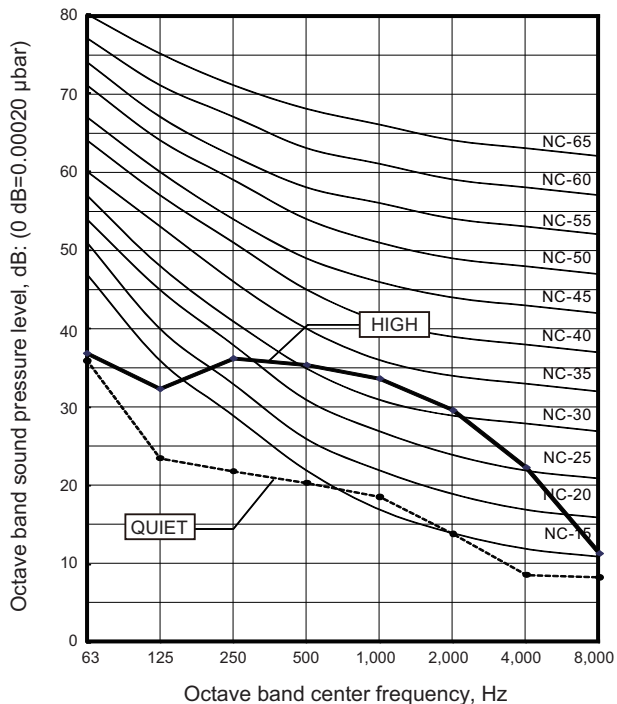

Heating

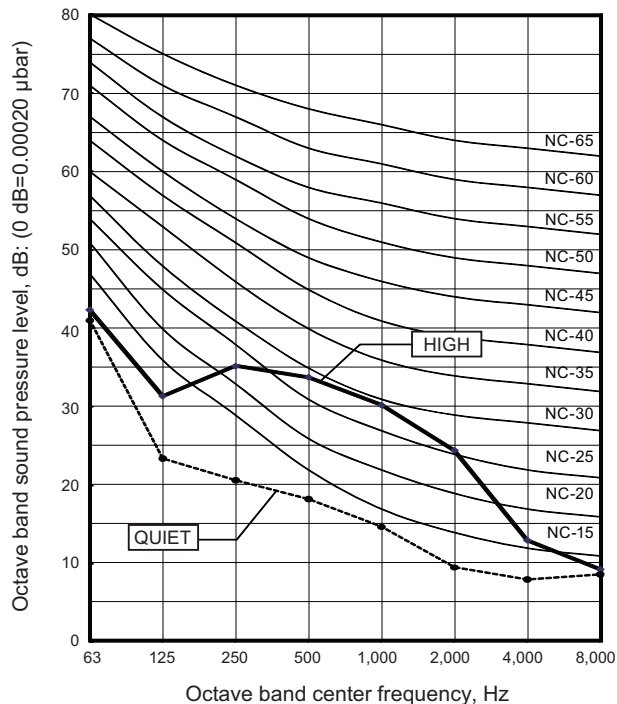

Model: ASYG14LUCA

Cooling

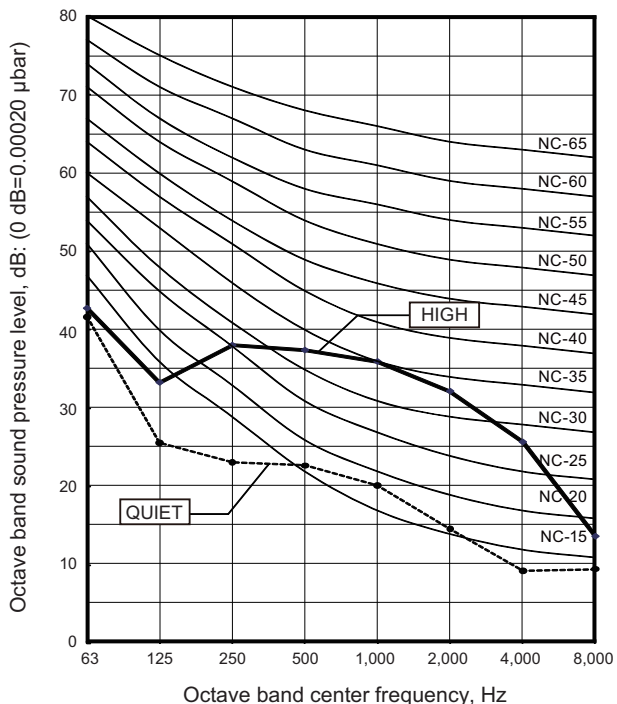

Heating

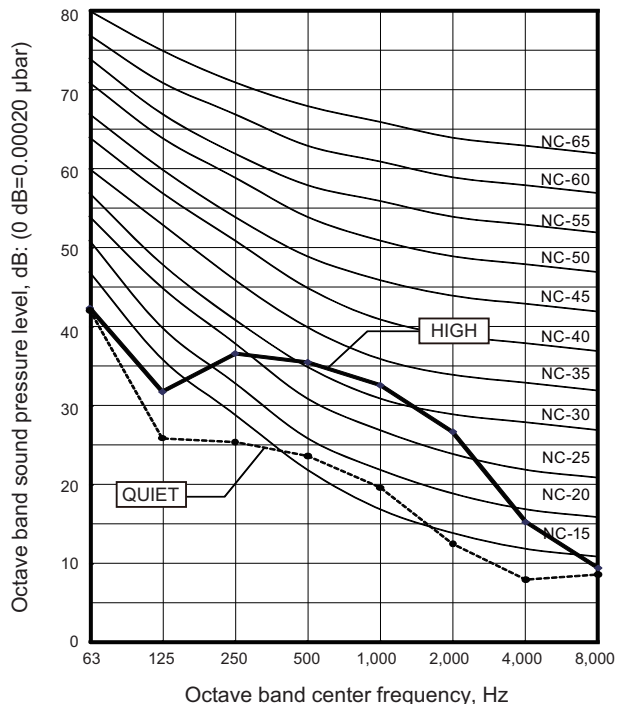

Models: ASYG07LMCA and ASYG07LMCE

Cooling

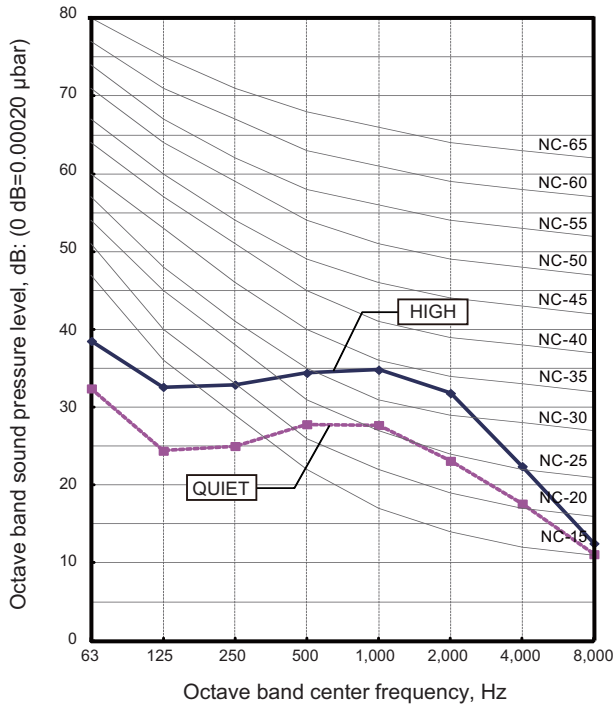

Heating

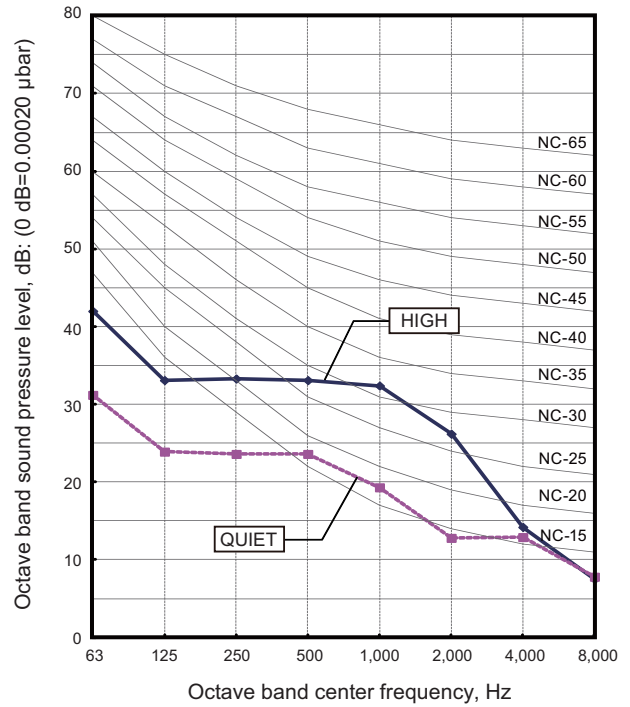

Models: ASYG09LMCA and ASYG09LMCE

Cooling

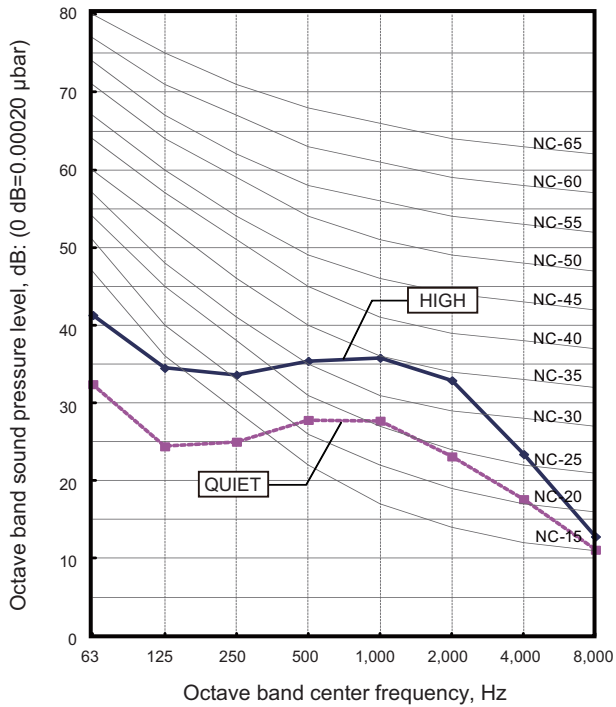

Heating

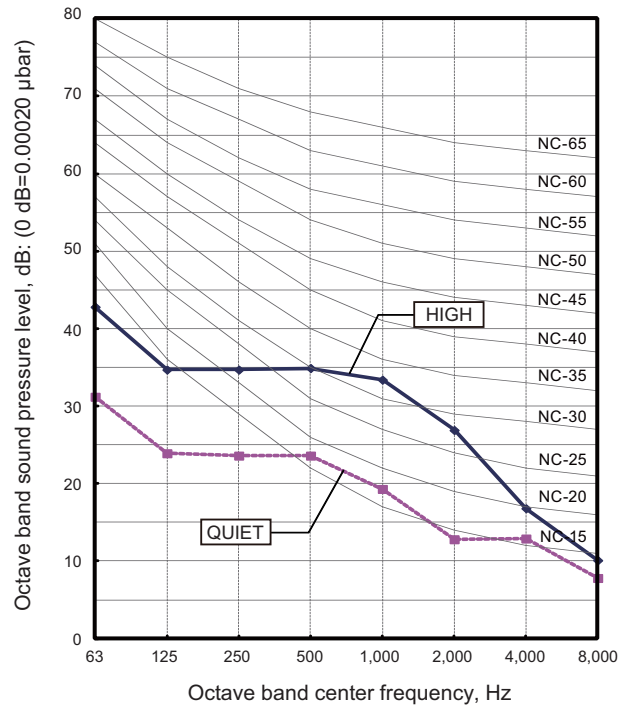

Models: ASYG12LMCA and ASYG12LMCE

Cooling

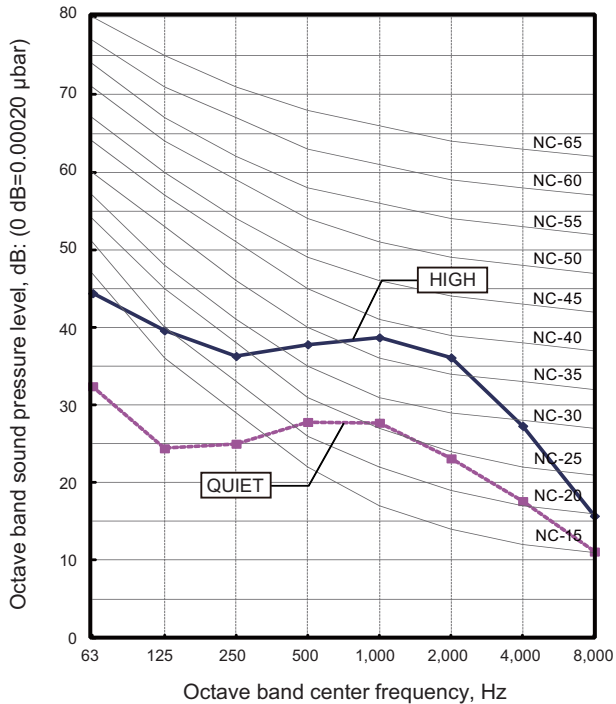

Heating

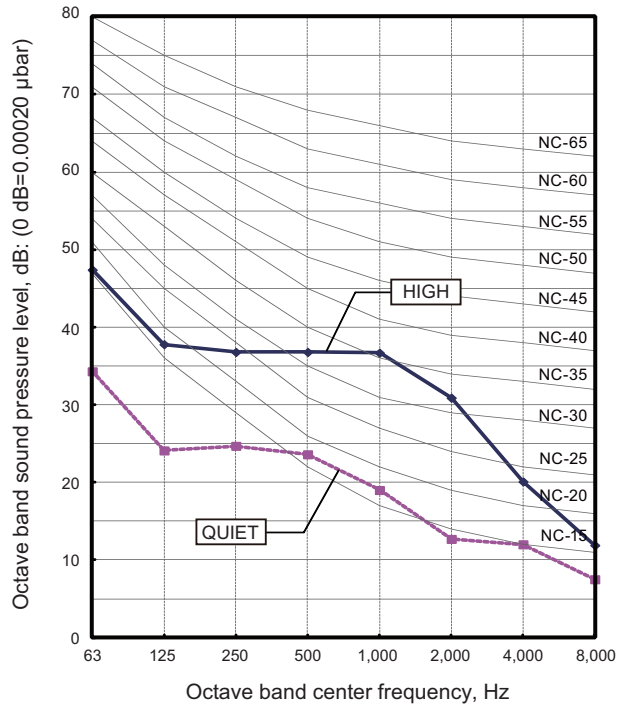

Models: ASYG14LMCA and ASYG14LMCE

Cooling

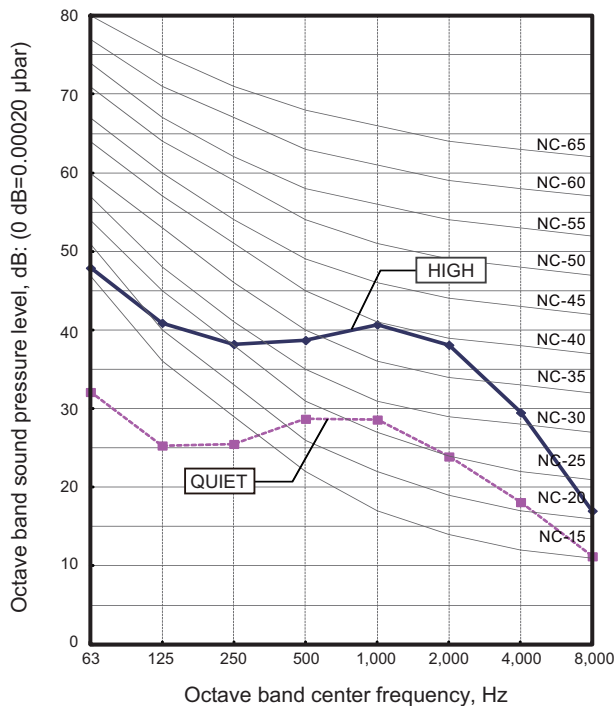

Heating

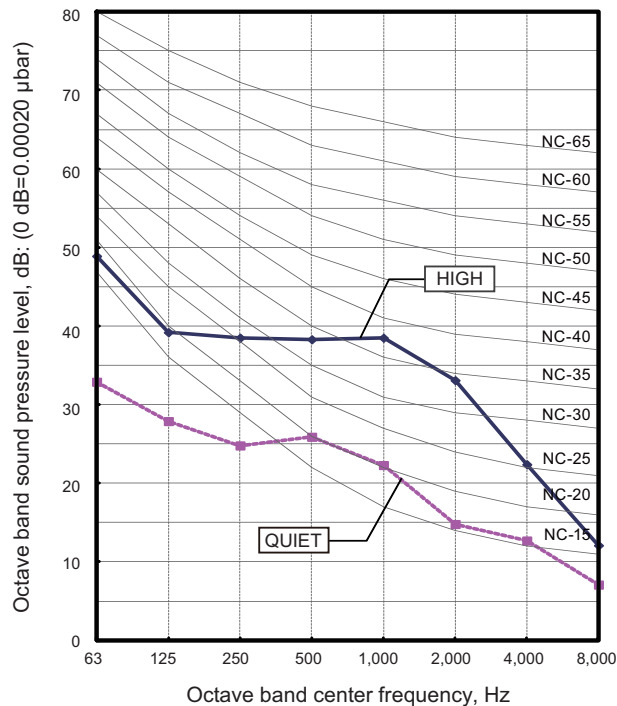

Model: ASYG18LFCA

Cooling

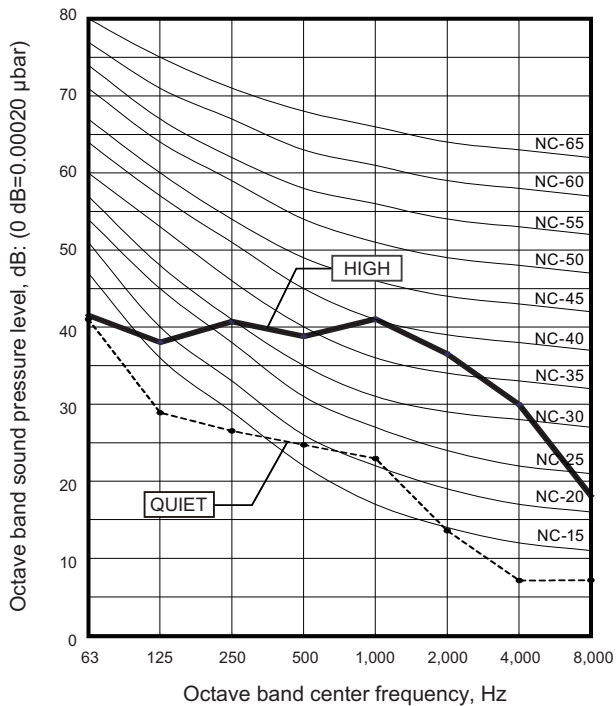

Heating

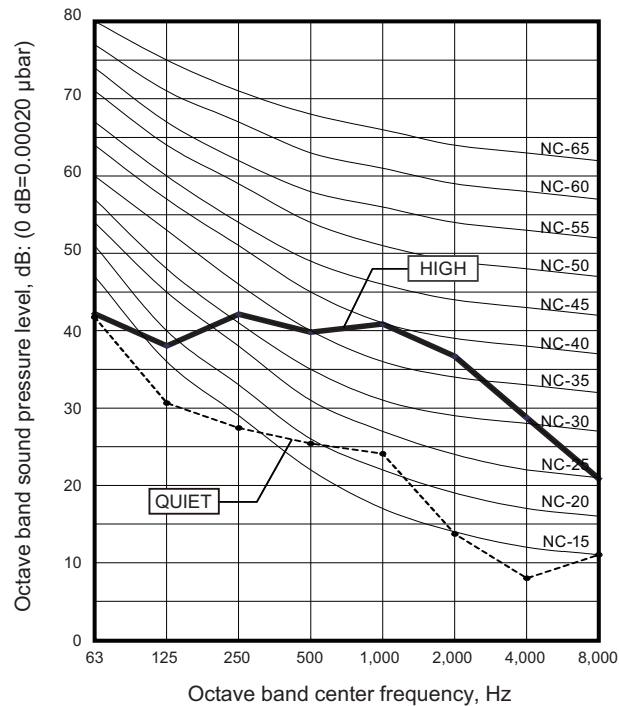

Models: ASYG24LFCA and ASYG24LFCC

Cooling

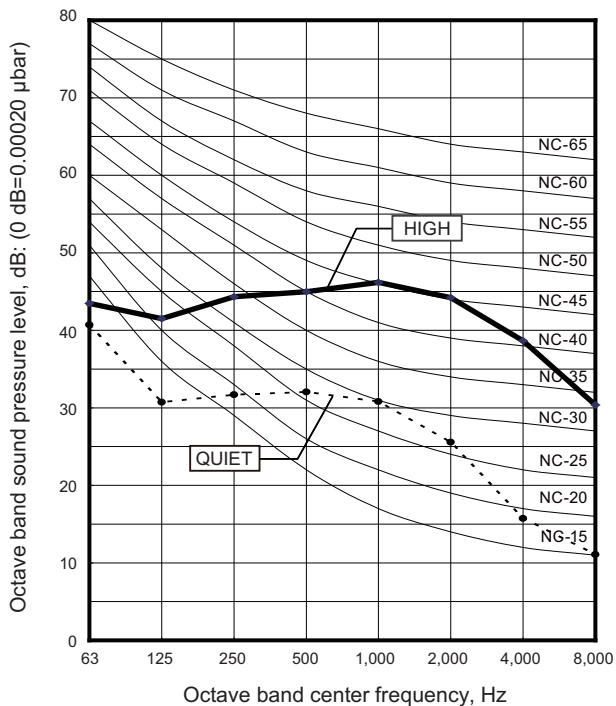

Heating

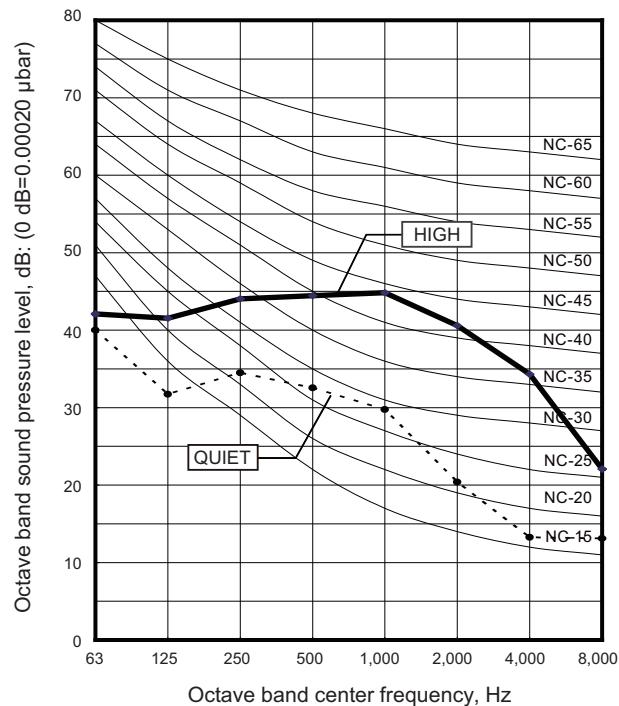

8-5. Floor/Ceiling type

Model: ABYG14LVTA

● Cooling

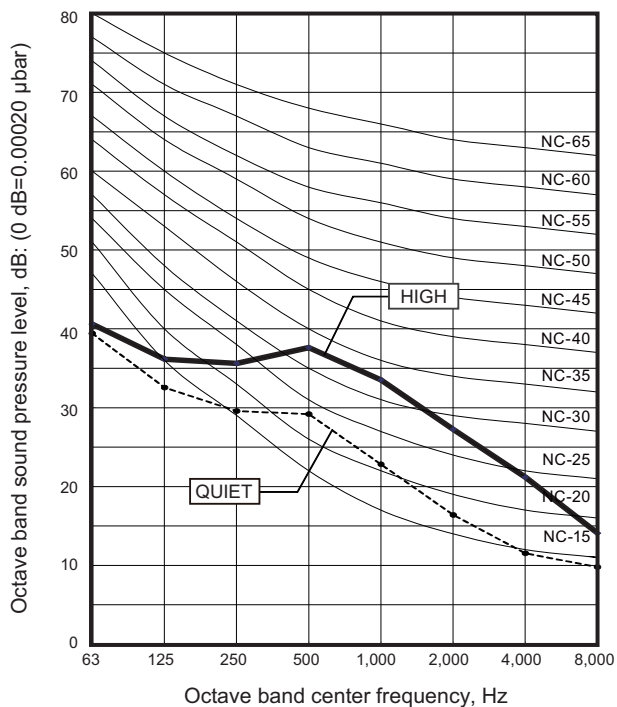

● Heating

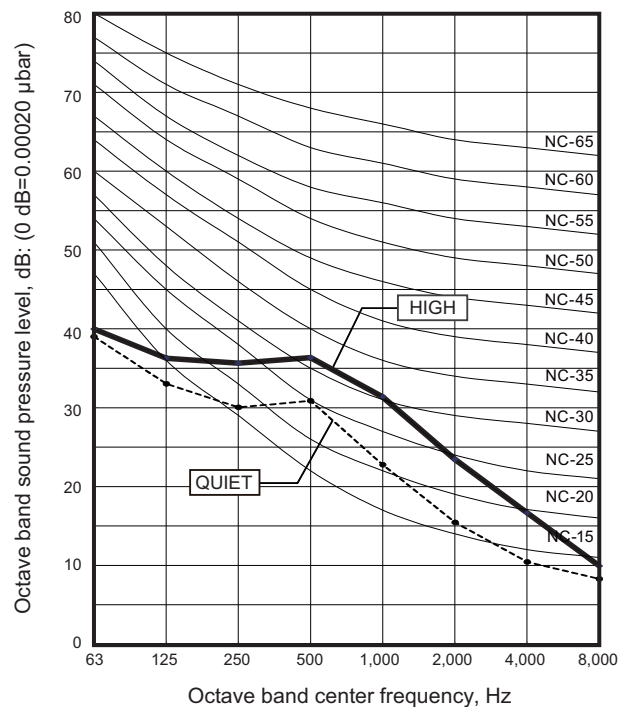

Model: ABYG18LVTB

● Cooling

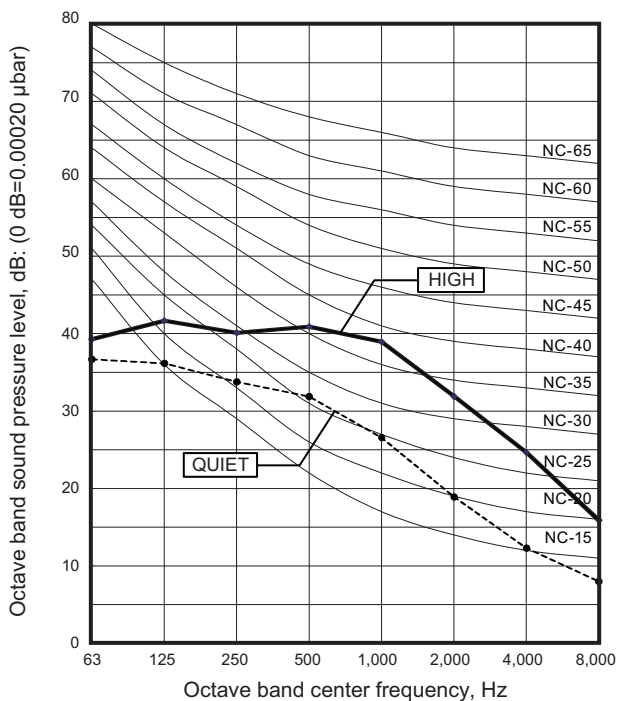

● Heating

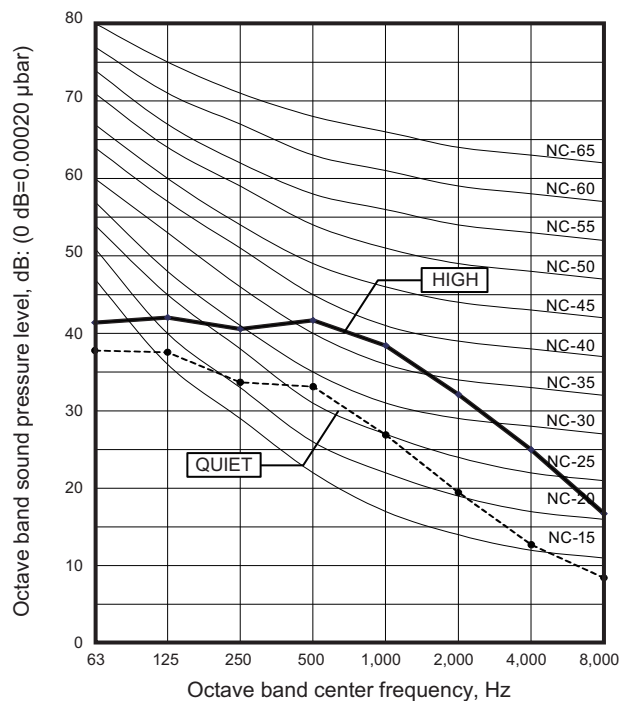

8-6. Floor type

Model: AGYG09LVCA

● Cooling

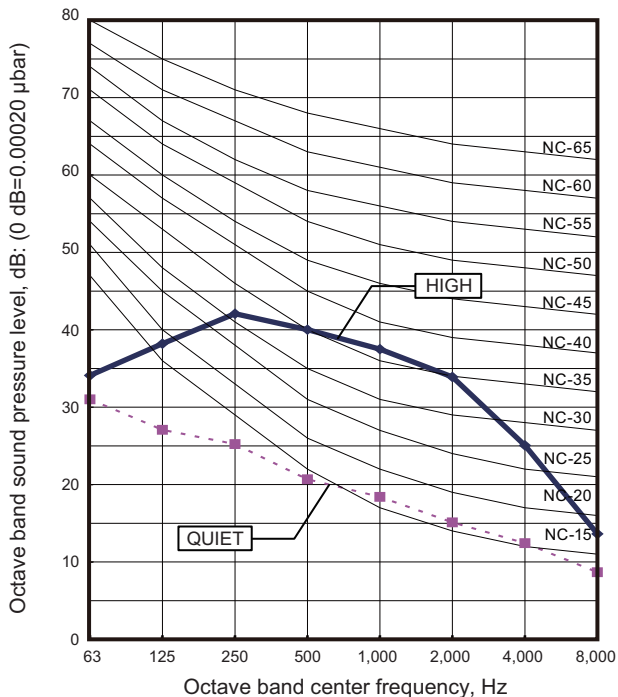

● Heating

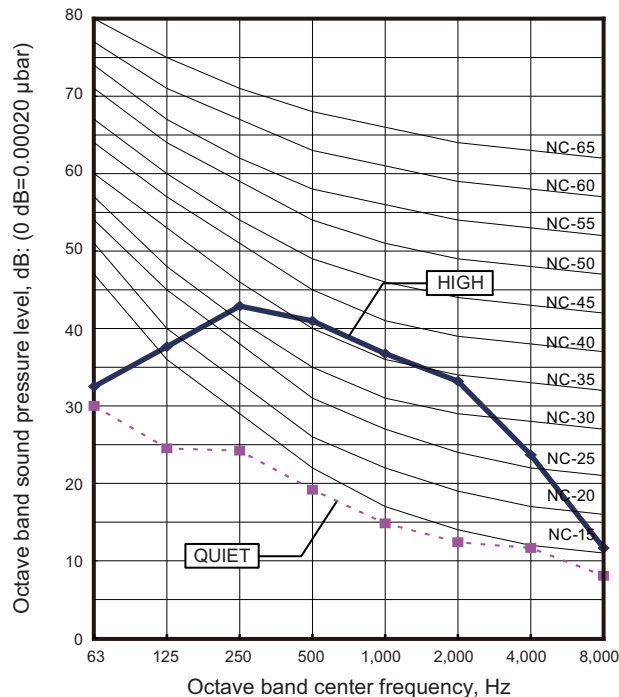

Model: AGYG12LVCA

● Cooling

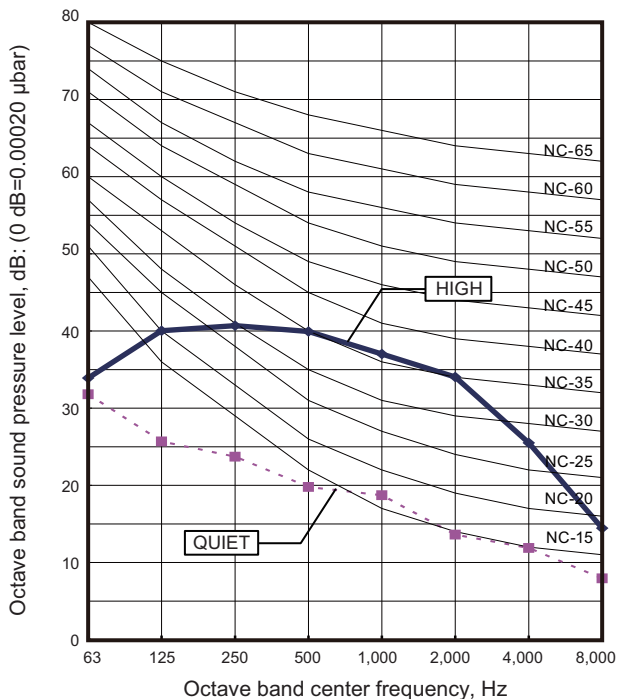

● Heating

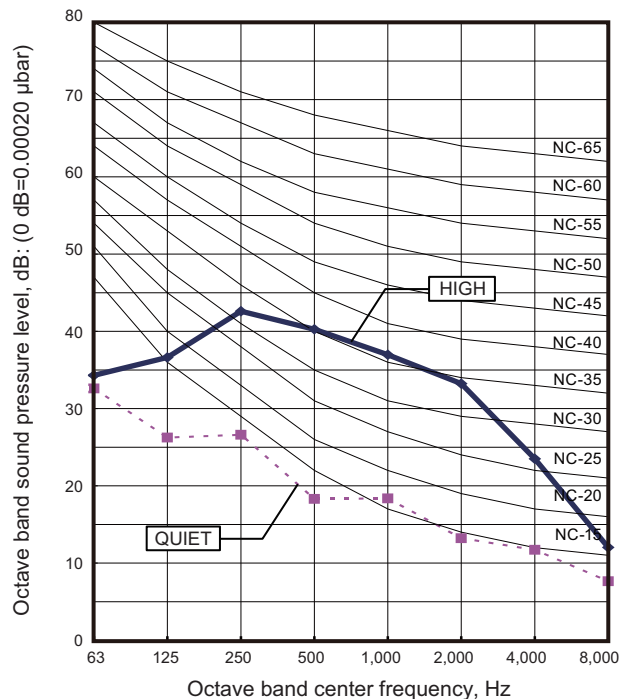

■ Model: AGYG14LVCA

● Cooling

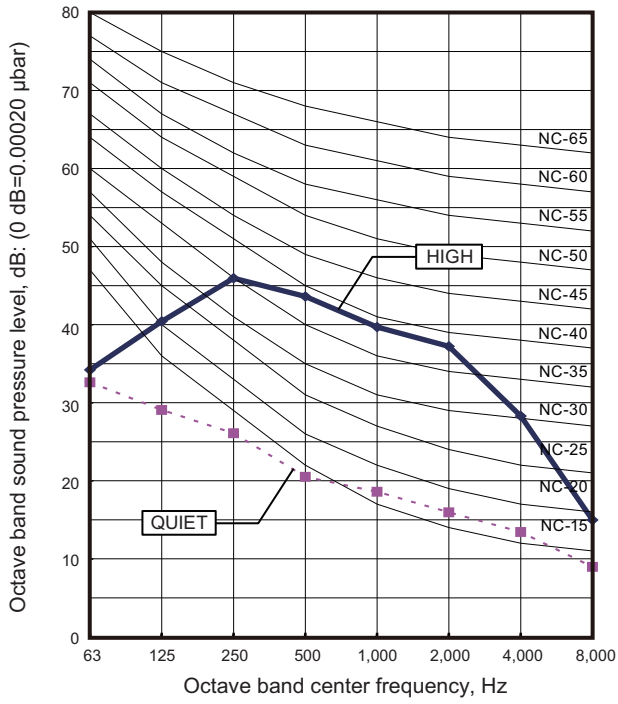

● Heating

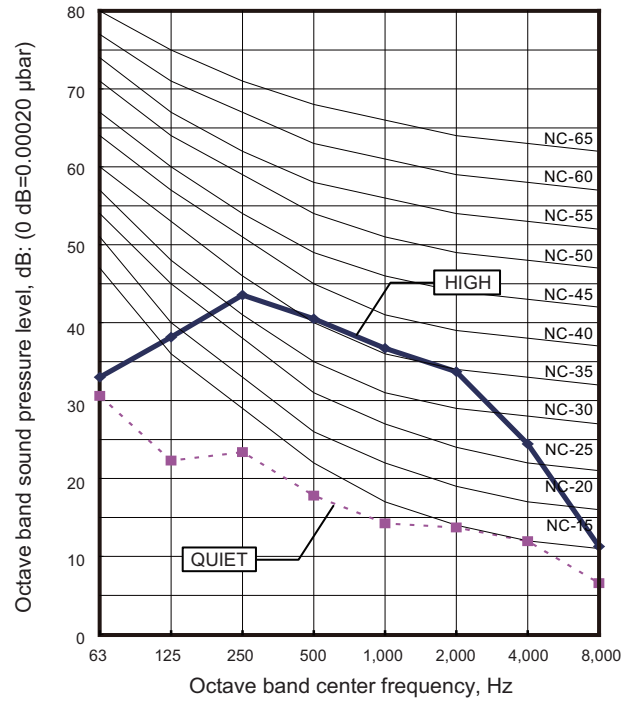

8-7. Sound level check point

■ Compact cassette type

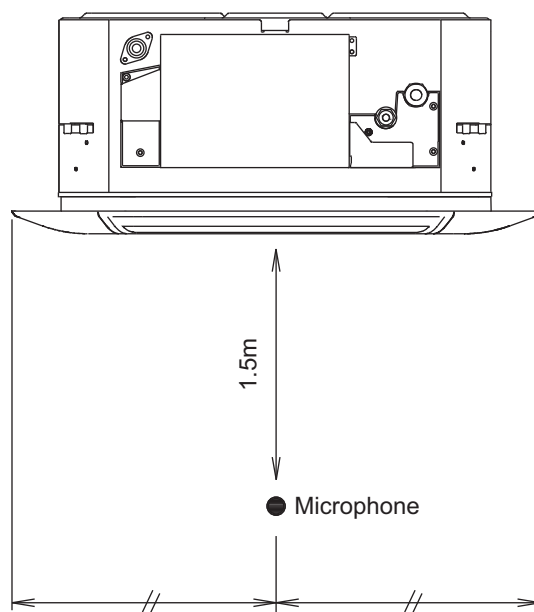
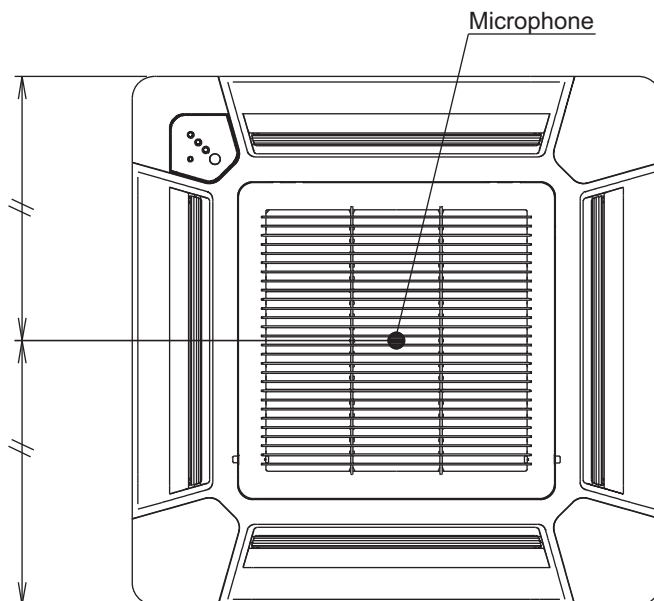

■ Slim duct type

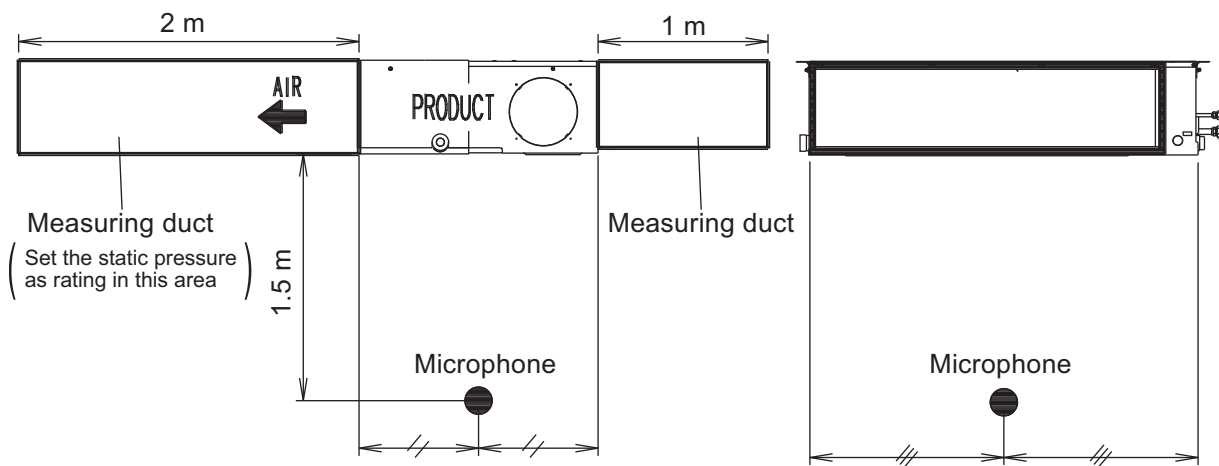

Side view

Front view

■ Mini duct type

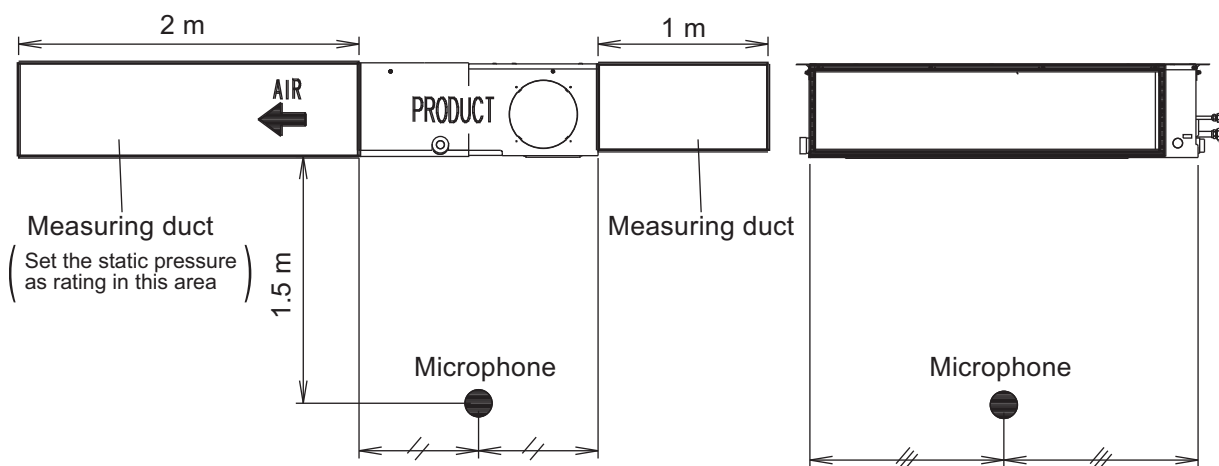

Side view

Front view

■ Wall mounted type

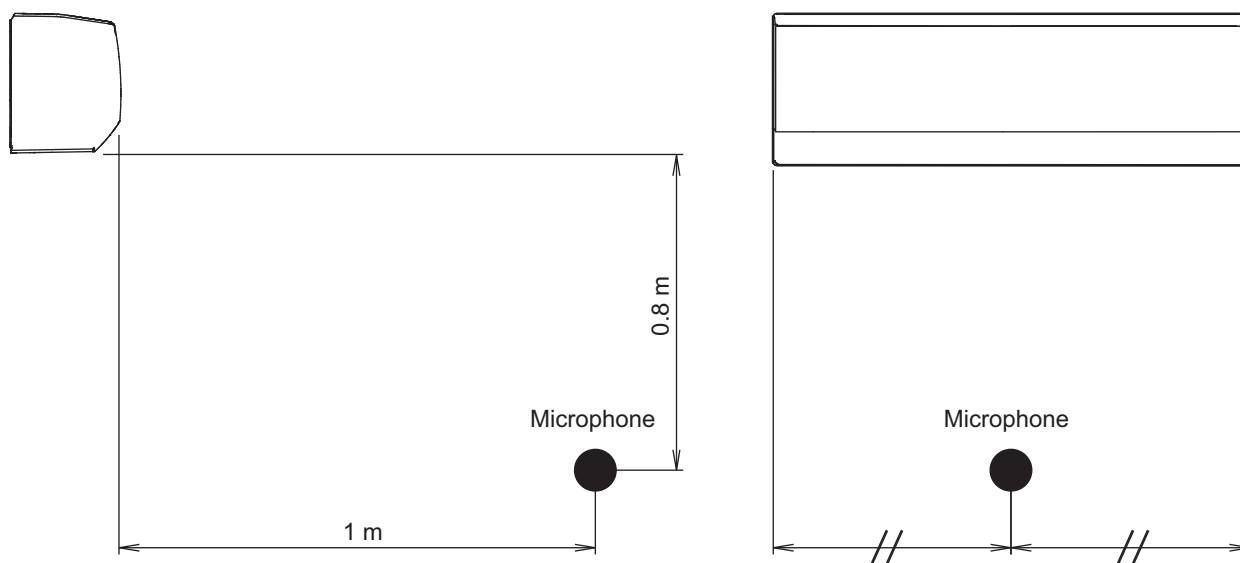

NOTE: Detailed shape of the actual indoor unit might be slightly different from the one illustrated above.

■ Floor/Ceiling type

- Floor console

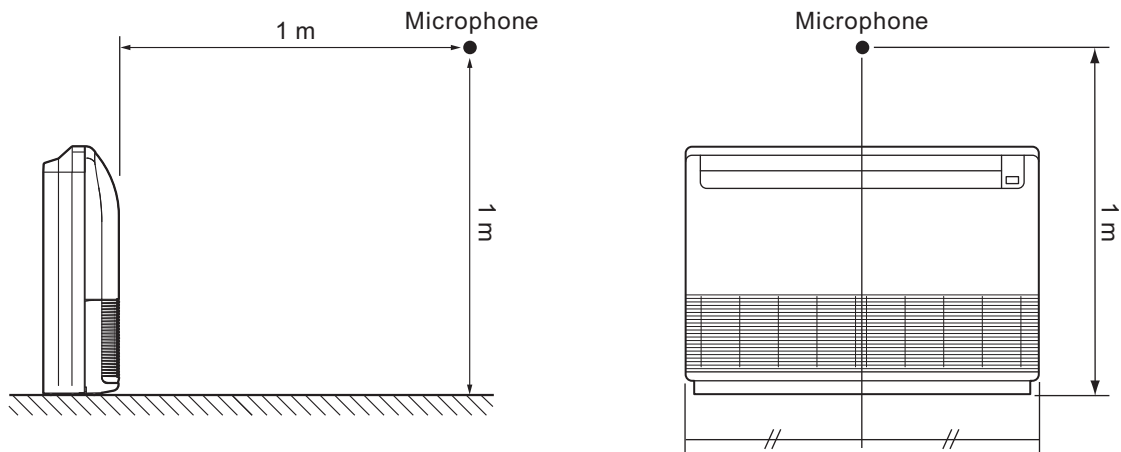

- Under ceiling

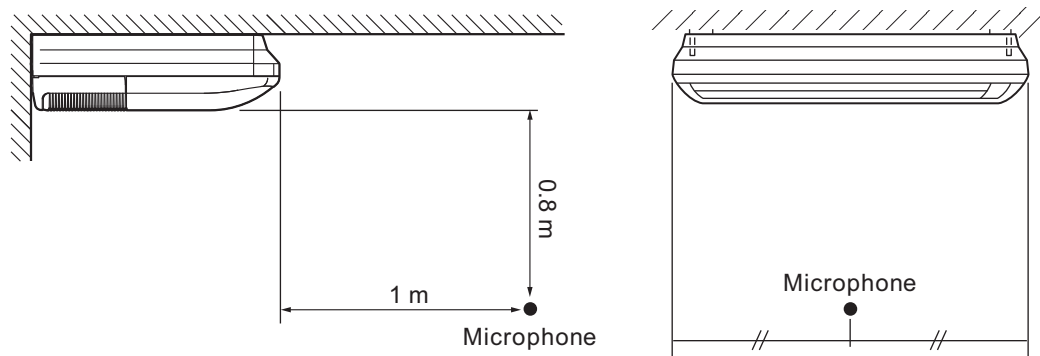

■ Floor type

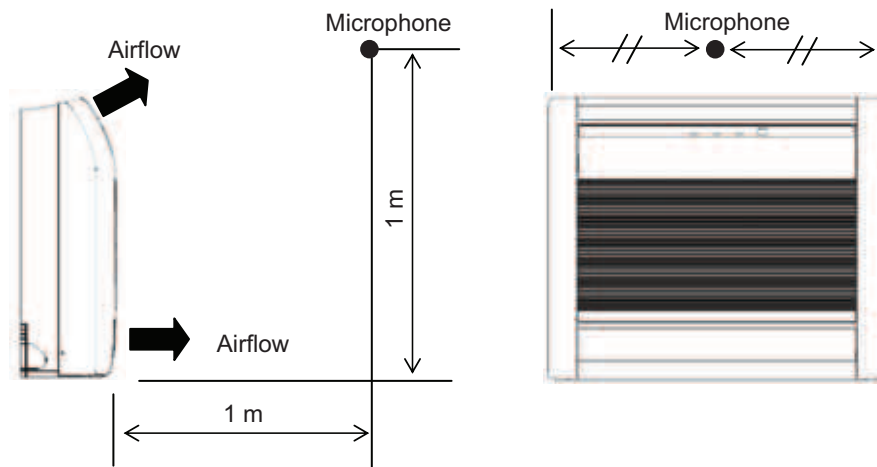

9. Electrical characteristics

Type	Model name	Power supply			Indoor rated	
		Hz	Voltage (V)	MCA (A)	Input power (W)	FLA (A)
Compact cassette	AUYG07LVLA	50	230	0.19	18	0.15
	AUYG09LVLA			0.19	18	0.15
	AUYG12LVLB			0.24	23	0.19
	AUYG14LVLB			0.28	28	0.22
	AUYG18LVLB			0.38	39	0.30
Mini duct	ARYG07LSLAP			0.33	33	0.29
	ARYG09LSLAP			0.38	40	0.33
	ARYG12LSLAP			0.42	47	0.38
	ARYG14LSLAP			0.67	72	0.58
	ARYG18LSLAP			0.61	63	0.49
Slim duct	ARYG07LLTA			0.41	33	0.33
	ARYG09LLTA			0.38	49	0.30
	ARYG12LLTB			0.44	58	0.35
	ARYG14LLTB			0.64	76	0.51
	ARYG18LLTB			0.55	73	0.44
Wall mounted	ASYG07LUCA			0.16	13	0.13
	ASYG09LUCA			0.18	16	0.14
	ASYG12LUCA			0.21	19	0.17
	ASYG14LUCA			0.25	23	0.20
	ASYG07LMCA			0.16	15	0.13
	ASYG07LMCE					
	ASYG09LMCA	0.19	17	0.15		
	ASYG09LMCE					
	ASYG12LMCA	0.24	22	0.19		
	ASYG12LMCE					
	ASYG14LMCA	0.31	28	0.25		
ASYG14LMCE						
ASYG18LFCA	0.41	37	0.33			
ASYG24LFCA	0.66	69	0.53			
ASYG24LFCC						
Floor/Ceiling	ABYG14LVTA	0.26	26	0.21		
	ABYG18LVTB	0.45	47	0.36		
Floor	AGYG09LVCA	0.19	16	0.15		
	AGYG12LVCA	0.23	20	0.18		
	AGYG14LVCA	0.25	23	0.20		

MCA: Minimum Circuit Ampacity = Maximum operating current (Full load)

FLA: Full Load Amperes (Fan motor)

10. Safety devices

Indoor unit type	Model name	PCB* fuse	Fan motor thermal protector	Terminal thermal fuse	Float switch
Compact cassette	AUYG07LVLA	250V, 3.15A	100 ± 10 °C	—	○
	AUYG09LVLA				
	AUYG12LVLB				
	AUYG14LVLB				
	AUYG18LVLB				
Mini duct	ARYG07LSLAP	250V, 5A	135 ± 15 °C	—	○
	ARYG09LSLAP				
	ARYG12LSLAP				
	ARYG14LSLAP				
	ARYG18LSLAP				
Slim duct	ARYG07LLTA	250V, 5A	135 ± 15 °C	—	○
	ARYG09LLTA				
	ARYG12LLTB				
	ARYG14LLTB				
	ARYG18LLTB				
Wall mounted	ASYG07LUCA	250V, 3.15A	150 ± 15 °C	102 °C Off	—
	ASYG09LUCA				
	ASYG12LUCA				
	ASYG14LUCA				
	ASYG07LMCA				
	ASYG07LMCE	140—195 °C	—	—	
	ASYG09LMCA				
	ASYG09LMCE				
	ASYG12LMCA				
	ASYG12LMCE				
	ASYG14LMCA				
	ASYG14LMCE				
	ASYG18LFCA				
ASYG24LFCA	120 ± 15 °C	102 °C Off	—		
ASYG24LFCC					
Floor/Ceiling	ABYG14LVTA	250V, 3.15A	135 ± 15 °C	—	—
	ABYG18LVTB				
Floor	AGYG09LVCA	250V, 3.15A	150 ± 15 °C	102 °C Off	—
	AGYG12LVCA				
	AGYG14LVCA				

*: Printed Circuit Board

11. External input and output

11-1. Compact cassette, slim duct, wall mounted, floor/ceiling, and floor types

Indoor unit type	External input	External output			
	Control input	Operation status output	Fresh air control output	Auxiliary heater output	Error status output
Compact cassette	•	•	•	—	—
Slim duct	•	•	•	•	—
Wall mounted	•	•	—	—	• (LU/LM types)
Floor/Ceiling	•	•	—	—	—
Floor	•	•	—	—	—

■ External input

With using external input function, some functions on this product can be controlled from an external device.

- “Operation/Stop” mode or “Forced stop” mode can be selected with function setting of indoor unit.
- A twisted pair cable (22AWG) should be used. Maximum length of cable is 150 m.
- The wire connection should be separate from the power cable line.

● Control input (Operation/Stop or Forced stop)

Indoor unit type		Connector
Compact cassette		CN102
Slim duct		
Wall mounted	LU/LM	CNA01
	LF	CN14
Floor/Ceiling		CN102
Floor		CN14

The air conditioner can be remotely operated by means of the following on-site work.

Operation is started at the following contents by adding the contact input of a commercial on/off switch to a connector on the external control PCB and turning it on.

Unit operation	Initial setting after power is on	Starting mode other than initial setting
Operation mode	Auto changeover	Mode at previous operation
Set temperature	24 °C	Temperature at previous operation
Airflow mode	AUTO	Mode at previous operation
Air direction (swing)	Standard air direction (swing: off)	Air direction at previous operation

• **Circuit diagram example**

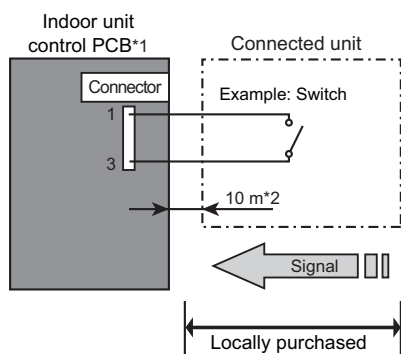

- Contact capacity: DC 24 V or more, 10 mA or more.
- *1: PCB of Communication kit is used for wall mounted type (LU and LM).
- *2: Make the distance from the PCB to the connected unit within 10 m.
- Use non-polar relays and switches.

Indoor unit type		1-pin (Polarity)	3-pin (Polarity)
Compact cassette		-	+
Slim duct		-	+
Wall mounted	LU	-	+
	LM	-	+
	LF	-	+
Floor/Ceiling		-	+
Floor		-	+

– When function setting is "Operation/Stop" mode

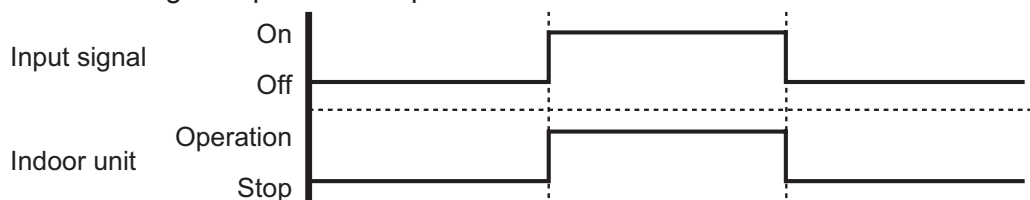

– When function setting is "Forced stop" mode

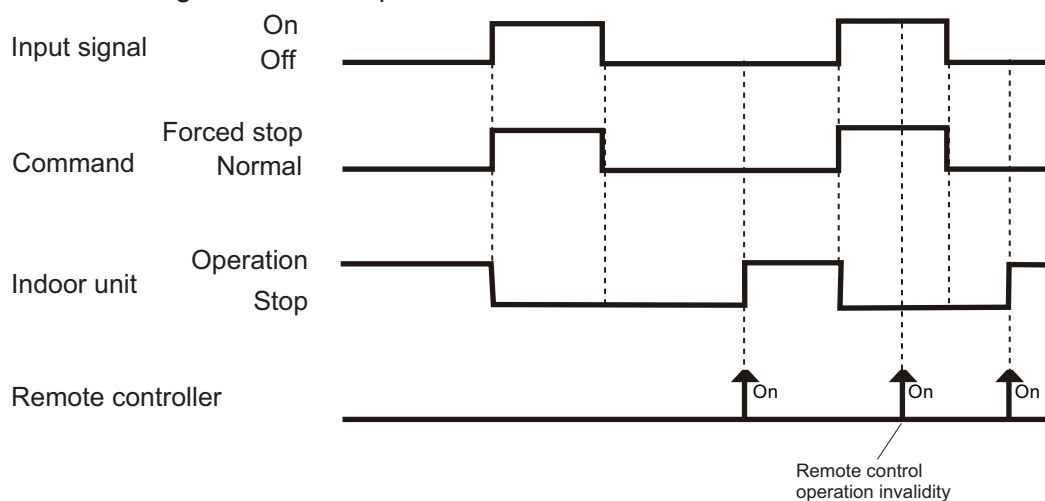

• Optional part

Indoor unit type		Part name	Model name
Compact cassette		External connect kit	UTY-XWZX
Slim duct			UTD-ECS5A
Wall mounted	LU		UTY-XWZXZ5
	LM		UTY-XWZXZ5
	LF		UTY-XWZX
Floor/Ceiling			UTY-XWZX
Floor			UTY-XWZX

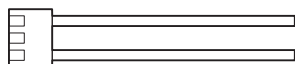

UTY-XWZX

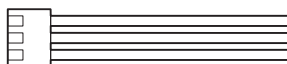

UTD-ECS5A

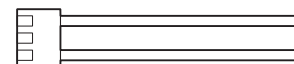

UTY-XWZXZ5

Indoor unit type		Part name	Model name
Compact cassette		—	—
Slim duct		—	—
Wall mounted	LU	Communication kit	UTY-TWBXF
	LM		UTY-XCBXZ2
	LF	—	—
Floor/Ceiling		—	—
Floor		—	—

*For operating the external input function, the wall mounted type (LU and LM) requires the following communication kit in addition to the wire (UTY-XWZXZ5 or UTY-XWZX).

External output

Use an external output cable with appropriate external dimension, depending on the number of cables to be installed.

Operation status output

Indoor unit type		Connector
Compact cassette		CN103
Slim duct		CN103
Wall mounted	LU/LM	CNB01
	LF	CN16
Floor/Ceiling		CN103
Floor		CN20

Air conditioner operation status signal can be output.

• Circuit diagram example

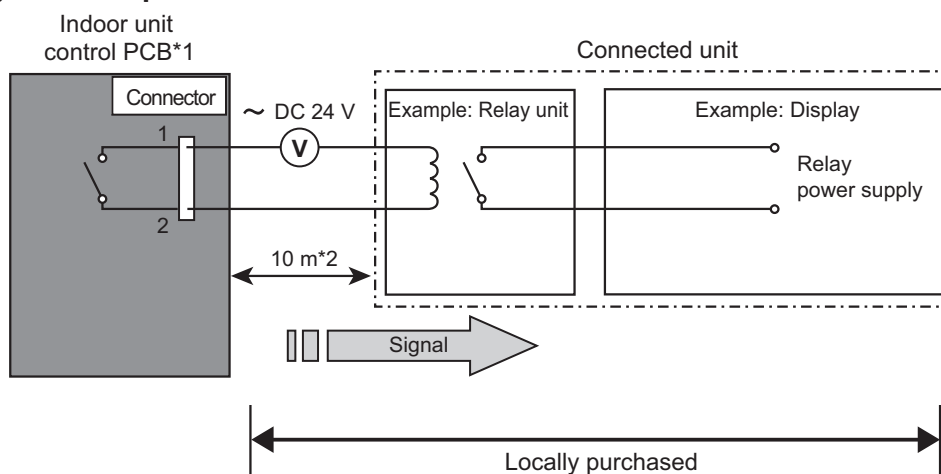

- *1: PCB of communication kit is used for wall mounted type (LU and LM).
- *2: Make the distance from the PCB to the connected unit within 10 m.
- Relay spec: Max. DC 24 V, 10 mA to less than 500 mA.

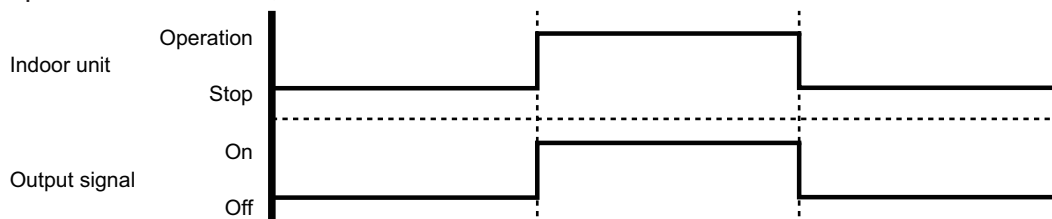

• Optional part

Indoor unit type		Part name	Model name
Compact cassette		External connect kit	UTY-XWZX
Slim duct			UTD-ECS5A
Wall mounted	LU		UTY-XWZXZ5
	LM		UTY-XWZXZ5
	LF		UTY-XWZX
Floor/Ceiling			UTY-XWZX
Floor			UTY-XWZX

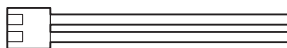

Indoor unit type		Part name	Model name
Compact cassette		—	—
Slim duct		—	—
Wall mounted	LU	Communication kit	UTY-TWBXF
	LM		UTY-XCBXZ2
	LF	—	—
Floor/Ceiling		—	—
Floor		—	—

*For operating the external output function, the wall mounted type (LU and LM) requires the following communication kit in addition to the wire (UTY-XWZXZ5 or UTY-XWZX).

● Fresh air control output

Indoor unit type	Connector
Compact cassette	CN6
Slim duct	
Wall mounted	—
Floor/Ceiling	—
Floor	—

Signal linked to air conditioner indoor fan on can be output.

* However, signal becomes off during cold air prevention control operation.

• Circuit diagram example

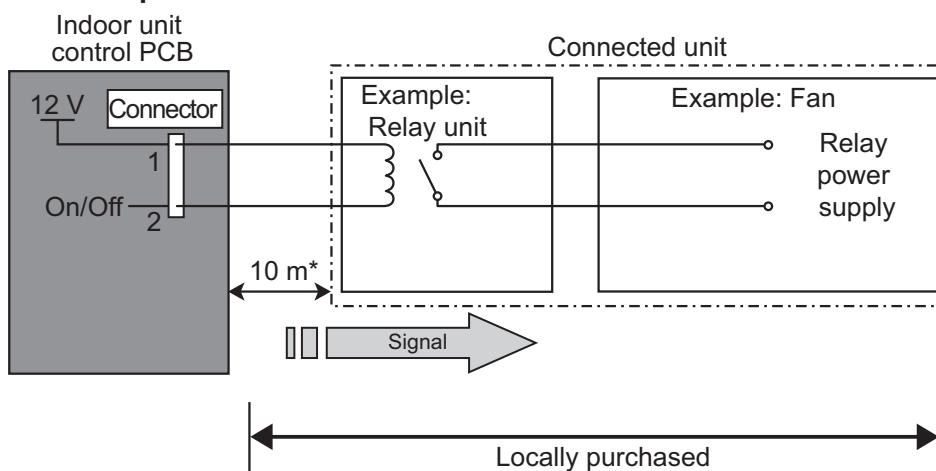

- *: Make the distance from the PCB to the connected unit within 10 m.
- Relay spec.: Rated DC 12 V, 50 mA to less.

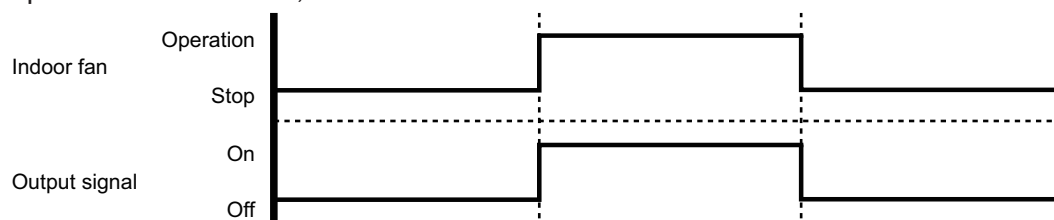

• Optional part

Indoor unit type	Part name	Model name
Compact cassette	Fresh air intake kit	UTZ-VXAA*
Slim duct	External control set	UTD-ECS5A
Wall mounted	—	—
Floor/Ceiling	—	—
Floor	—	—



*: This wire is included in fresh air intake kit (UTZ-VXAA).

● Auxiliary heater output

Indoor unit type	Connector
Compact cassette	—
Slim duct	CN10
Wall mounted	—
Floor/Ceiling	—
Floor	—

Signal is output from connector when indoor fan and compressor turn on under heating operation.

*Signal output performance specifications are as shown as follows:

Example: When Set Temperature (T_s) is 22 °C

- and room temperature (T_r) increase above 12 °C, signal output is on.
- and room temperature (T_r) increase above 21 °C, signal output is off.
- and room temperature (T_r) decrease below 19 °C, signal output is on.
- and room temperature (T_r) decrease below 10 °C, signal output is off.

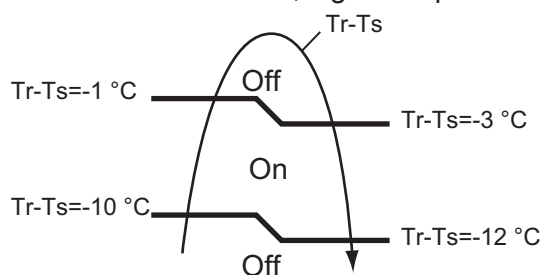

• Fan delay setting (JM3)

This is used to continue indoor unit fan operation for 1 minute after thermostat "Off" in heating mode.

1 minute delay control set by cutting jumper wire on PCB.

• **Circuit diagram example**

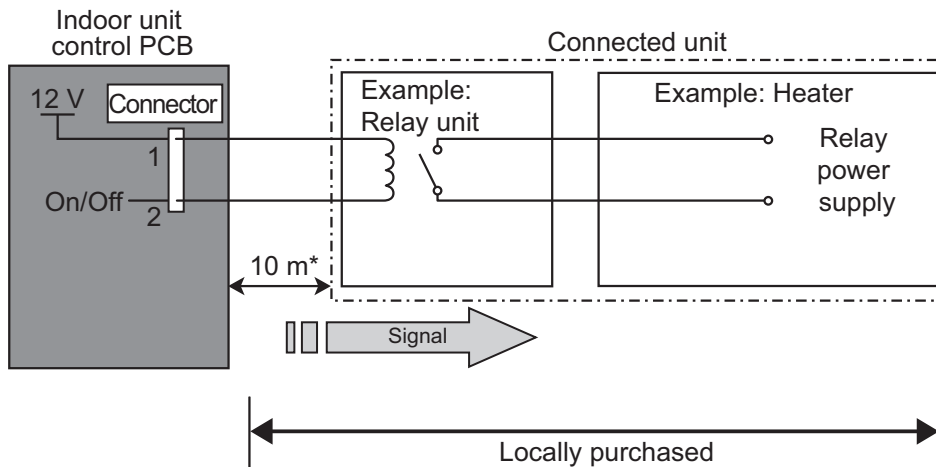

- Relay spec.: Rated DC 12 V, 50 mA to less.
- *: Make the distance from the PCB to the connected unit within 10 m.

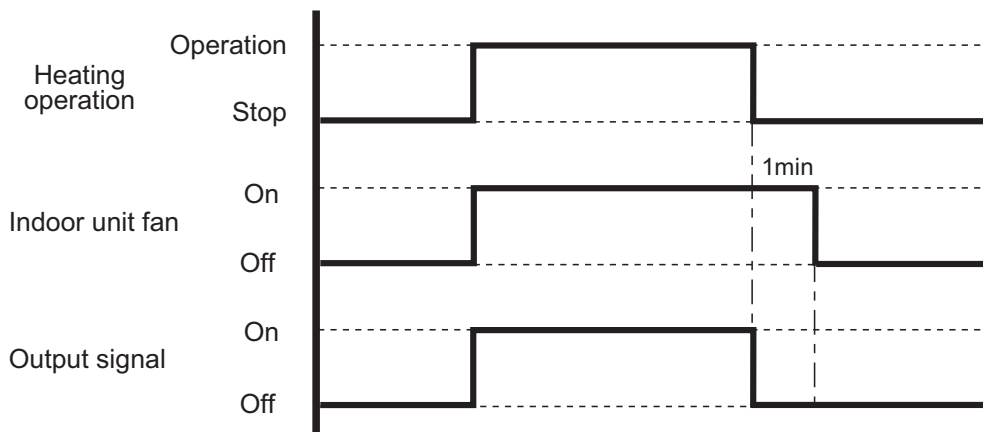

CAUTION

- Locate an external heater between the indoor unit and the outlet.

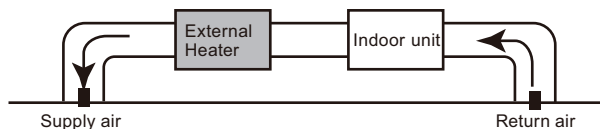

- Be sure to use delay control of a fan.

• **Optional part**

Indoor unit type	Part name	Model name
Compact cassette	—	—
Slim duct	External control set	UTD-ECS5A
Wall mounted	—	—
Floor/Ceiling	—	—
Floor	—	—



● Error status output

Indoor unit type		Connector
Compact cassette		—
Slim duct		—
Wall mounted	LU/LM	CNB02
	LF	—
Floor/Ceiling		—
Floor		—

Air conditioner error status signal can be output.

• Circuit diagram example

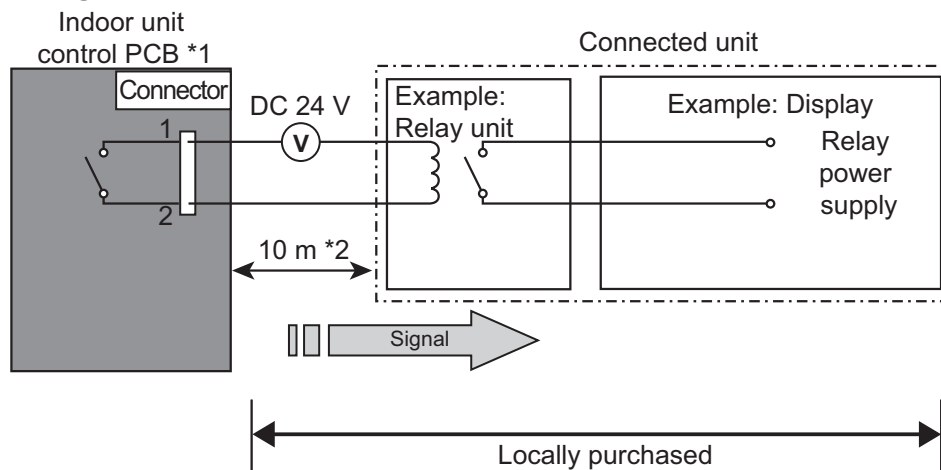

- *1: PCB of communication kit is used for wall mounted type .
- *2: Make the distance from the PCB to the connected unit within 10 m.
- Relay spec.: Max. DC 24 V, 10 mA to less than 500 mA.

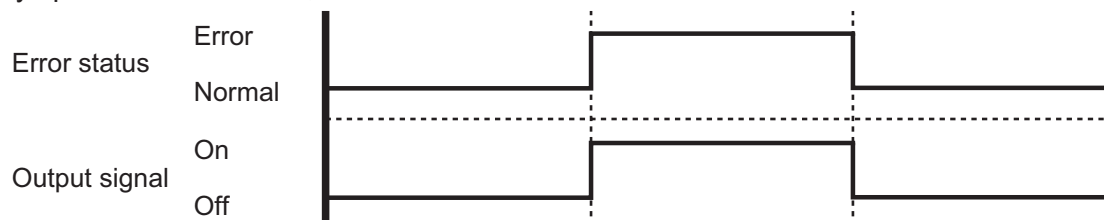

• Optional part

Indoor unit type		Part name	Model name
Compact cassette		—	—
Slim duct		—	—
Wall mounted	LU	External connect kit	UTY-XWZXZ5
	LM		UTY-XWZXZ5
	LF	—	—
Floor/Ceiling		—	—
Floor		—	—

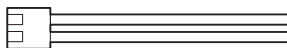

Indoor unit type		Part name	Model name
Compact cassette		—	—
Slim duct		—	—
Wall mounted	LU	Communication kit	UTY-TWBXF
	LM		UTY-XCBXZ2
	LF	—	—
Floor/Ceiling		—	—
Floor		—	—

*For operating the external output function, the wall mounted type (LU and LM) requires the following communication kit in addition to the wire (UTY-XWZXZ5 or UTY-XWZX).

11-2. Mini duct type

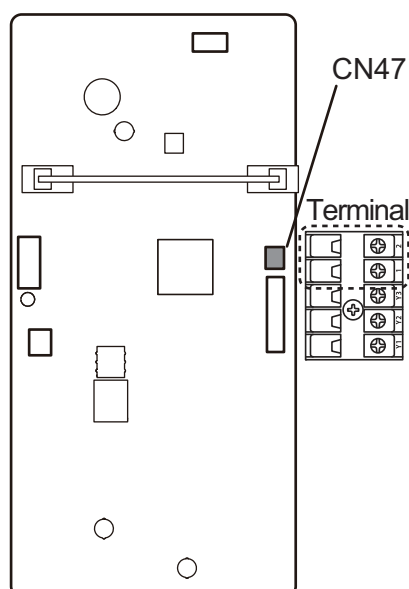

External input and output		Connector	Input select	Input signal	External connect kit (Optional parts)
External input	Operation/Stop Forced stop	Terminal	Dry contact	Edge	—
External output	Operation status	CN47	—	—	UTY-XWZXZG
	Error status				
	Indoor unit fan operation status				
	External heater output				

External input

With using external input function, some functions on this product can be controlled from an external device.

- “Operation/Stop” mode or “Forced stop” mode can be selected with function setting of indoor unit.
- A twisted pair cable (22AWG) should be used. Maximum length of cable is 150 m.
- The wire connection should be separate from the power cable line.

Indoor unit functions such as Operation/Stop can be done by using indoor unit terminals.

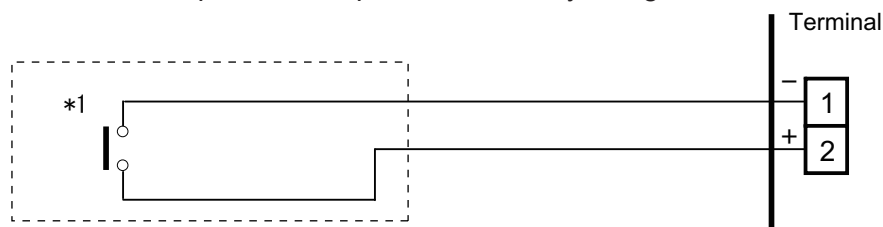

*1: The switch can be used on the following condition: DC 12 V to 24 V, 1 mA to 15 mA.

External output

Use an external output cable with appropriate external dimension, depending on the number of cables to be installed.

- A twisted pair cable (22AWG) should be used. Maximum length of cable is 25 m.
- Output voltage: High DC 12 V \pm 2 V, Low 0 V.
- Permissible current: 50 mA
- For details, refer to ["Combination of external input and output"](#) on page 150.

When indicator, etc. are connected directly

Example: Function setting 60 is set to "00"

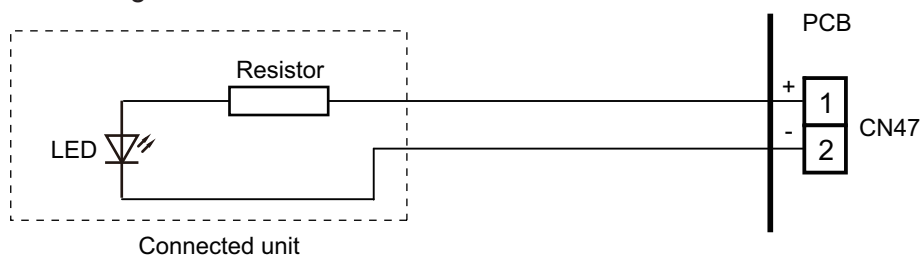

When connecting with a device equipped with a power supply

Example: Function setting 60 is set to "00"

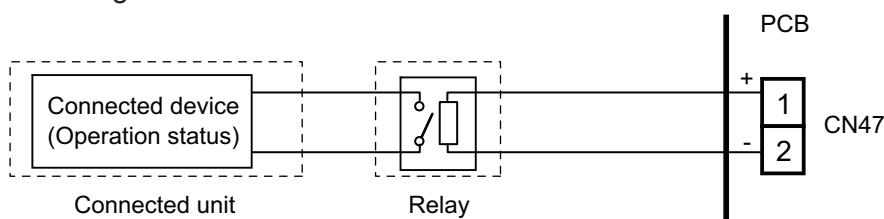

■ Combination of external input and output

By combining the function setting of the indoor unit, you can select various combinations of functions.

Combination examples of external input and output are as follows:

Mode	Function setting	External input	External output
		Terminal	C47
0	60—00	Operation/Stop	
1—8	60—01 to 60—08	(Setting prohibited)	
9	60—09	Operation/Stop	Error status
10	60—10	Operation/Stop	Indoor unit fan operation status
11	60—11	Operation/Stop	External heater output

NOTE: Input of Operation/Stop depends on the setting of function setting 46.

- 00: Operation/Stop mode 1 (R.C. enabled)
- 01: (Setting prohibited)
- 02: Forced stop
- 03: Operation/Stop mode 2 (R.C. disabled)

● Input signal type

- Indoor unit
Input signal type is only "Edge".



■ Details of function

● Control input function

- When function setting is "Operation/Stop" mode 1

Function setting	External input	Input signal	Command
46—00	Terminal	Off → On	Operation
		On → Off	Stop

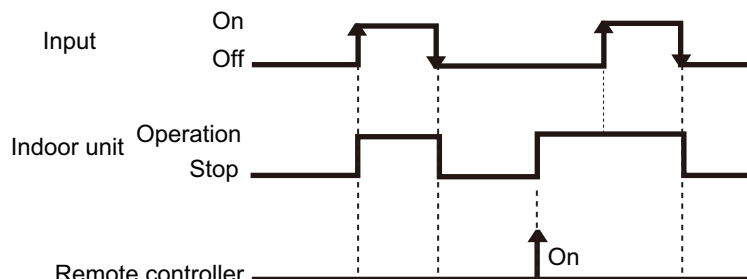

NOTES:

- The last command has priority.
- The indoor units within the same remote controller group operates in the same mode.

- When function setting is "Forced stop" mode

Function setting	External input	Input signal	Command
46—02	Terminal	Off → On	Forced stop
		On → Off	Normal

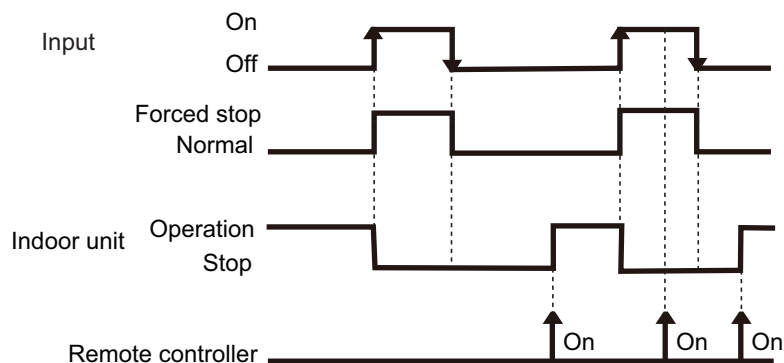

NOTES:

- When the forced stop is triggered, indoor unit stops and Operation/Stop operation by the remote controller is restricted.
- When forced stop function is used with forming a remote controller group, connect the same equipment to each indoor unit within the group.

• When function setting is "Operation/Stop" mode 2

Function setting	External input	Input signal	Command
46—03	Terminal	Off → On	Operation
		On → Off	Stop (R.C. disabled)

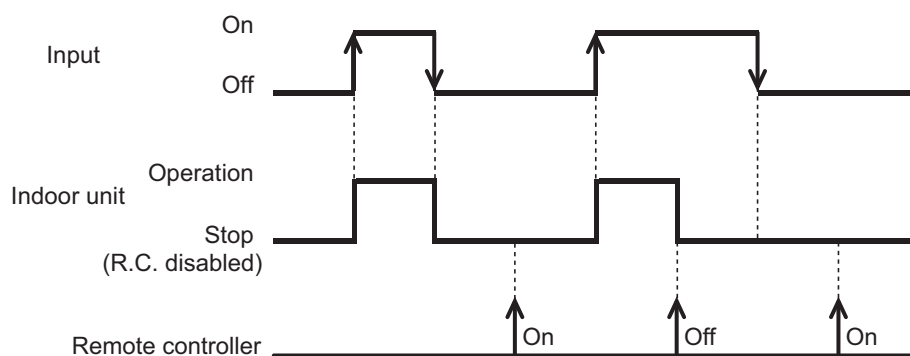

NOTE: When "Operation/Stop" mode 2 function is used with forming a remote controller group, connect the same equipment to each indoor unit within the group.

● Control output function

Function setting	External output	Output signal	Command
60—00	CN47	Low → High	Operation
		High → Low	Stop

The output is low when the unit is stopped.



● Error status

Function setting	External output	Output signal	Command
60—09	CN47	Low → High	Error
		High → Low	Normal

The output is ON when an error is generated for the indoor unit.

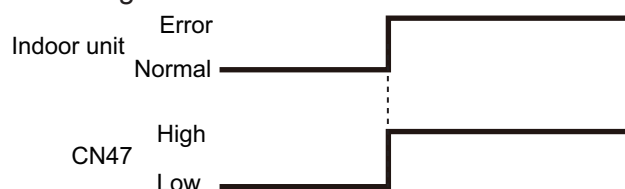

● Indoor unit fan operation status

Function setting	External output	Output signal	Command
60—10	CN47	Low → High	Fan run
		High → Low	Fan stop

Output signal	Condition
On	The indoor unit fan is operating.
Low → High	
Off	The fan is stopped or during cold air prevention. During thermostat off when in dry mode operation.
High → Low	

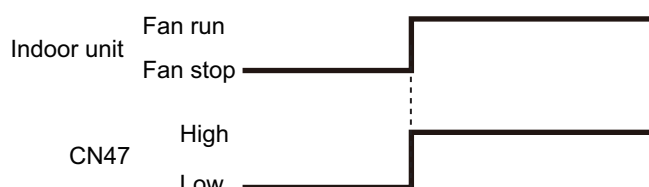

● External heater output

Function setting	External output	Output signal	Command
60—11	CN47	Low → High	Heater on
		High → Low	Heater off

Output signal	Condition
Low → High	Heater turns on as shown in diagram of heating temperature
Off → On	
High → Low	Heater turns off as shown in diagram of heating temperature
On → Off	<ul style="list-style-type: none"> • Other than Heating mode • Error occurred • Forced thermo off • Fan stop protection

Specifications of the signal output performance are as shown as follows:

Example When set temperature (T_s) is set at 22 °C;

- And room temperature (T_r) increase above 12 °C, signal output is on.
- And T_r increase above 21 °C, signal output is off.
- And T_r decrease below 19 °C, signal output is on.
- And T_r decrease below 10 °C, signal output is off.

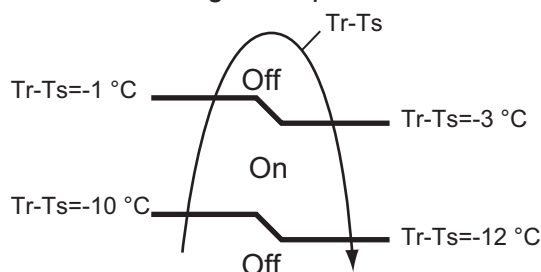

The output also turns off in defrost operation.

12. Group connection

Wiring regulation on the remote controllers in the multi split models are reviewed and allowed for group connection.

Example of group connection

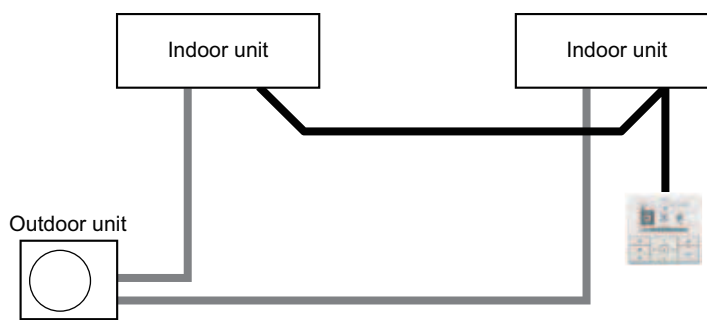

*Exterior of each device shown above might be different from the actual one.

NOTES:

- Group connection is applicable for multi system consists of following products that are produced in 2013 or later:
 - LU/LM/LF series in wall mounted type
 - Floor type
- Maximum number of connectable indoor units is depend on the outdoor unit.
- Non-polar 2-wired remote controller and Polar 3-wired remote controller cannot be connected within same group connection.

12-1. Precautions on creating a group connection

Take precautions on items described in this section when creating a group connection in the multi split models.

⚠ CAUTION

Group connection to other refrigerant system between the multi systems with same communication system as shown below is strictly prohibited.

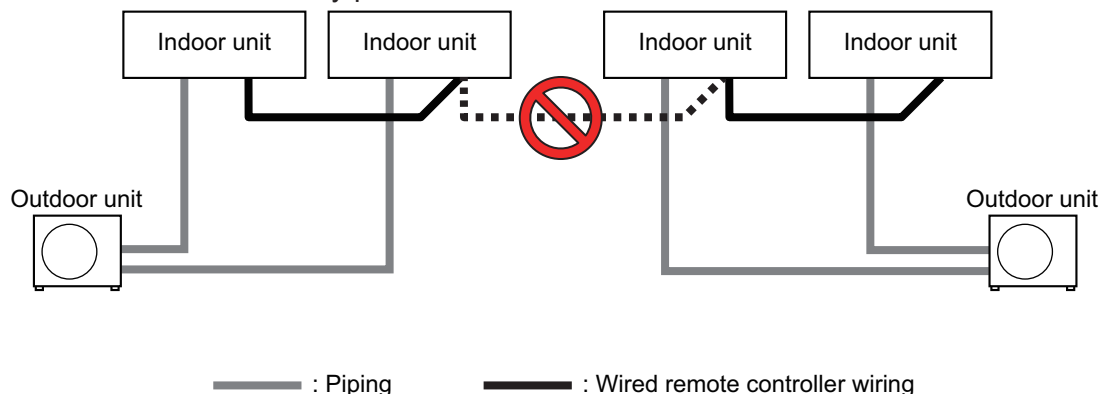

- Group connection is allowed only in the same refrigerant system. (Maximum number of connectable indoor units is depend on the outdoor unit.)

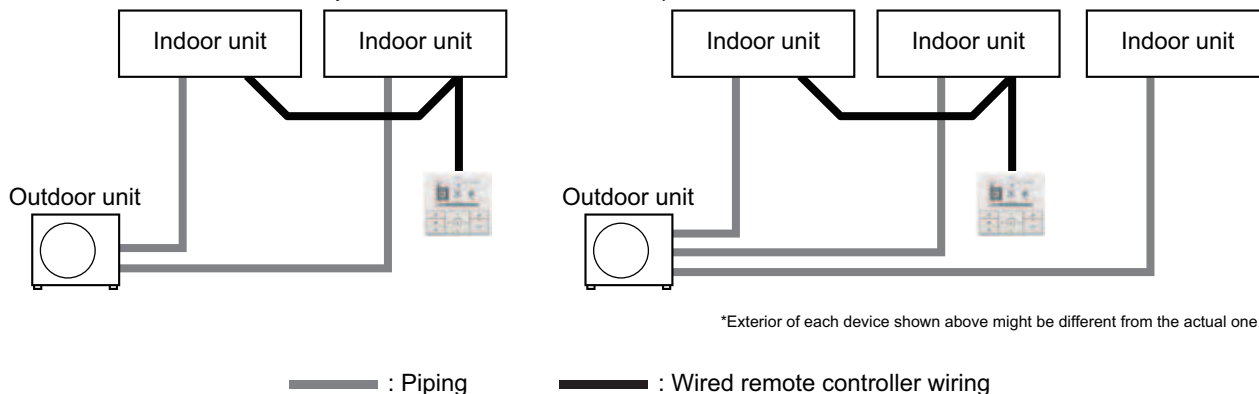

*Exterior of each device shown above might be different from the actual one.

- Central remote controller (UTY-DMMYM) cannot be connected simultaneously.

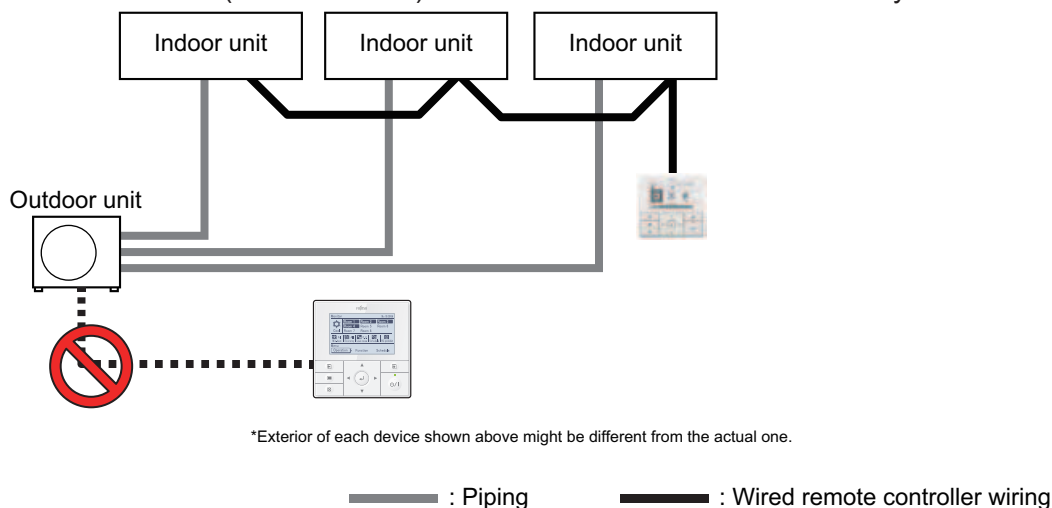

*Exterior of each device shown above might be different from the actual one.

- **Maximum wiring length of the remote controller cable: 300 m**
Even if the maximum wiring length of the product itself is specified as longer than 300 m, the maximum length of the remote controller cable will be 300 m if the system is group-connected.
When total wiring length is longer than 100 m, the cable diameter needs to be changed as follows:

Total wiring length of remote controller cable Unit: m	Cross section of cable Unit: mm ²
100 or less	0.3—0.8
100—200	0.5—0.8
200—300	0.8

- **Required parts for group connection**

- Optional part:

Indoor unit type	Communication kit	
Wall mounted	LU	UTY-TWBXF
	LM	UTY-XCBXZ2

As for the optional parts, refer to Chapter 16-3. "Others" on page 266.

- Service part: Wire with connector (Service part no. 9705932012)

Wiring example for multiple remote control or group control:

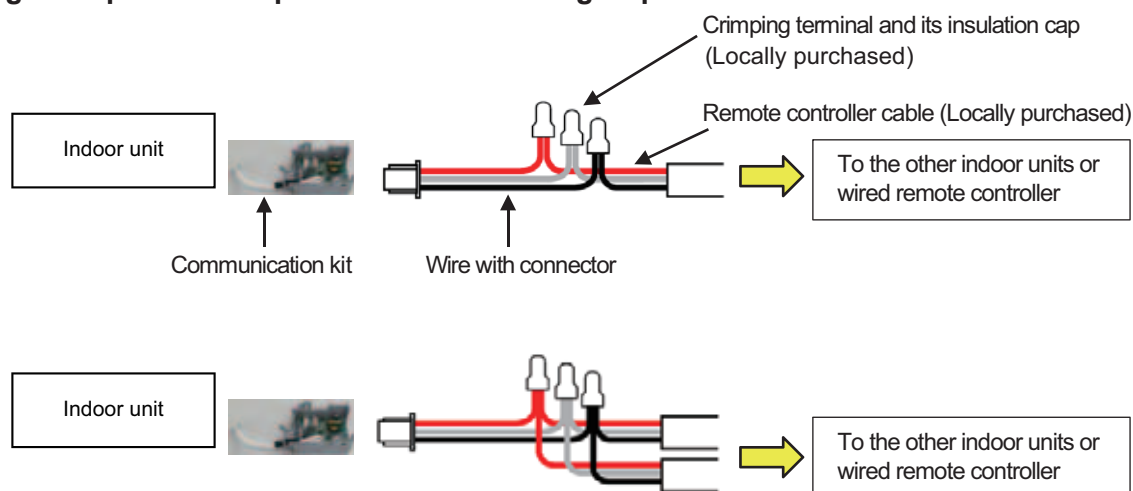

NOTES:

- Conceal the wirings of the group connection inside of the wall or by means of trunking at the thickness of 1-mm or more to prevent electrical shocks when getting in touch with the cables under certain circumstances.
- When using the Communication kit for wall mounted type, store the crimping terminals inside the Communication kit.
- In the wireless remote controllers for the group connection, its remote controller address can be set by its own. For the details, refer to following section "Remote controller address setting procedure for wireless remote controllers".
An error is displayed immediately just turning on the power to effect the settings of the group connection. However the error will automatically disappear when the subsequent function setting is completed.
- Bundle the wires with a cable tie to prevent external pressures apply on the crimping terminals. (Ensure that the tensile strength for the splicing position is 10 N or above.)

12-2. Remote controller address setting procedure for wireless remote controllers

1. Enter the function setting mode of the wireless remote controller. For details, refer to "[Function settings](#)" on page 198.
2. Select the function number "00" (Remote controller address setting), and then select any of the number (Setting value) from 00 to 15. (Factory setting: 00)

13. Remote controller

13-1. Wireless remote controller (AR-RAH2E/AR-RAH1E)

Overview

AR-RAH2E

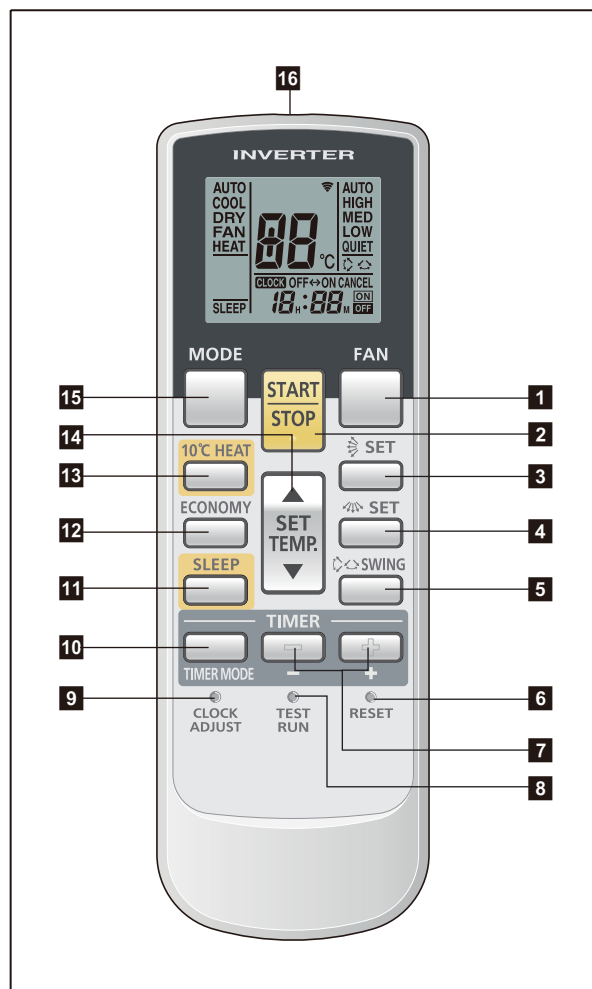

Display panel

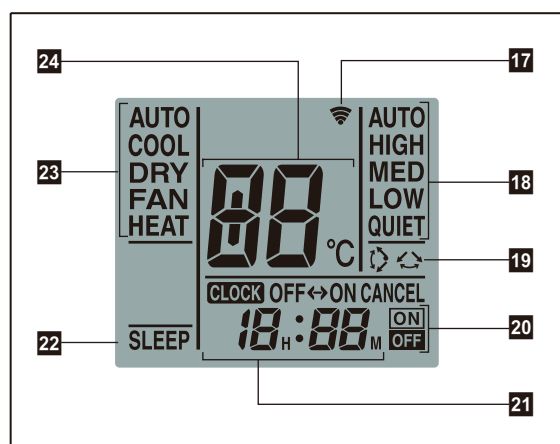

NOTE: Functions may differ by type of the indoor unit. For details, refer to the operation manual.

1 FAN button

Selects the fan speed (AUTO, HIGH, MED, LOW, and QUIET).

2 START/STOP button

Starts and stops operation.

3 SET button (vertical)

Adjusts the vertical airflow direction.

4 SET button (horizontal)

Adjusts the horizontal airflow direction.

5 SWING button

Sets the automatic swing operation and selects swing mode (Up/down, Left/right, Up/down/left/right, and Stop swing).

6 RESET button

Used when replacing batteries.

7 Timer set (- / +) button

Sets the current time and on-off time.

8 TEST RUN button

Only used for the initial test in the unit installation.

9 CLOCK ADJUST button

Used for adjusting the clock.

10 TIMER MODE button

Selects the timer mode (off timer, on timer, program timer, and timer reset).

11 SLEEP button

Pressed to select sleep timer.

12 ECONOMY button

13 10 °C HEAT button

14 SET TEMP. (temperature) (▲ / ▼) button

- Sets desired temperature.
- Sets remote controller custom code.

15 MODE button

- Switches operation mode (AUTO, COOL, DRY, FAN, and HEAT).
- Starts/ends the remote controller custom code (max. 4 types) change.

16 Signal transmitter

17 Signal transmit indicator

18 Fan speed indicator

19 Swing indicator

20 Timer mode indicator

21 Clock indicator

22 Sleep indicator

23 Operating mode indicator

24 Temperature indicator

● AR-RAH1E

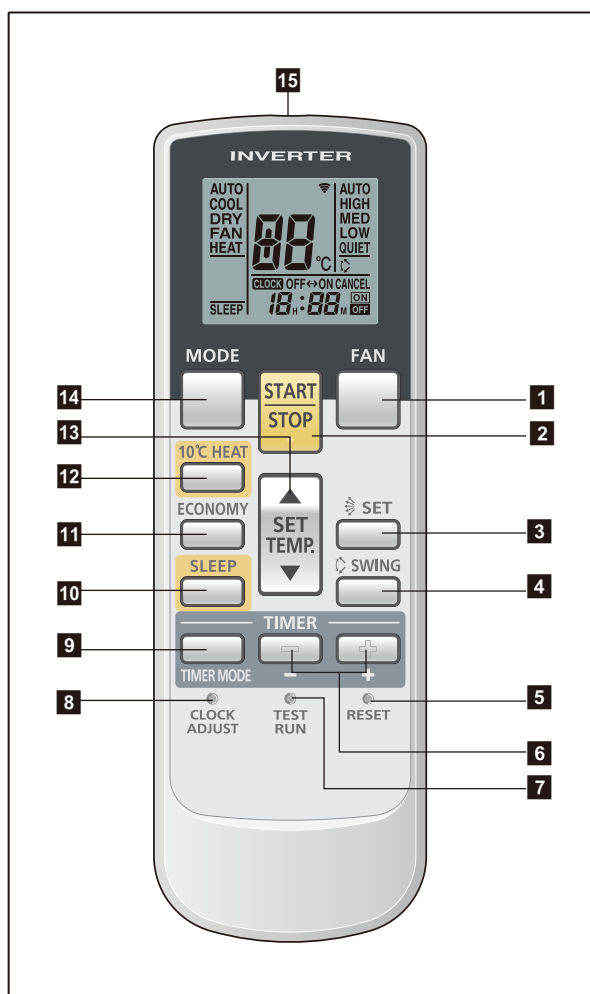

Display panel

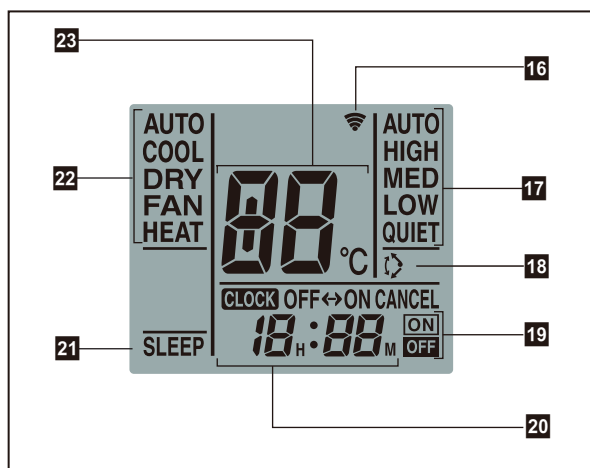

NOTE: Functions may differ by type of the indoor unit. For details, refer to the operation manual.

1 FAN button

Selects the fan speed (AUTO, HIGH, MED, LOW, and QUIET).

2 START/STOP button

Starts and stops operation.

3 SET button (vertical)

Adjusts the vertical airflow direction.

4 SWING button

Sets the automatic swing operation and selects swing mode (Left/right, Stop swing).

5 RESET button

Used when replacing batteries.

6 Timer set (- / +) button

Sets the current time and on-off time.

7 TEST RUN button

Only used for the initial test in the unit installation.

8 CLOCK ADJUST button

Used for adjusting the clock.

9 TIMER MODE button

Selects the timer mode (off timer, on timer, program timer, and timer reset).

10 SLEEP button

Pressed to select sleep timer.

11 ECONOMY button

12 10 °C HEAT button

13 SET TEMP. (temperature) (▲ / ▼) button

- Sets desired temperature.
- Sets remote controller custom code.

14 MODE button

- Switches operation mode (AUTO, COOL, DRY, FAN, and HEAT).
- Starts/ends the remote controller custom code (max. 4 types) change.

15 Signal transmitter

16 Signal transmit indicator

17 Fan speed indicator

18 Swing indicator

19 Timer mode indicator

20 Clock indicator

21 Sleep indicator

22 Operating mode indicator

23 Temperature indicator

■ Specifications

● Controller

Unit: mm

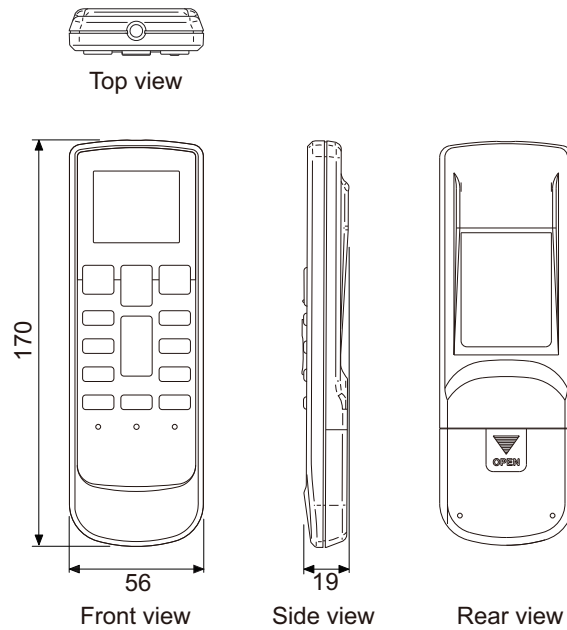

Size (H × W × D)	mm	170 × 56 × 19
Weight	g	85 (without batteries)

NOTE: Actual number of buttons might be different from the figure above.

● Holder

Unit: mm

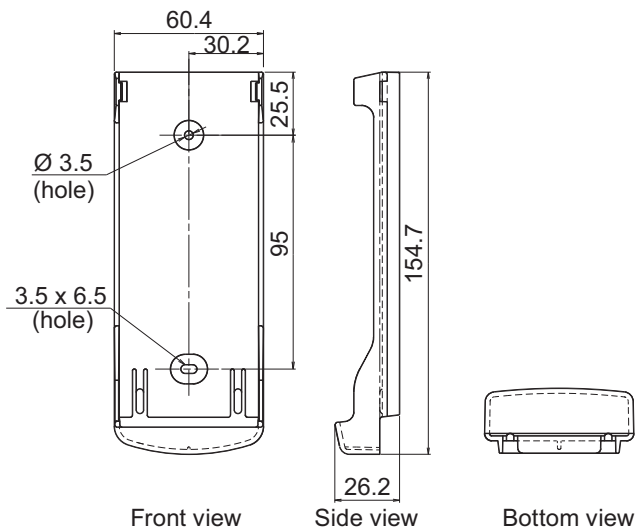

Size (H × W × D)	mm	154.7 × 60.4 × 26.2
Weight	g	28

13-2. Wireless remote controller (AR-REA2E/AR-REB1E)

Overview

- AR-REA2E

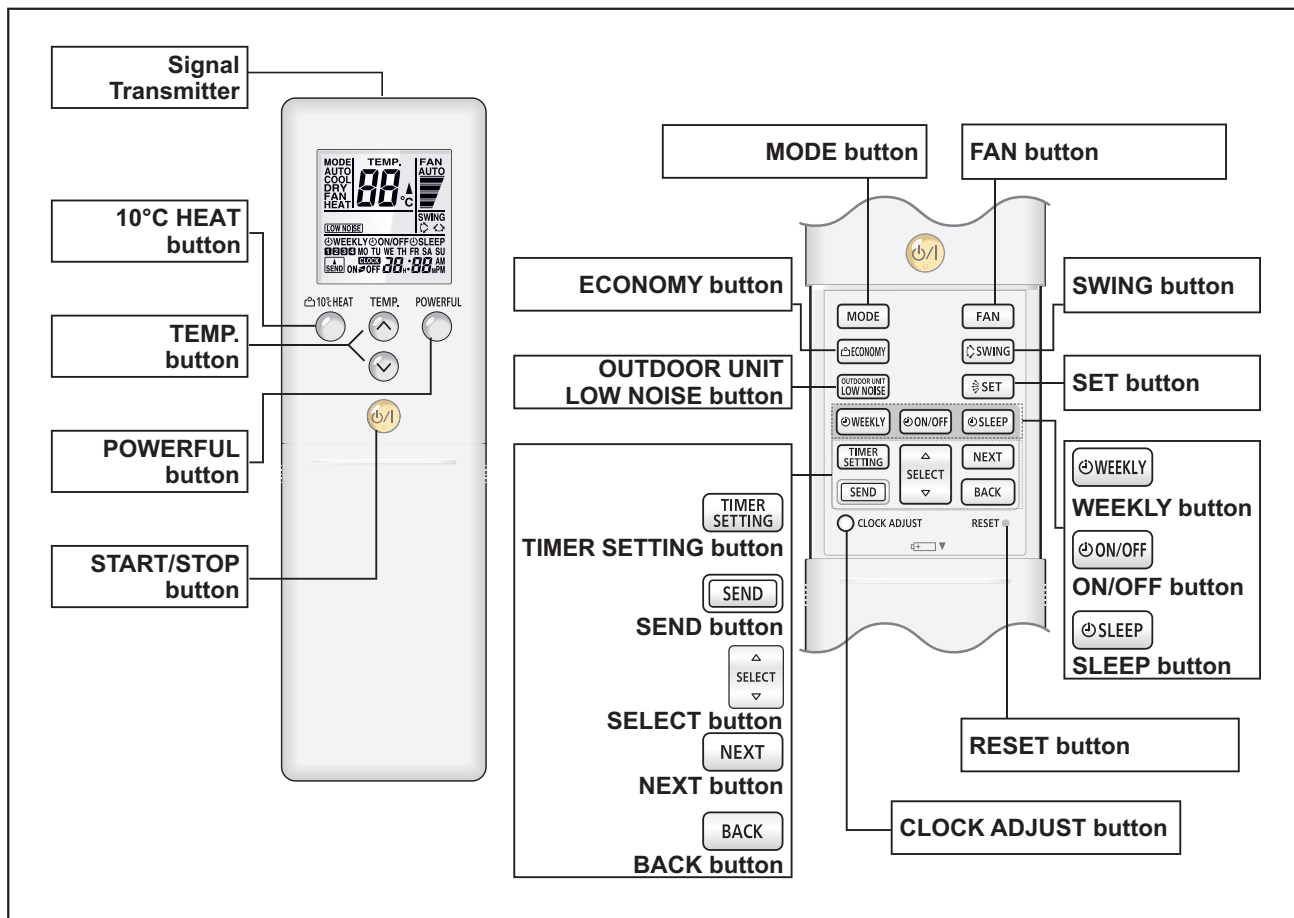

NOTE: Functions may differ by type of the indoor unit. For details, refer to the operation manual.
Display panel

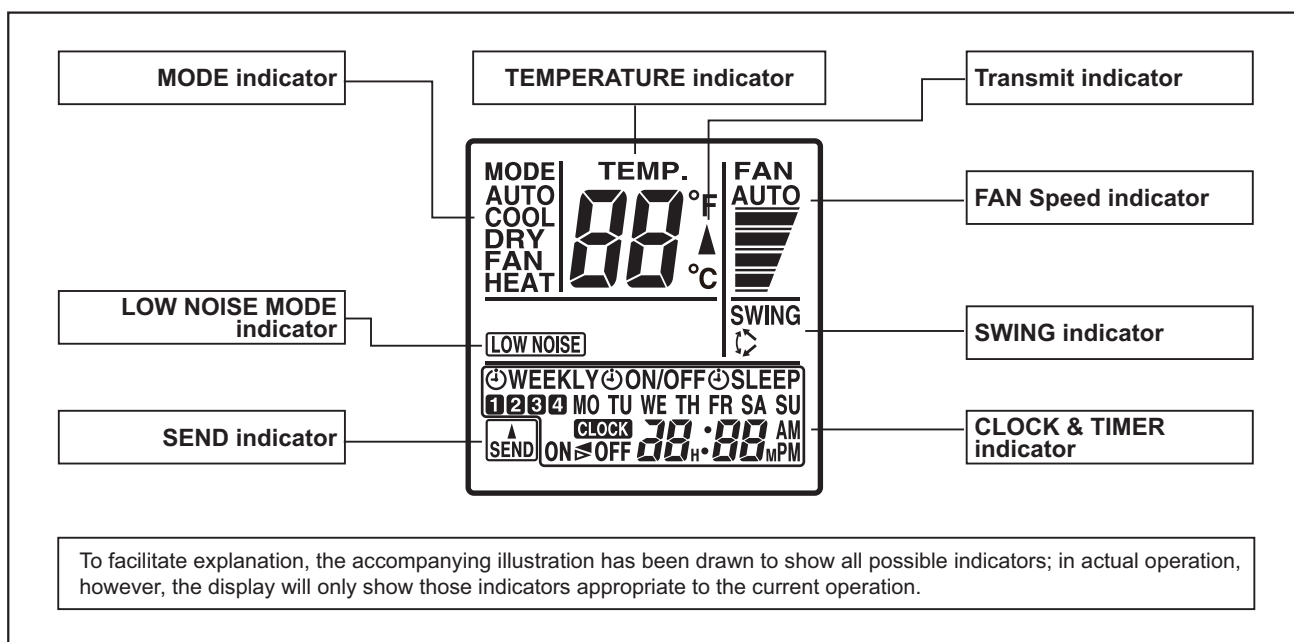

To facilitate explanation, the accompanying illustration has been drawn to show all possible indicators; in actual operation, however, the display will only show those indicators appropriate to the current operation.

• AR-REB1E

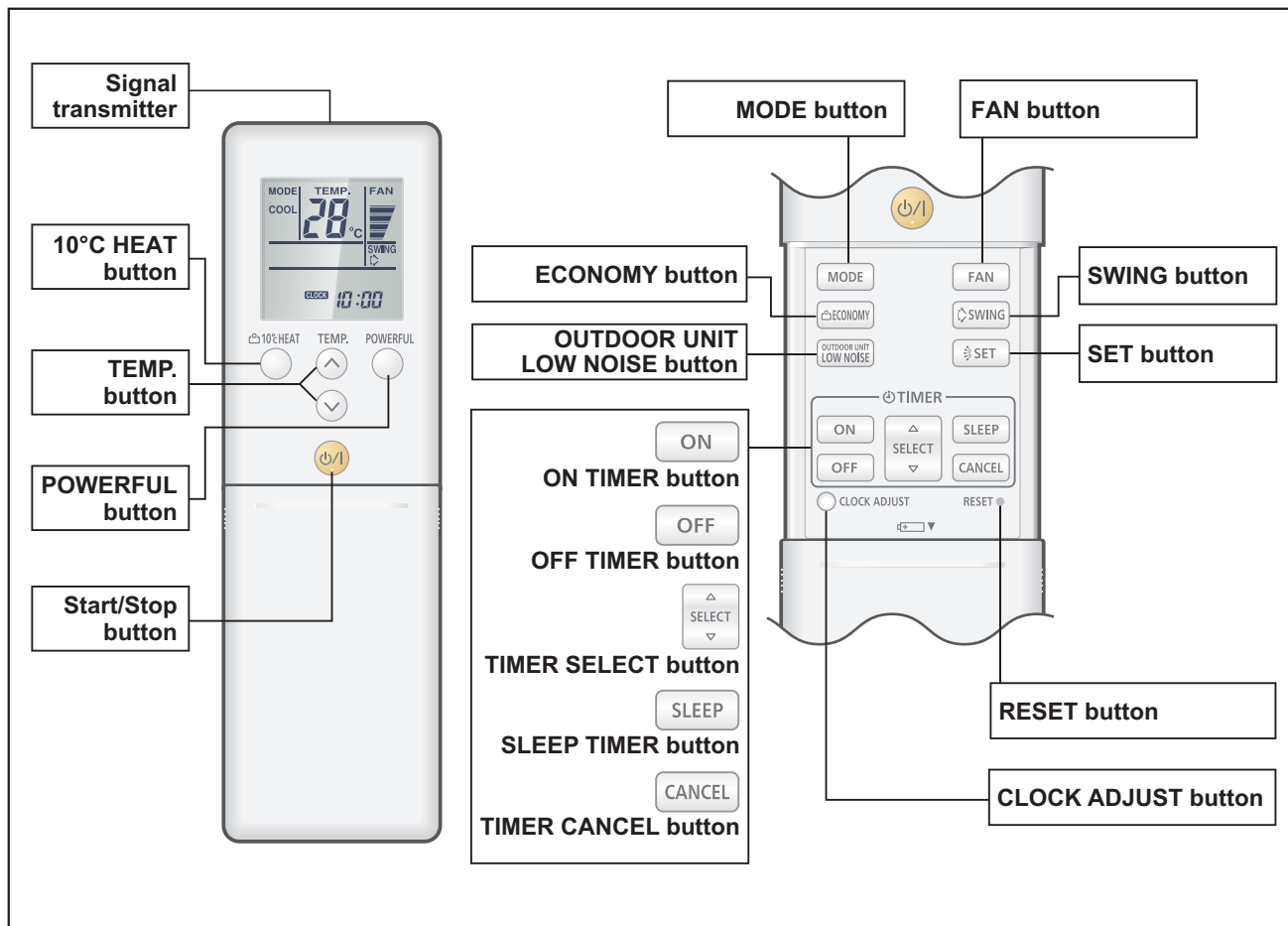

NOTE: Functions may differ by type of the indoor unit. For details, refer to the operation manual.
Display panel

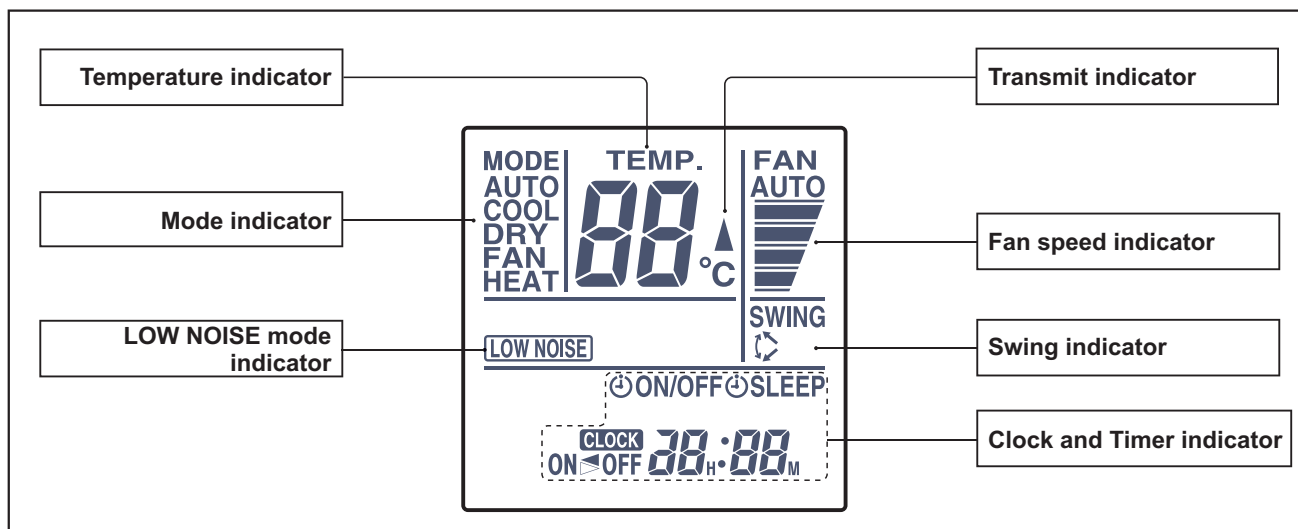

To facilitate explanation, the accompanying illustration has been drawn to show all possible indicators; in actual operation, however, the display will only show those indicators appropriate to the current operation.

■ Specifications

● Controller

Unit: mm

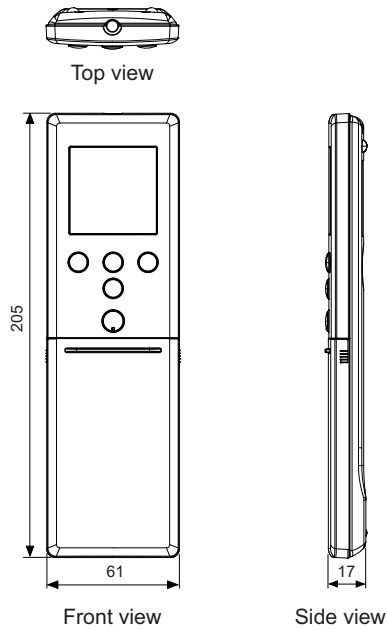

Size (H × W × D)	mm	205 × 61 × 17
Weight	g	122 (without batteries)

● Holder

Unit: mm

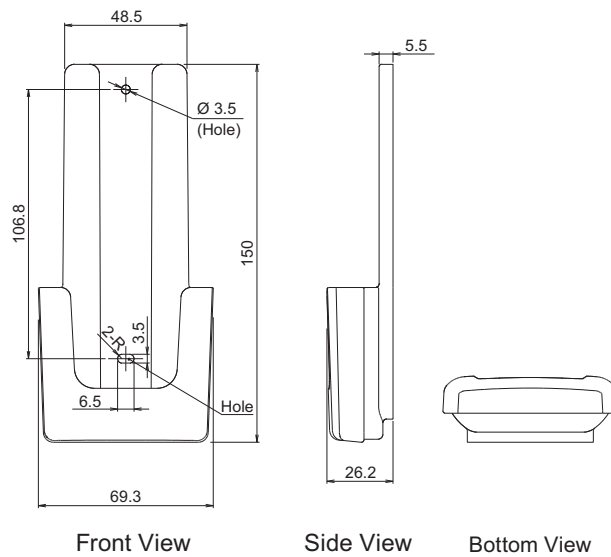

Size (H × W × D)	mm	150 × 69.3 × 26.2
Weight	g	27

13-3. IR receiver kit with Wireless remote controller (UTY-LRHYM: Optional part)

Overview

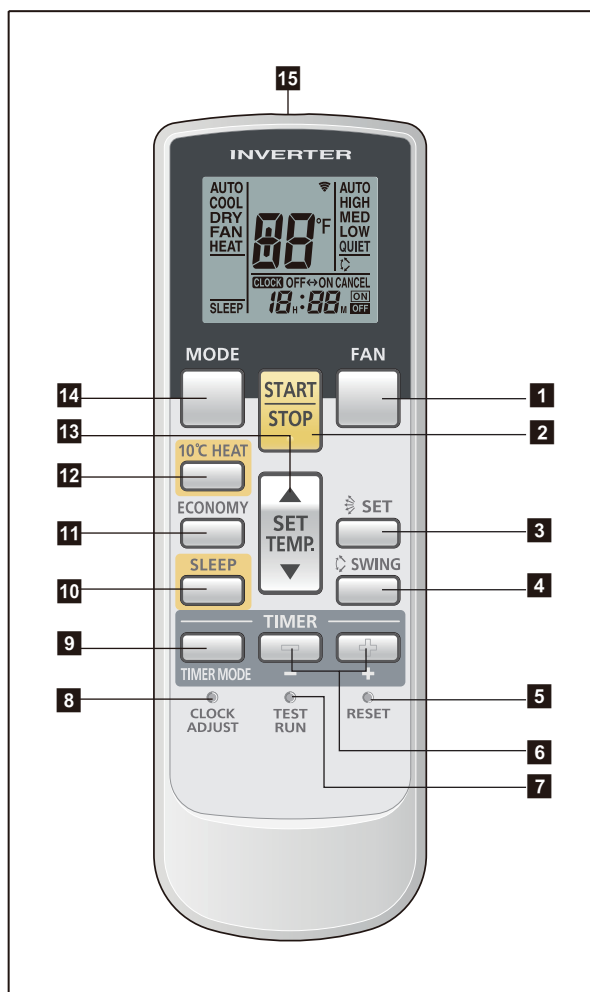

Display panel

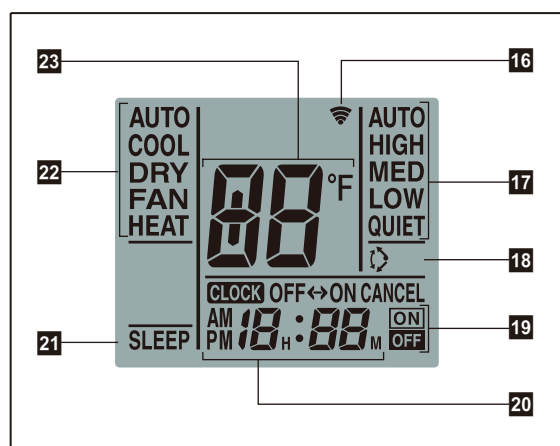

NOTE: Functions may differ by type of the indoor unit. For details, refer to the operation manual.

- 1 FAN button**
Selects the fan speed (AUTO, HIGH, MED, LOW, and QUIET).
- 2 START/STOP button**
Starts and stops operation.
- 3 SET button (vertical)**
Adjusts the vertical airflow direction.
- 4 SWING button**
Sets the automatic swing operation and selects swing mode (Up/down, Left/right, Up/down/left/right, and Stop swing).
- 5 RESET button**
Used when replacing batteries.
- 6 Timer set (- / +) button**
Sets the current time and on-off time.
- 7 TEST RUN button**
Only used for the initial test in the unit installation.
- 8 CLOCK ADJUST button**
Used for adjusting the clock.
- 9 TIMER MODE button**
Selects the timer mode (off timer, on timer, program timer, and timer reset).
- 10 SLEEP button**
Pressed to select sleep timer.
- 11 ECONOMY button**
- 12 10 °C HEAT button**
- 13 SET TEMP. (temperature) (▲ / ▼) button**
 - Sets desired temperature.
 - Sets remote controller custom code.
- 14 MODE button**
 - Switches operation mode (AUTO, COOL, DRY, FAN, and HEAT).
 - Starts/ends the remote controller custom code (max. 4 types) change.
- 15 Signal transmitter**
- 16 Signal transmit indicator**
- 17 Fan speed indicator**
- 18 Swing indicator**
- 19 Timer mode indicator**
- 20 Clock indicator**
- 21 Sleep indicator**
- 22 Operating mode indicator**
- 23 Temperature indicator**

Specifications

● Controller

Unit: mm

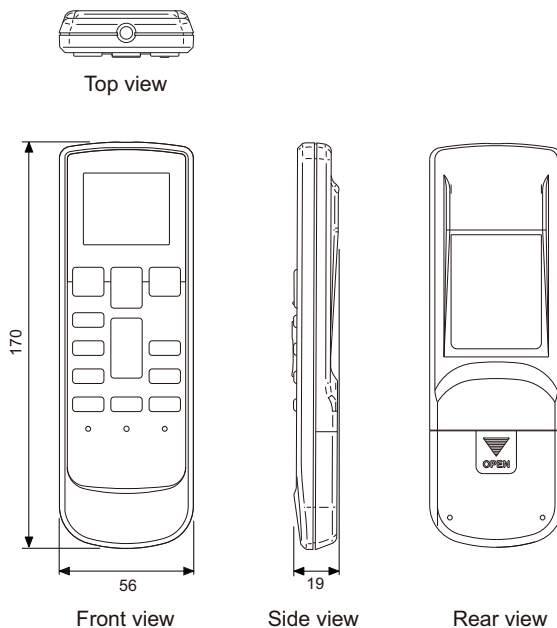

Size (H × W × D)	mm	170 × 56 × 19
Weight	g	85 (without batteries)

● Holder

Unit: mm

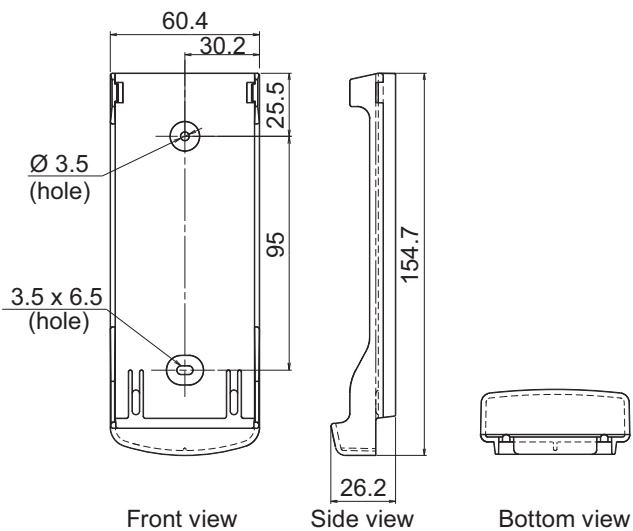

Size (H × W × D)	mm	154.7 × 60.4 × 26.2
Weight	g	28

● IR receiver

Unit: mm

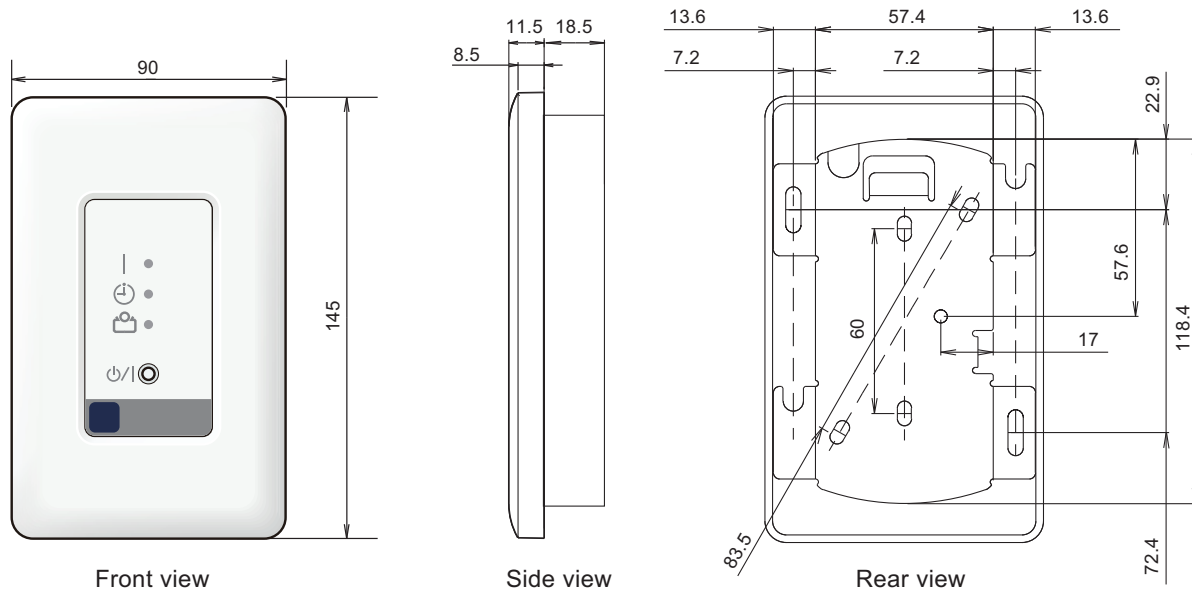

Size (H × W × D)	mm	145 × 90 × 30
Weight	g	150

13-4. IR receiver kit with Wireless remote controller (UTY-LBTYM: Optional part)

Overview

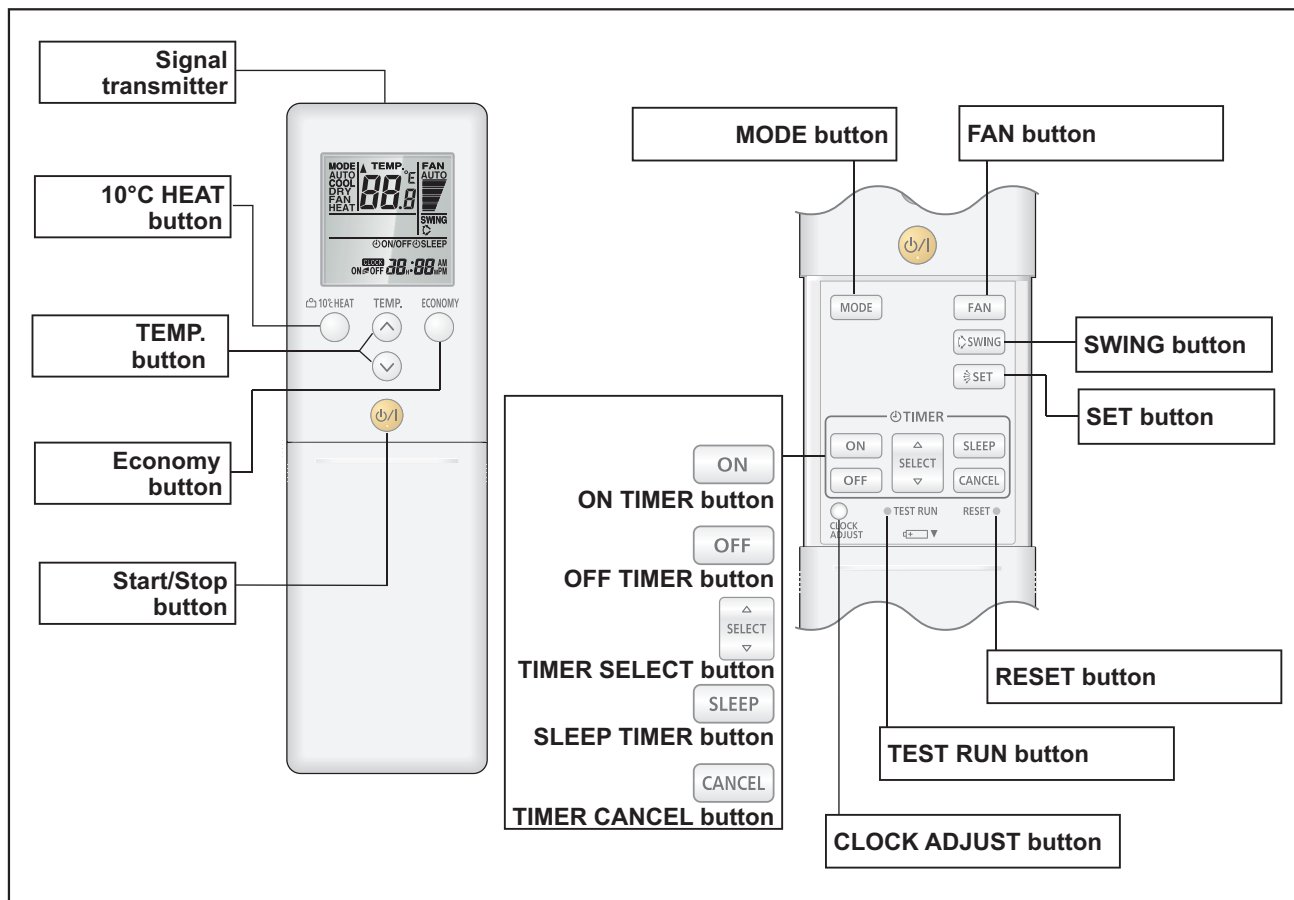

NOTE: Functions may differ by type of the indoor unit. For details, refer to the operation manual.
Display panel

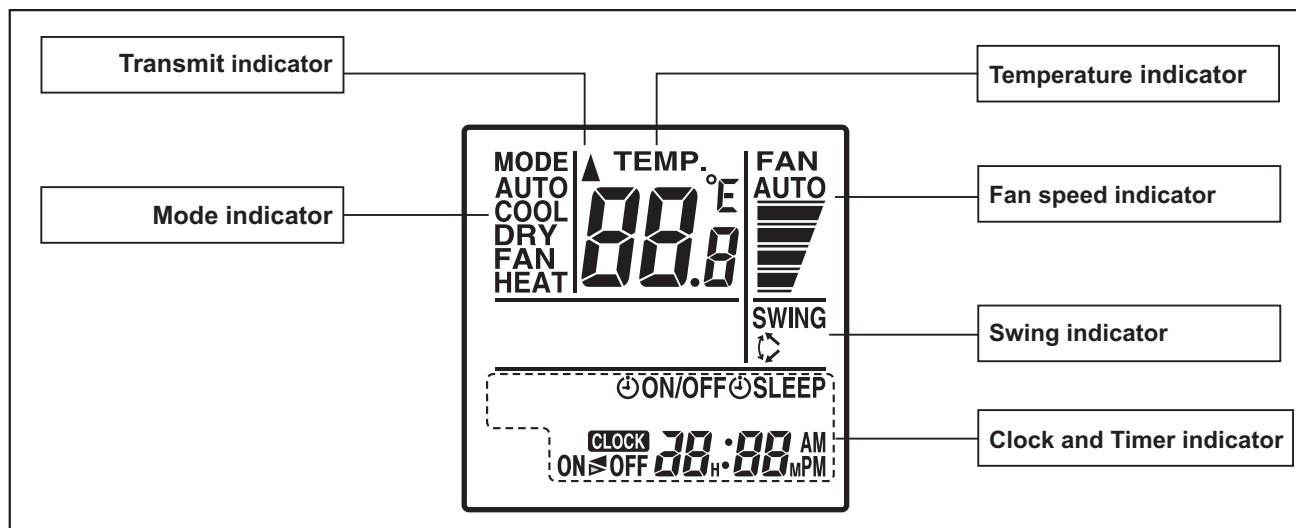

To facilitate explanation, the accompanying illustration has been drawn to show all possible indicators; in actual operation, however, the display will only show those indicators appropriate to the current operation.

■ Specifications

● Controller

Unit: mm

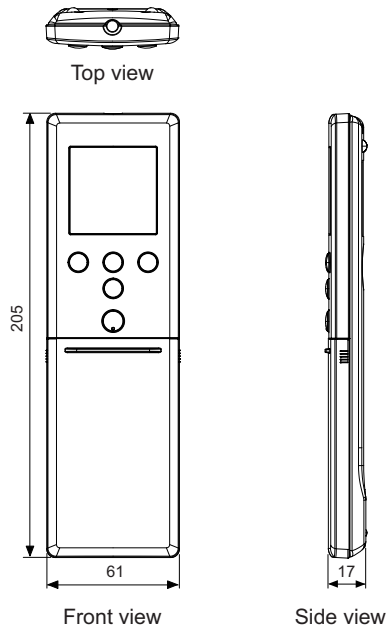

Size (H × W × D)	mm	205 × 61 × 17
Weight	g	122 (without batteries)

● Holder

Unit: mm

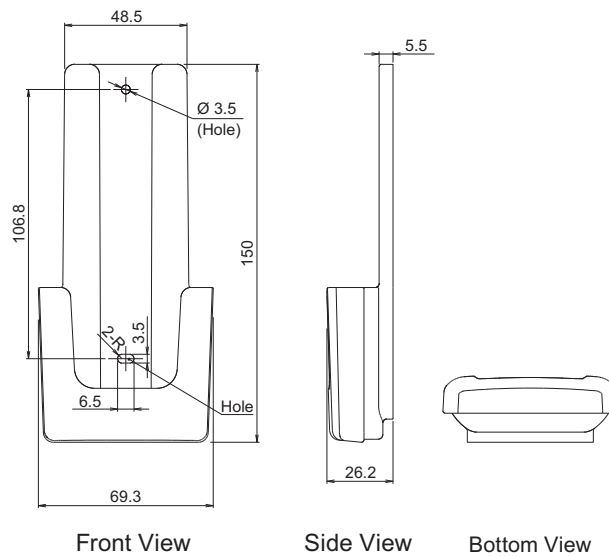

Size (H × W × D)	mm	150 × 69.3 × 26.2
Weight	g	27

● IR receiver

Unit: mm

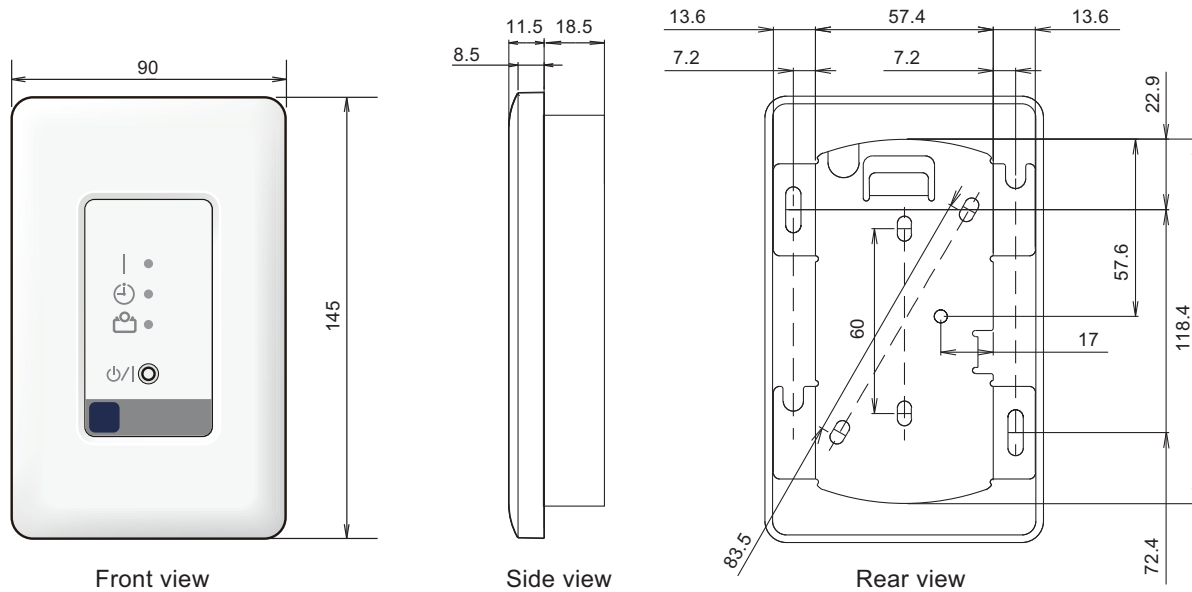

Size (H × W × D)	mm	145 × 90 × 30
Weight	g	150

13-5. Wired remote controller (UTY-RNNYM)



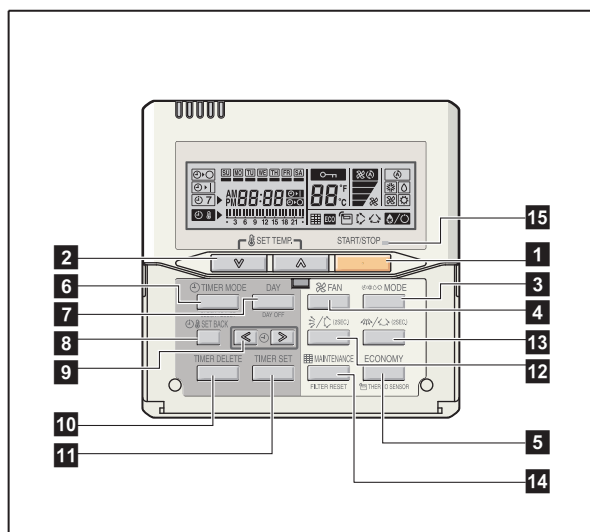



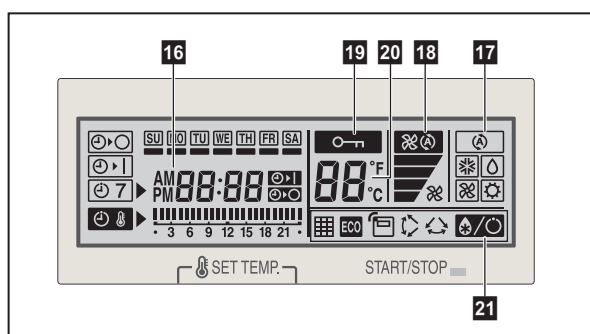









Overview



Display panel



NOTE: Functions may differ by type of the indoor unit. For details, refer to the operation manual.

- 1 START/STOP button**
Starts and stops operation.
- 2 SET TEMP. button**
Selects the setting temperature.
- 3 MODE button**
Selects the operating mode (AUTO , HEAT , FAN , COOL , and DRY ).
- 4 FAN button**
Selects the fan speed AUTO , QUIET , LOW , MED , and HIGH .
- 5 ECONOMY (THERMO SENSOR) button**
Turns the economy-efficient mode on and off.
- 6 TIMER MODE (CLOCK ADJUST) button**
Selects the timer mode (off timer, on timer, and weekly timer). Sets the current time.
- 7 DAY (DAY OFF) button**
Temporarily cancels one day timer.
- 8 SET BACK button**
Selects the set back timer.
- 9 Set time button**
Pressed to set time.
- 10 TIMER DELETE button**
Deletes the weekly timer schedule.
- 11 TIMER SET button**
Sets the date, hour, minute, and on-off time.
- 12 Vertical airflow direction and swing button**
Push for 2 seconds to change the swing mode.
- 13 Horizontal airflow direction and swing button**
Push for 2 seconds to change the swing mode.
- 14 FILTER RESET button**
- 15 Operation lamp**
Lights during operation and when the timer is on.
- 16 Timer and clock indicator**
- 17 Operation mode indicator**
- 18 Fan speed indicator**
- 19 Operation lock indicator**
- 20 Temperature indicator**
- 21 Function indicators**
 -  Defrost indicator
 -  Thermo sensor indicator
 -  Economy indicator
 -  Vertical swing indicator
 -  Horizontal swing indicator
 -  Filter indicator

System diagram

1 remote controller:

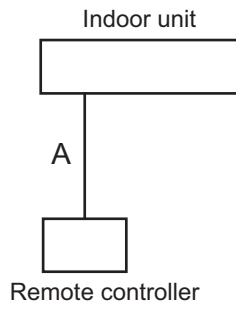

2 remote controllers:

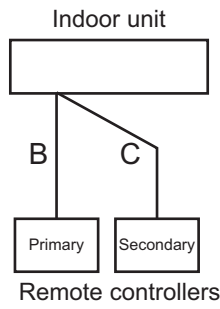

A, B, C: Remote controller cable
 $A \leq 500 \text{ m}; B + C \leq 500 \text{ m}$

Electrical wiring

1 remote controller:

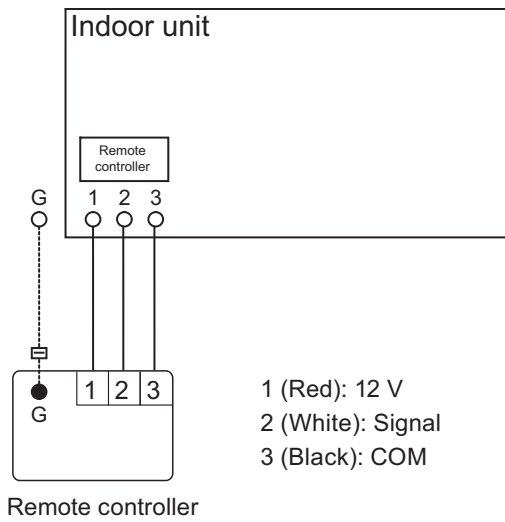

2 remote controllers:

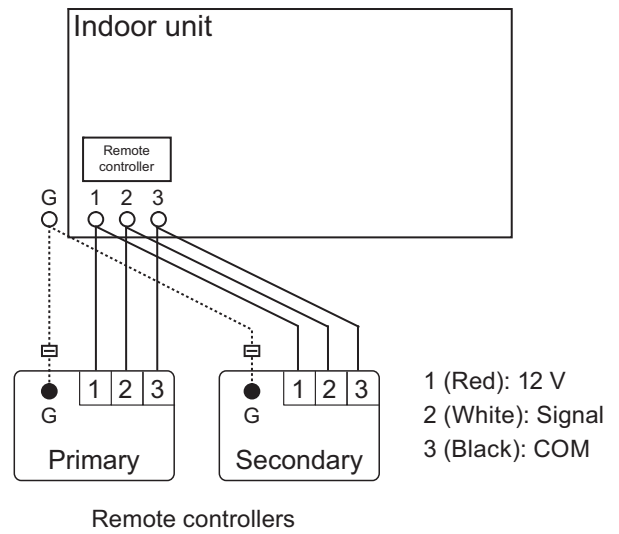

■ Specifications

Dimensions and other specifications on the wired remote controller are as follows.

		Unit: mm
Front view		Side view
Size (H × W × D)	mm	120 × 120 × 18
Weight	g	160
Cable length (accessory)	m	10
Power	V	12

● Wiring specifications

Use	Cable size	Wire type	Remarks
Remote controller cable	0.33 mm ² (22 AWG)	Polar 3-core	Use sheathed PVC cable.

■ Installation

● Connection pattern

NOTE: Connection pattern is different according to type of Indoor unit.

Indoor unit type		Connection pattern
Compact cassette		Pattern A
Slim duct, Mini duct		
Floor/Ceiling		Pattern B
Wall mounted	LU	
	LM	
Floor		Pattern C

● Pattern A

Connect the end of remote controller cable directly to the exclusive terminal block.

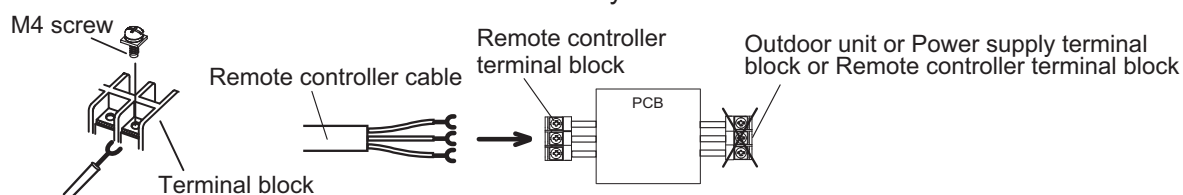

NOTE: It may be failed if it is connected to the outdoor unit or the terminal block for power supply.

● Pattern B

1. Modify the remote controller cable as follows:
 - Use a tool to cut off the terminal on the end of the remote controller cable and then remove the insulation from the cut end of the cable as shown in following figure.
 - Connect the remote controller cable and connecting cable as shown in following figure.
 - Be sure to insulate the connection between the cables.

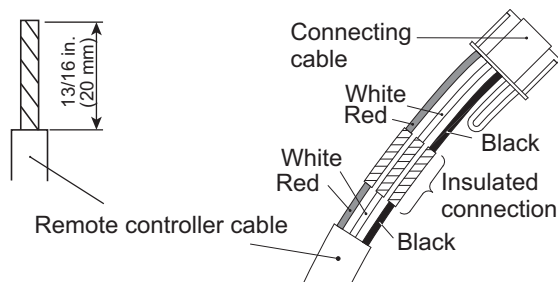

2. Connect the remote controller cable.
 - Connect the cable made in step 1. to the terminal (*1) of optional communication kit.
 - Connect the cable from the terminal (*2) of communication kit to the indoor unit PCB.

- *1: CNC01 (for LU type: UTY-TWBXF)
CNC01 (for LM type: UTY-XCBXZ2)
- *2: CND01 (for LU type: UTY-TWBXF)
CNC01 (for LM type: UTY-XCBXZ2)

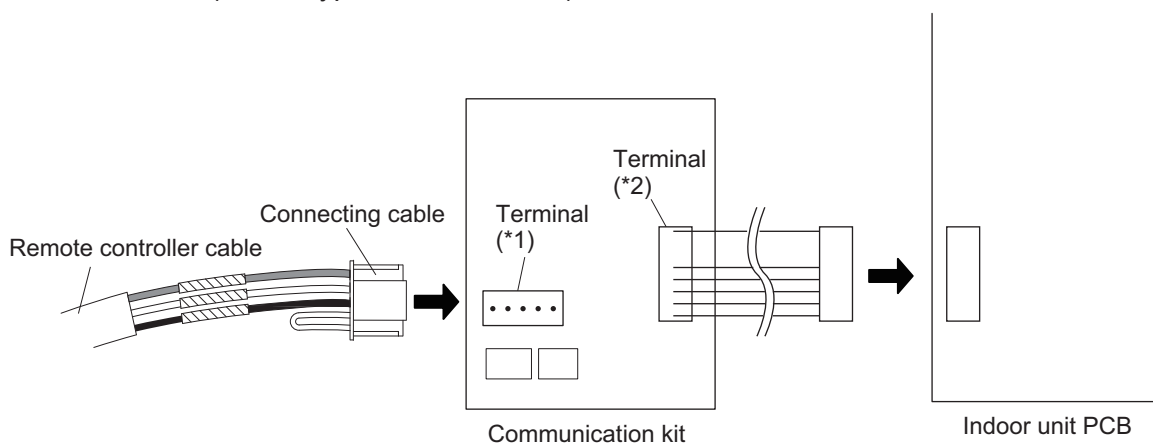

● Pattern C

1. Modify the remote controller cable as follows:
 - Use a tool to cut off the terminal on the end of the remote controller cable and then remove the insulation from the cut end of the cable as shown in following figure.
 - Connect the remote controller cable and connecting cable as shown in following figure.
 - Be sure to insulate the connection between the cables.

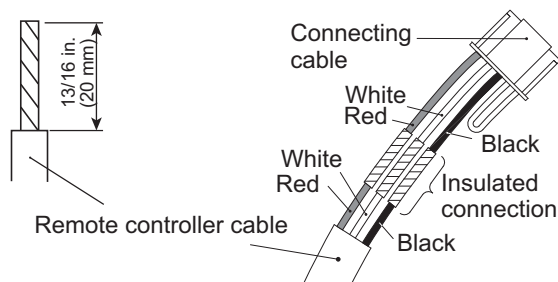

2. Connect the remote controller cable.
 - Connect the cable made in step 1. to the indoor unit PCB.

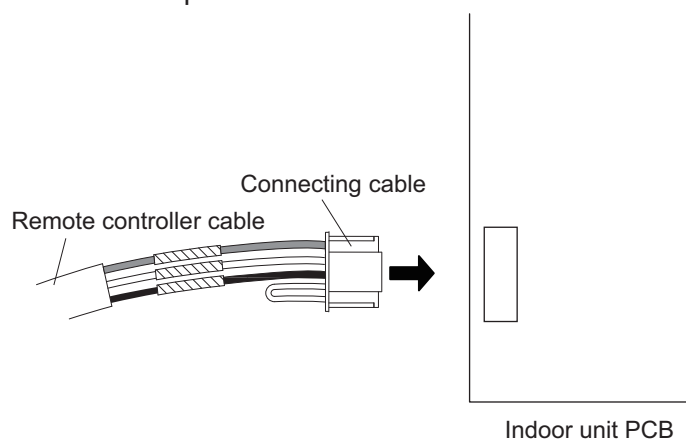

■ Optional parts

Wall mounted	Model name
LU	UTY-TWBXF
LM	UTY-XCBXZ2

The communication kit is needed for connecting the wired remote controller to the wall mounted type.

13-6. Wired remote controller (UTY-RLRY)

Overview

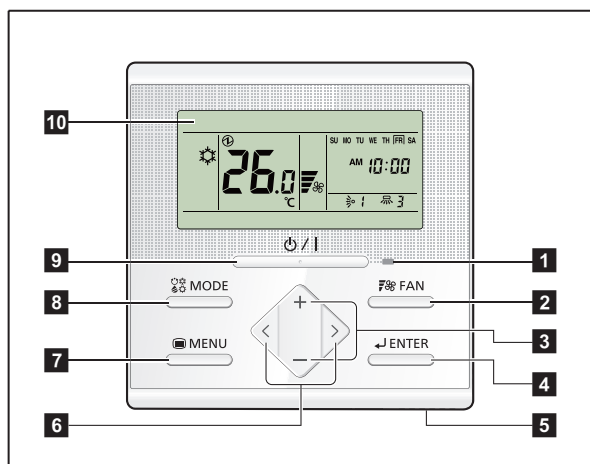

Display panel

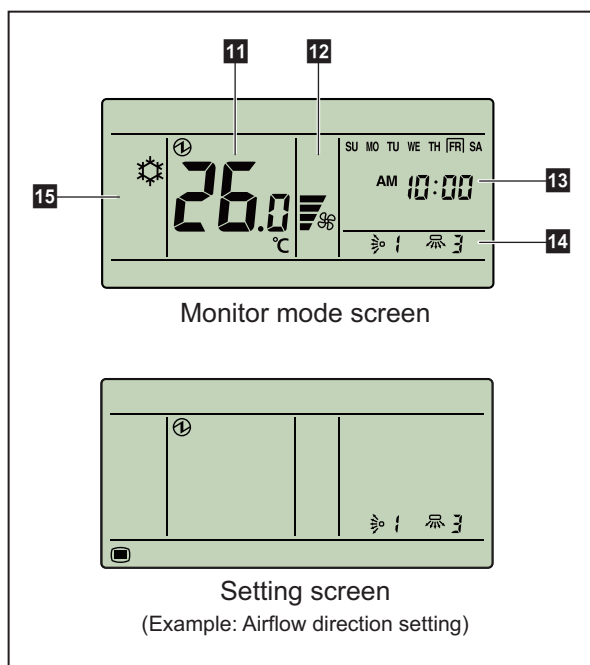

NOTE: For individual icons in Setting screen and related functions, refer to the operation manual.

1 LED lamp (Operation indicator)

Lights while the indoor unit is operating. Blinks when an error occurred.

2 FAN button

Each time the button is pressed, fan speed switches as follows:

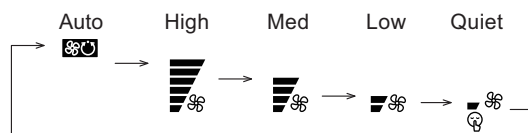

3 +, - buttons (Set temperature buttons)

Used to adjust temperature in Monitor mode screen.

+ button: Raise

- button: Lower

In Setting screen, used to select the setting items.

NOTE: When the operation mode is set to FAN, the temperature cannot be adjusted.

4 ENTER button

Used to enter setting items and settings.

5 Room temperature sensor (inside)

Senses ambient temperature of unit.

6 <, > buttons

Used to select setting items during the setting item selection screen is displayed.

7 MENU button

Used to display the setting item selection screen.

8 MODE button

Each time the button is pressed, operation mode switches as follows:



9 On/Off button

Starts or stops the operation.

NOTE: On/Off button cannot be operated at screens other than the Monitor mode screen.

10 Display panel

Displays Monitor mode screen or Setting screen. Monitor mode screen is home screen of this controller, and the basic operation is performed in this screen. In Setting screen, several settings are adjustable.

11 Temperature indicator

12 Fan speed indicator

13 Clock indicator

14 Airflow direction indicator

15 Operation mode indicator

System diagram

1 remote controller:

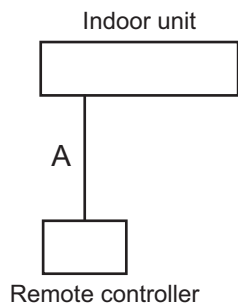

2 remote controllers:

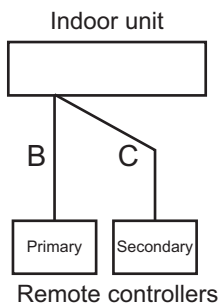

A, B, C: Remote controller cable
 $A \leq 500 \text{ m}; B + C \leq 500 \text{ m}$

Electrical wiring

1 remote controller:

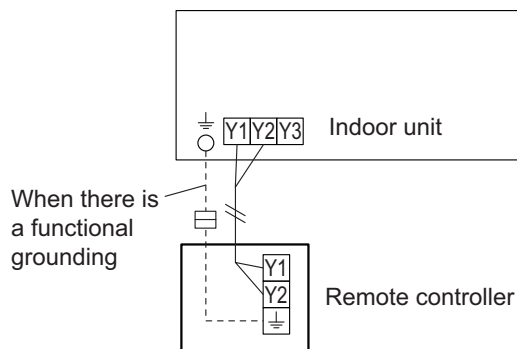

2 remote controllers:

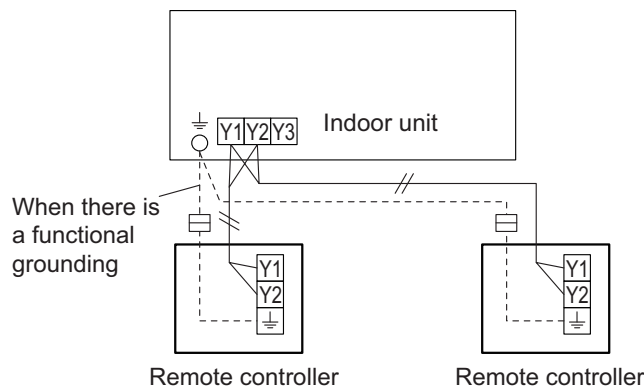

Group control:

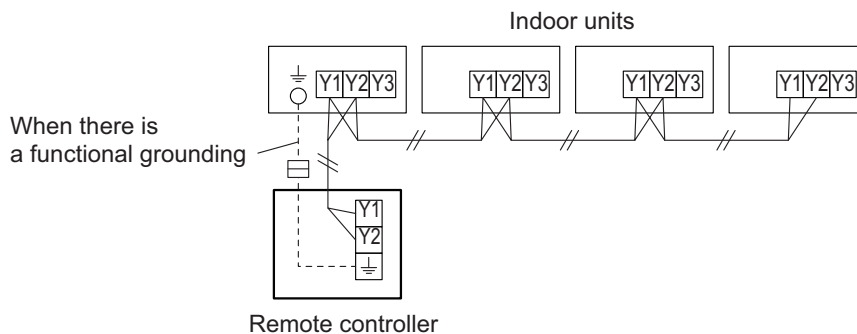

NOTE: Group connection with Polar 3-wired remote controller is not allowed.

Specifications

Dimensions and other specifications on the wired remote controller are as follows.

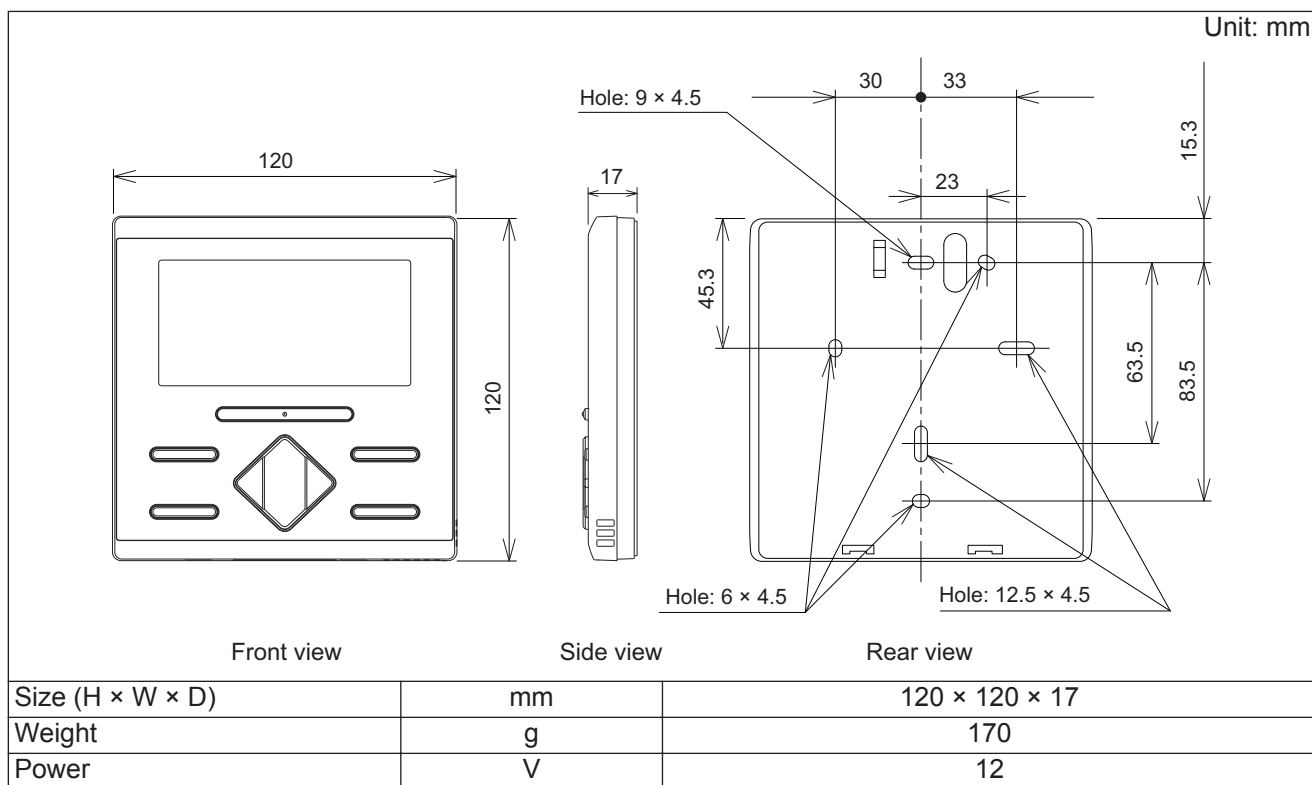

Wiring specifications

Use	Cable size	Wire type	Remarks
Remote controller cable	0.33 to 1.25 mm ²	Non-polar 2-core, Twisted pair	Use sheathed PVC cable.

Installation

Connect the end of remote controller cable directly to the exclusive terminal block.

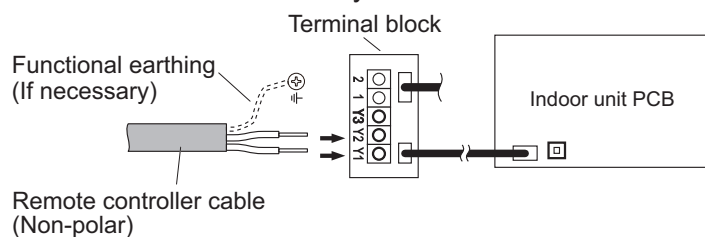

NOTES:

- Layout of terminal block and PCB varies depending on the type of indoor unit.
- Operation may fail if it is connected to the outdoor unit or the terminal block for power supply.

13-7. Wired remote controller (UTY-RVNYM: Optional part)

■ Overview

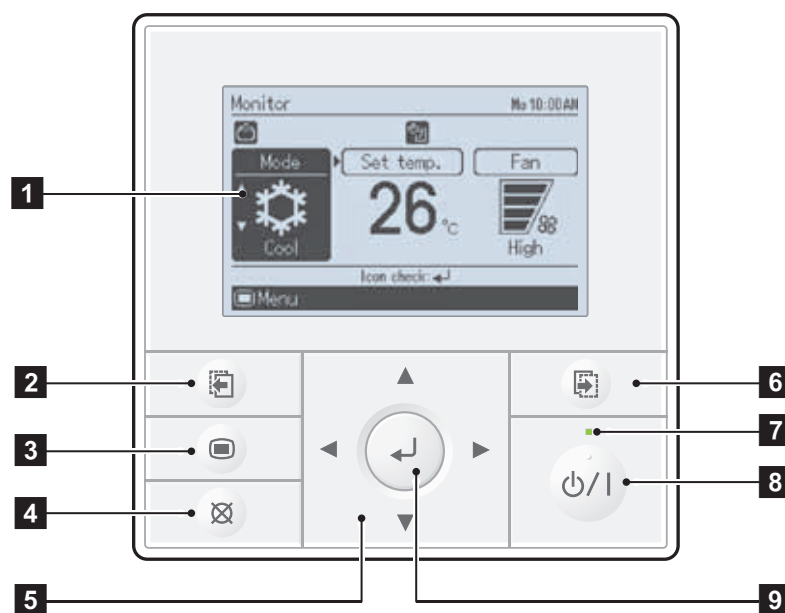

- 1** Display panel (with backlight)
- 2** Screen switch button (Left)
- 3** Menu button
- 4** Cancel button
- 5** Cursor button
- 6** Screen switch button (Right)
- 7** Power indicator
- 8** On/off button
- 9** Enter button

System diagram

1 remote controller:

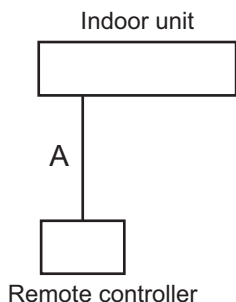

2 remote controllers:

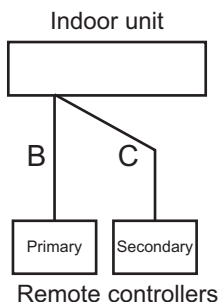

A, B, C: Remote controller cable
 $A \leq 500 \text{ m}; B + C \leq 500 \text{ m}$

Electrical wiring

1 remote controller:

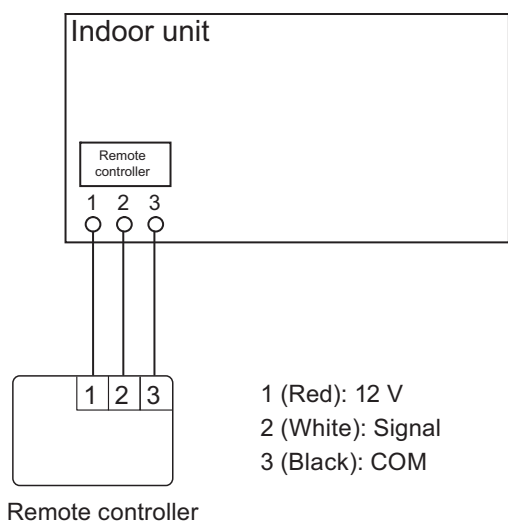

2 remote controllers:

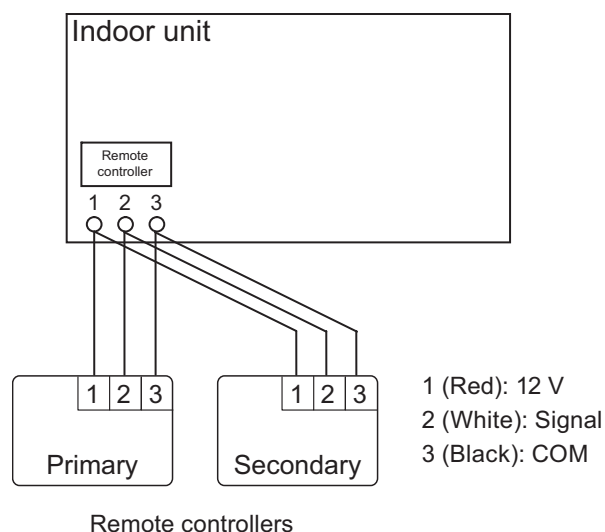

Controller combination

As for the combined usage of the controller, refer to following figures.

● Good

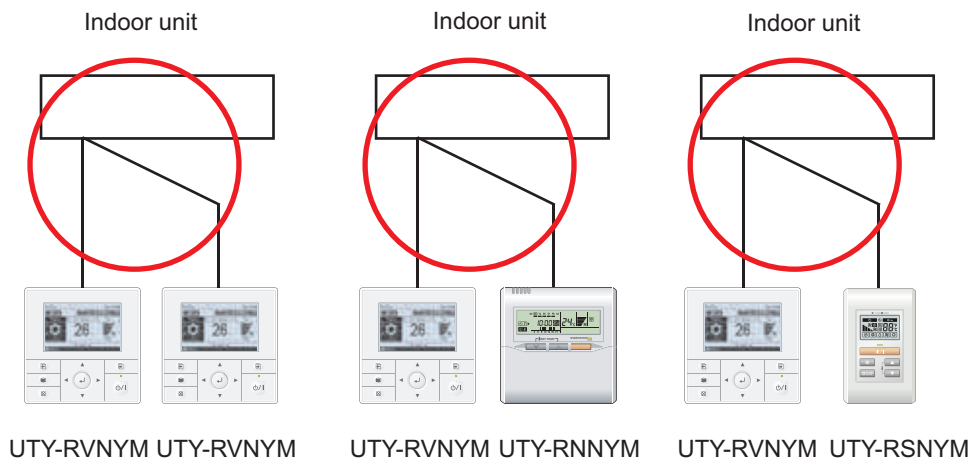

■ Specifications

Unit: mm

Size (H × W × D)	mm	120 × 120 × 21.3
Weight	g	220

● Wiring specifications

Use	Cable size	Wire type	Remarks
Remote controller cable	0.33 mm ²	Polar 3 core	Use sheathed PVC cable.

■ Installation (Remote control main unit)

Installation space:

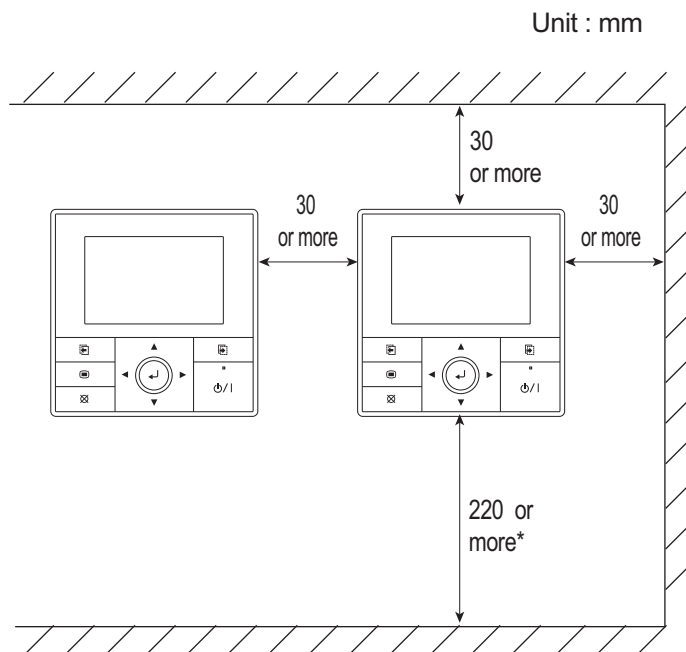

NOTE: Secure enough space where a flat-blade screwdriver to remove the case can be inserted.

Installation procedures:

1. Process the remote controller cable.

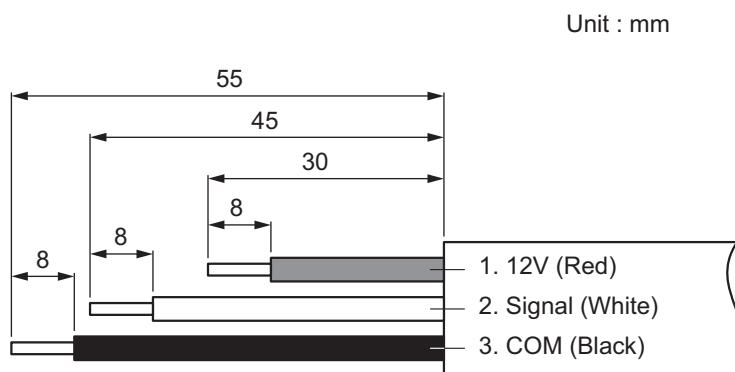

2. Insert the flat-blade screwdriver and twist it slightly to separate the front case and rear case.

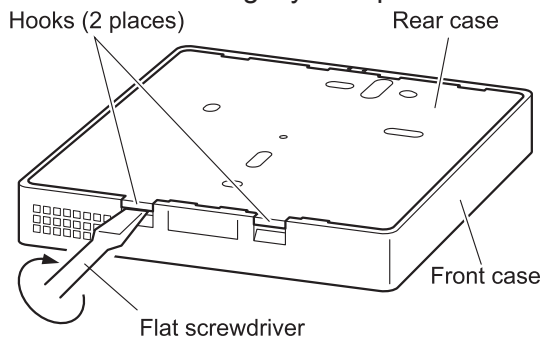

3. Attach the remote controller.

• When attaching to switch box:

- Seal the wiring hole of the remote controller cable.
- Put a remote controller cable through the hole of the rear case.
- Fix the rear case by securing it with attached screws (2 places).

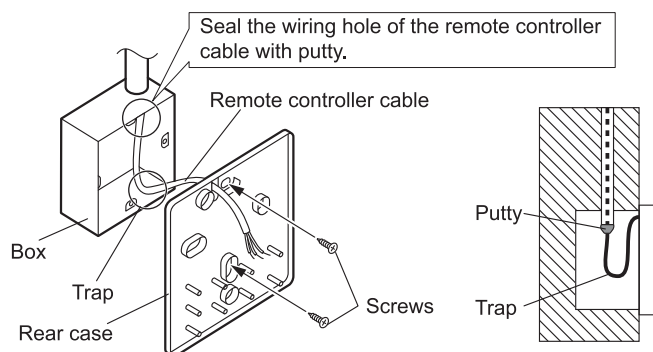

• When attaching to the wall directly:

- Seal the wiring hole of the remote controller cable.
- Put a remote controller cable through the back hole of the rear case of the main body.
- Fix the rear case by securing it with attached screws (2 places).

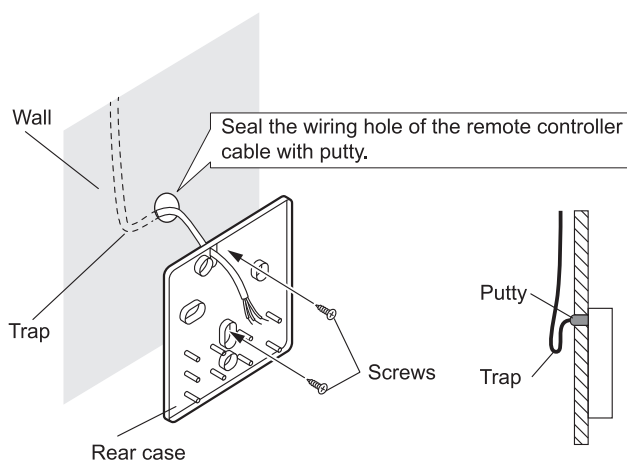

• When routing the cable on-wall:

- Cut off the cable guide of the front case with using a knife or a nipper.
- Deburr the edge of the cable guide.

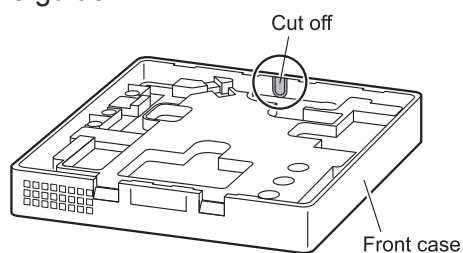

- Fix the rear case by securing it with attached screws (2 places).

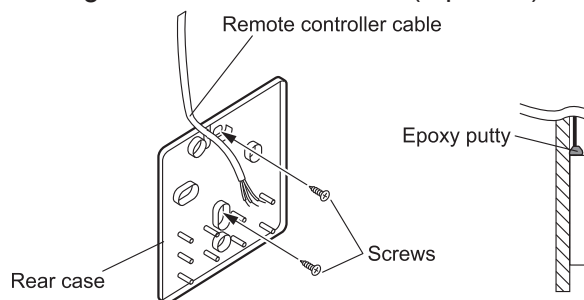

4. Connect the cable to the terminals on the front case.
Fix the cable together with the sheath with the cable tie. Cut off the excess cable tie.

Tightening torque	
Terminal screw	0.8 to 1.2 N•m

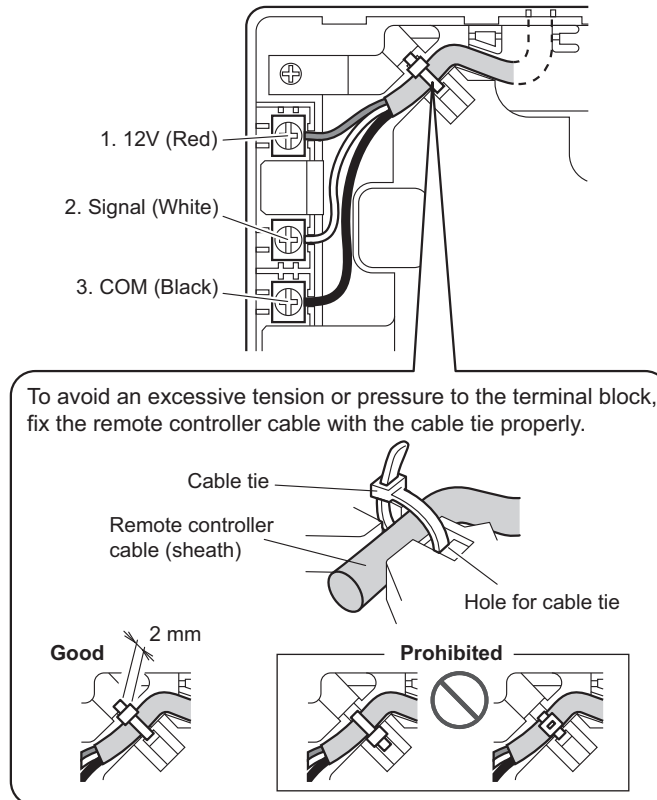

⚠ CAUTION

- Be careful to avoid breaking the cable by over-tightening the cable tie.
- When connecting the remote controller cables, do not over-tighten the screws.

5. Attach the front case.
- Insert after adjusting upper part of front case.
 - When insert the front case, do not pinch the cable.

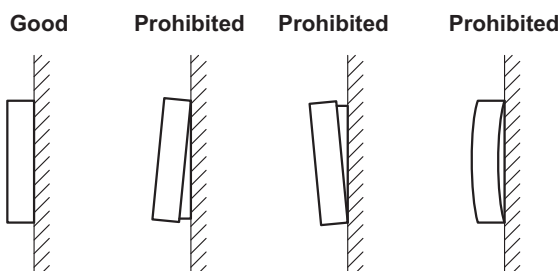
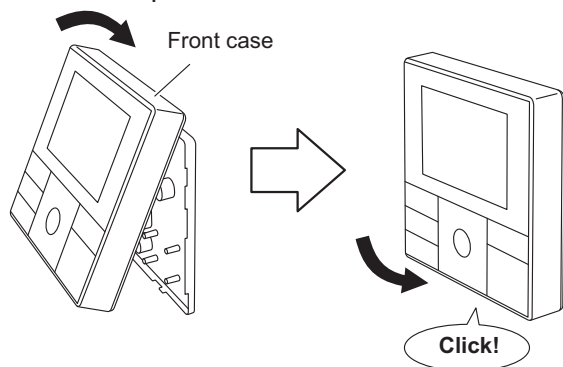

⚠ CAUTION

Insert the upper case firmly. If improperly attached, it will cause the upper case to fall off.

■ Installation

● Connection pattern

NOTE: Connection pattern is different according to type of Indoor unit.

Indoor unit type		Connection pattern
Compact cassette		Pattern A
Slim duct, Mini duct		
Floor/Ceiling		
Wall mounted	LU	Pattern B
	LM	
	LF	
Floor		Pattern C

● Pattern A

Connect the end of remote controller cable directly to the exclusive terminal block.

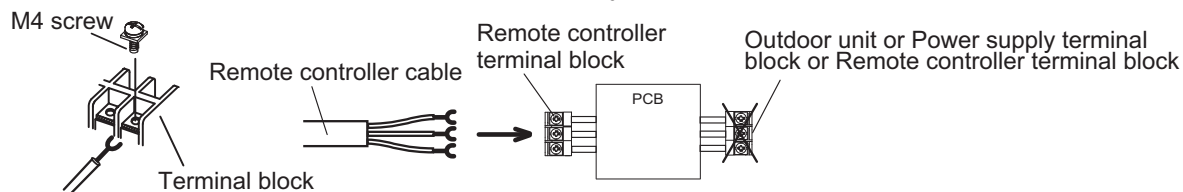

NOTE: It may be failed if it is connected to the outdoor unit or the terminal block for power supply.

● Pattern B

1. Modify the remote controller cable as follows:
 - Use a tool to cut off the terminal on the end of the remote controller cable and then remove the insulation from the cut end of the cable as shown in following figure.
 - Connect the remote controller cable and connecting cable as shown in following figure.
 - Be sure to insulate the connection between the cables.

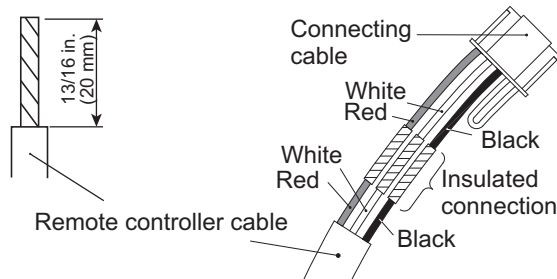

2. Connect the remote controller cable.
 - Connect the cable made in step 1. to the terminal (*1) of optional communication kit.
 - Connect the cable from the terminal (*2) of communication kit to the indoor unit PCB.

*1: CNC01 (for LU type: UTY-TWBXF)
CNC01 (for LM type: UTY-XCBXZ2)

*2: CND01 (for LU type: UTY-TWBXF)
CNC01 (for LM type: UTY-XCBXZ2)

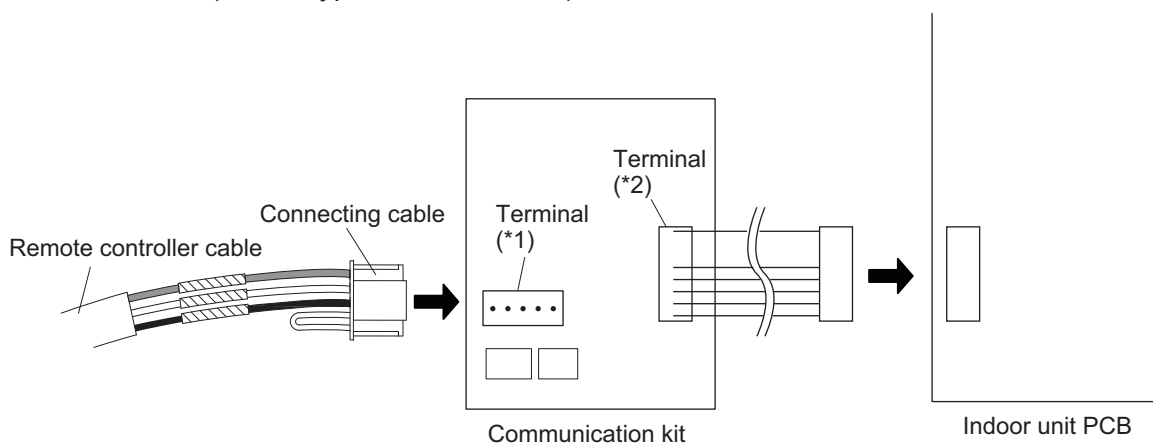

● Pattern C

1. Modify the remote controller cable as follows:
 - Use a tool to cut off the terminal on the end of the remote controller cable and then remove the insulation from the cut end of the cable as shown in following figure.
 - Connect the remote controller cable and connecting cable as shown in following figure.
 - Be sure to insulate the connection between the cables.

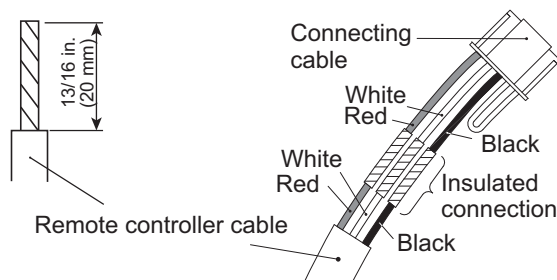

2. Connect the remote controller cable.
 - Connect the cable made in step 1. to the indoor unit PCB.

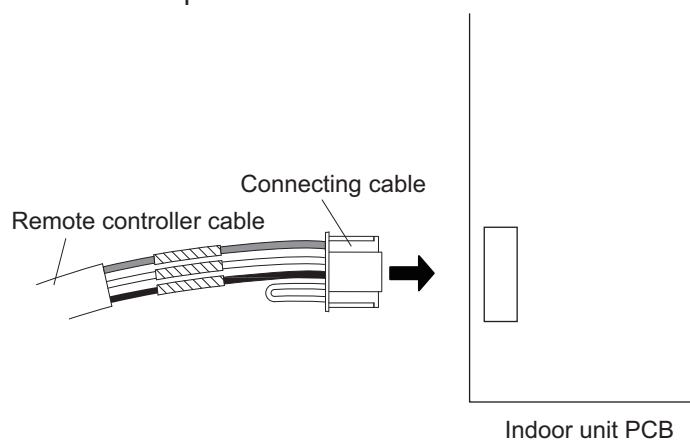

■ Optional parts

Wall mounted	Model name
LU	UTY-TWBXF
LM	UTY-XCBXZ2

The communication kit is needed for connecting the wired remote controller to the wall mounted type.

13-8. Wired remote controller (UTY-RNRYZ*: Optional part)

Overview

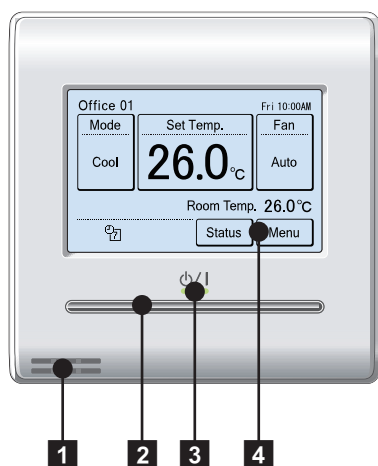

Display panel

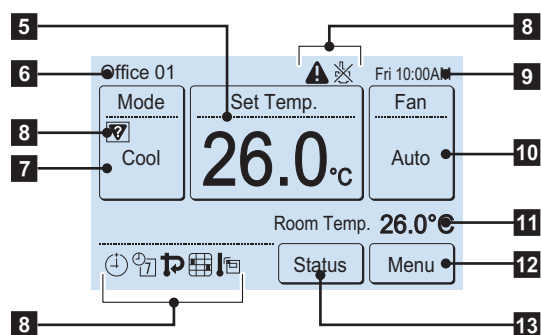

- 1 Remote temperature sensor (inside)**
- 2 On/off button**
Operable only while displaying the "Monitor mode" screen.
- 3 LED lamp (operation indicator)**
- 4 Touch panel display**
- 5 Set temperature**
Operating temperature can be set.
- 6 Remote controller group name**
- 7 Mode**
Operation mode can be set.
- 8 Status icons**
- 9 Clock**
- 10 Fan**
Fan speed can be set.
- 11 Room temperature**
- 12 Menu**
Various settings can be set.
- 13 Status**
Status of the indoor unit and error can be checked.

NOTE: Functions may differ by type of the indoor unit. For details, refer to the operation manual.

System diagram

1 remote controller:

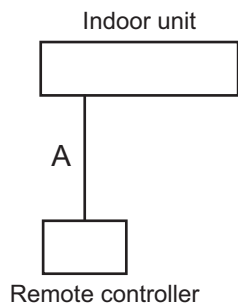

2 remote controllers:

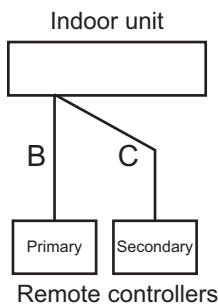

A, B, C: Remote controller cable
 $A \leq 500 \text{ m}; B + C \leq 500 \text{ m}$

Electrical wiring

1 remote controller:

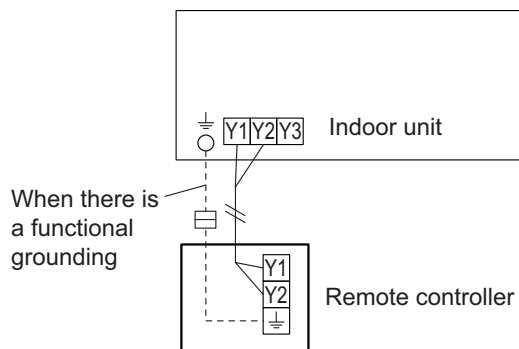

2 remote controllers:

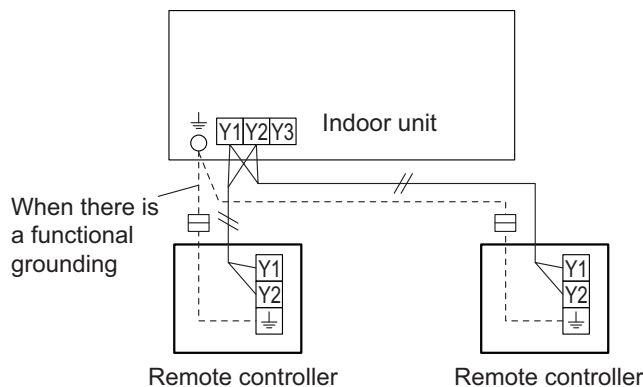

Group control:

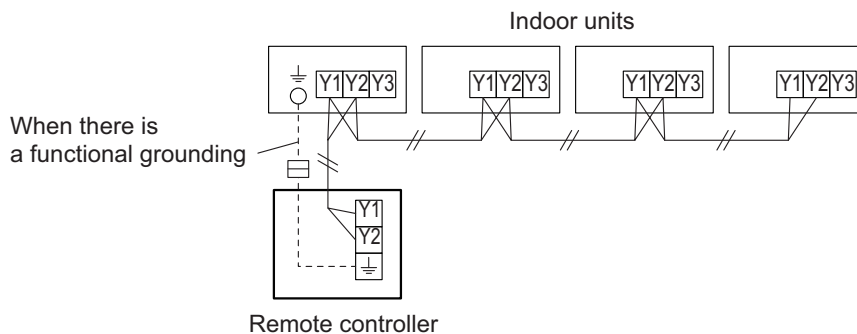

NOTE: Group connection with Polar 3-wired remote controller is not allowed.

■ Specifications

Dimensions and other specifications on the wired remote controller are as follows.

[Unit : mm]

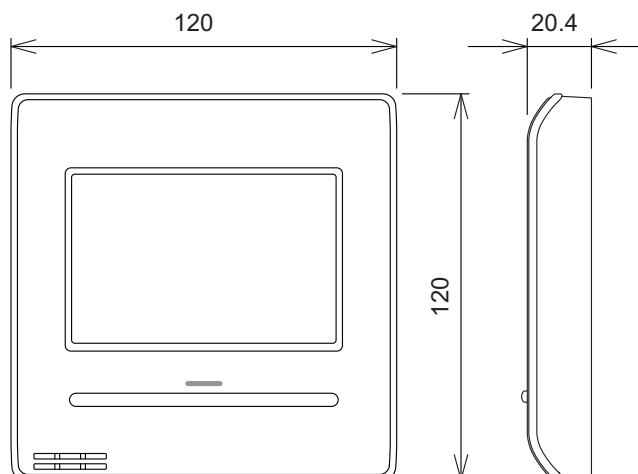

Model name	UTY-RNRYZ*	
Display	3.8-inch FSTN LCD (255 × 160 dots) with touch panel	
Dimensions (H × W × D)	mm	120 × 120 × 20.4
Weight	g	220
Input voltage	V	DC 12
Power consumption	W	Max. 0.3
Usage temperature range	°C	0 to 40
Usage humidity range	%	20 to 90 (no condensation)
Storage temperature range	°C	-10 to 60
Storage humidity range	%	20 to 90 (no condensation)

● Wiring specifications

Use	Cable size	Wire type	Remarks
Remote controller cable	0.33 to 1.25 mm ²	Non-polar 2-core, Twisted pair	Use sheathed PVC cable.

■ Installation

Connect the end of remote controller cable directly to the exclusive terminal block.

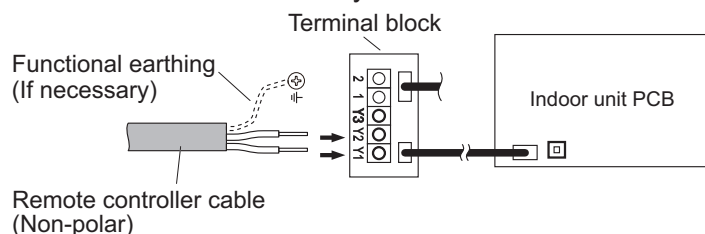

NOTES:

- Layout of terminal block and PCB varies depending on the type of indoor unit.
- Operation may fail if it is connected to the outdoor unit or the terminal block for power supply.

13-9. Simple remote controller (UTY-RSNYM: Optional part)

Overview

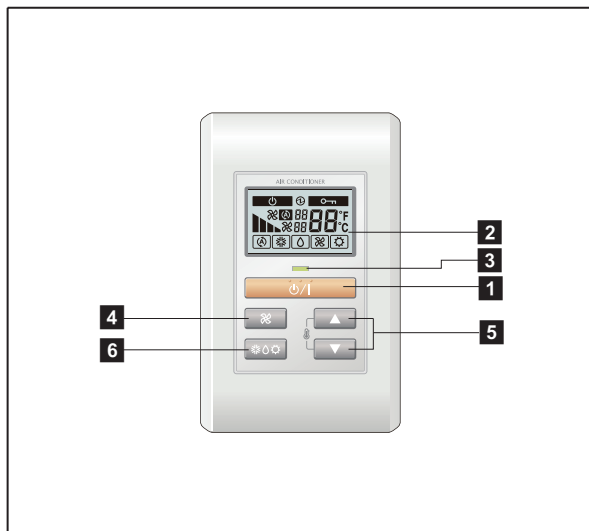

Display panel

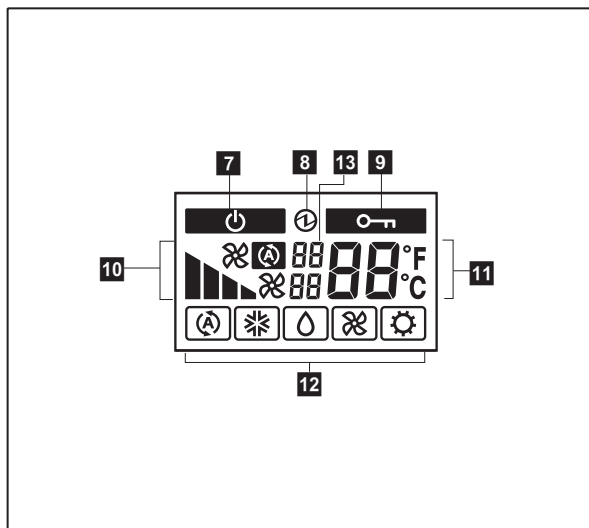

1 START/STOP button

Starts and stops operation.





2 Display backlight button

Lights during operation.

3 Operation lamp

Lights during operation.





4 FAN button

Selects the fan speed (AUTO , HIGH , MED , LOW , and QUIET ).

5 SET TEMP. button

Selects the setting temperature.

6 MODE button

Selects the operating mode (AUTO , COOL , DRY , FAN , HEAT ).

7 Standby indicator

Indicates during the oil recovery and defrosting operation.

8 Power source indicator

Indicates the main power is on.

9 Central control indicator

Indicates when function is locked.

10 Fan speed indicator

Deletes the weekly timer schedule.

11 Set temperature

- Indicates error history number in error code history display mode.
- Indicates indoor unit address in address display mode.

12 Operating mode indicator

13 Indicator

- Upper:
 - Indicates the error code in error code history display mode and in self diagnosis mode.
 - Indicates the refrigerant system address in address display mode.
- Lower: Indicates the remote controller address in error code history display mode, address display mode, and self diagnosis mode.

System diagram

1 remote controller:

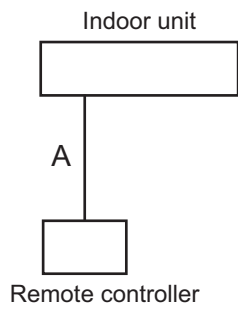

2 remote controllers:

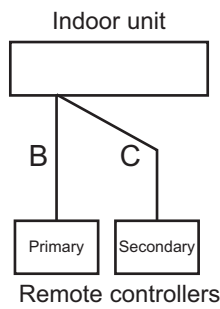

A, B, C: Remote controller cable
 $A \leq 500 \text{ m}; B + C \leq 500 \text{ m}$

Electrical wiring

1 remote controller:

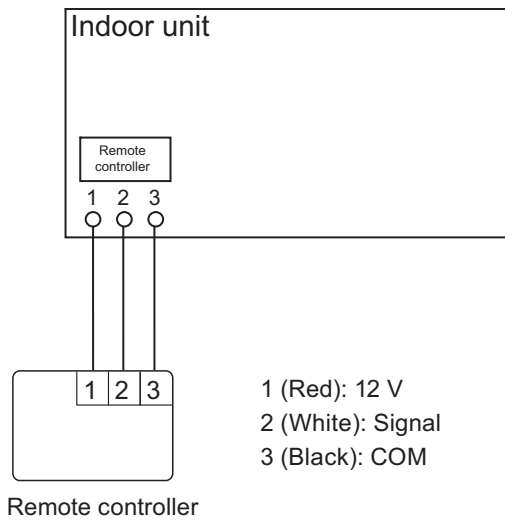

2 remote controllers:

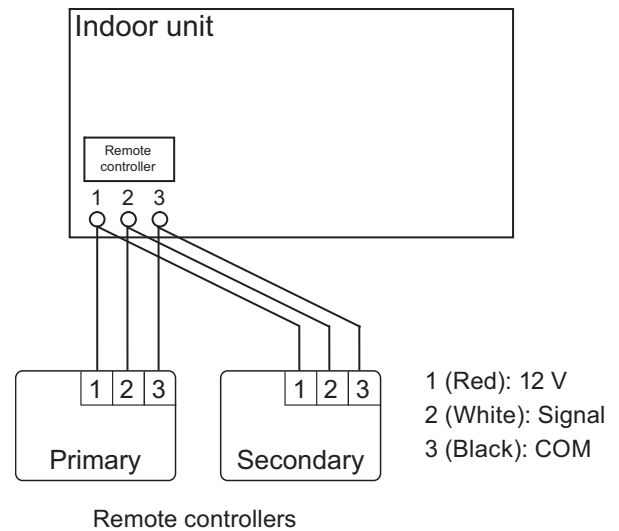

■ Specifications

Dimensions and other specifications on the wired remote controller are as follows.

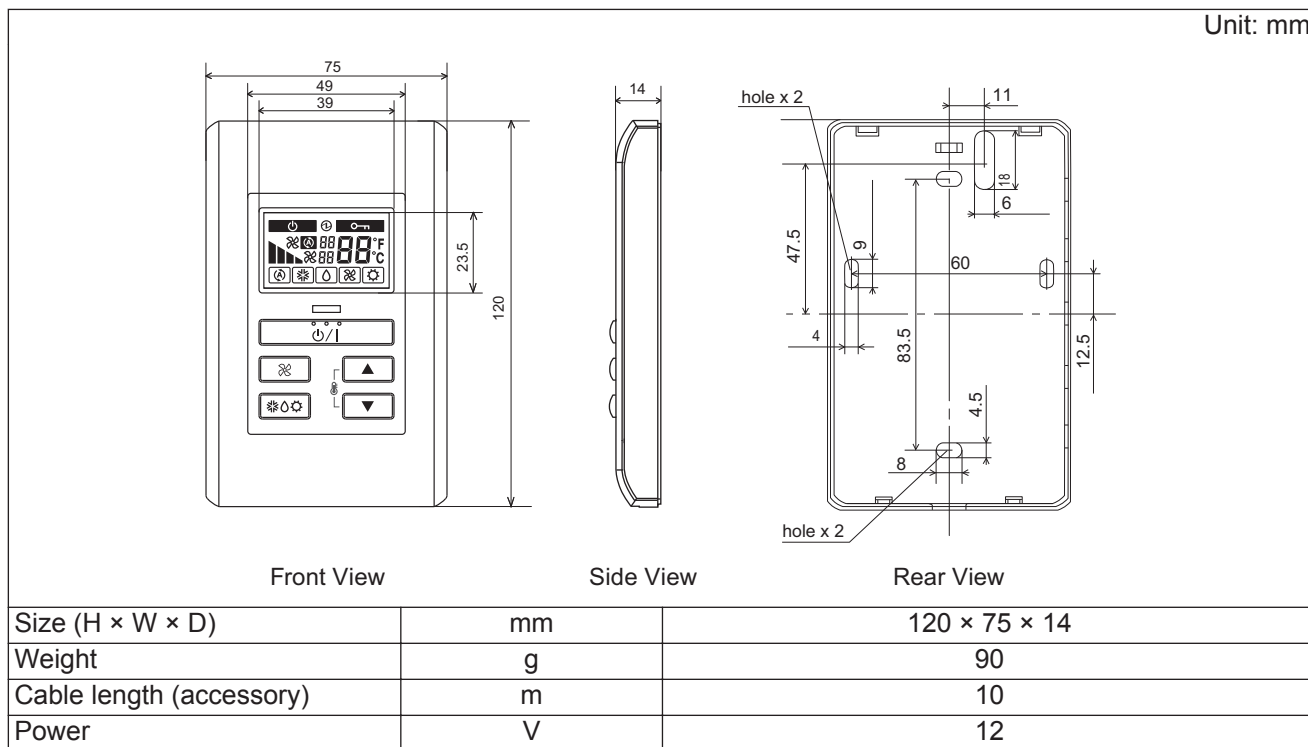

● Wiring specifications

Use	Size	Wire type	Remarks
Remote controller cable	0.33 mm ²	Polar 3 core	Use sheathed PVC cable.

■ Installation

● Connection pattern

NOTE: Connection pattern is different according to type of Indoor unit.

Indoor unit type		Connection pattern
Compact cassette		Pattern A
Slim duct, Mini duct		
Floor/Ceiling		
Wall mounted	LU	Pattern B
	LM	
	LF	
Floor		Pattern C

● Pattern A

Connect the end of remote controller cable directly to the exclusive terminal block.

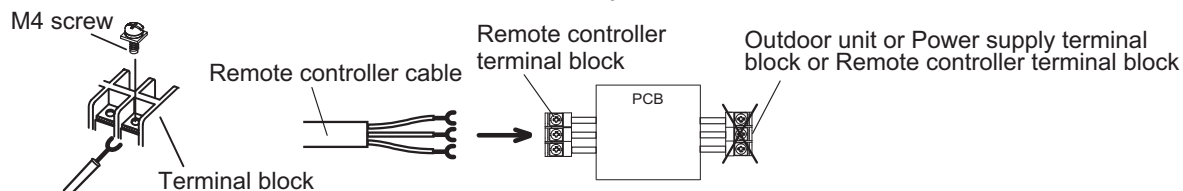

NOTE: It may be failed if it is connected to the outdoor unit or the terminal block for power supply.

● Pattern B

1. Modify the remote controller cable as follows:
 - Use a tool to cut off the terminal on the end of the remote controller cable and then remove the insulation from the cut end of the cable as shown in following figure.
 - Connect the remote controller cable and connecting cable as shown in following figure.
 - Be sure to insulate the connection between the cables.

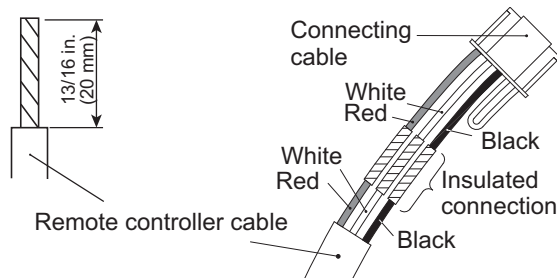

2. Connect the remote controller cable.
 - Connect the cable made in step 1. to the terminal (*1) of optional communication kit.
 - Connect the cable from the terminal (*2) of communication kit to the indoor unit PCB.

- *1: CNC01 (for LU type: UTY-TWBXF)
CNC01 (for LM type: UTY-XCBXZ2)
- *2: CND01 (for LU type: UTY-TWBXF)
CNC01 (for LM type: UTY-XCBXZ2)

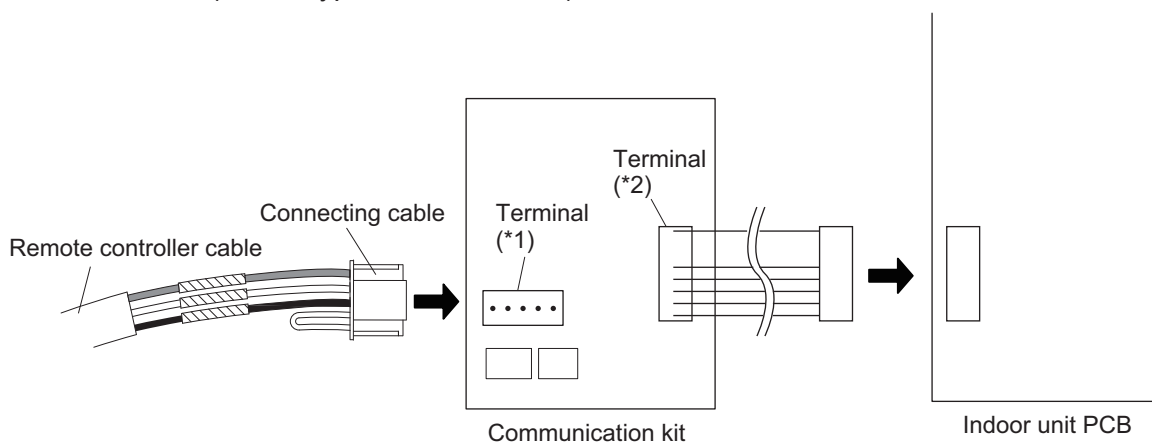

● Pattern C

1. Modify the remote controller cable as follows:
 - Use a tool to cut off the terminal on the end of the remote controller cable and then remove the insulation from the cut end of the cable as shown in following figure.
 - Connect the remote controller cable and connecting cable as shown in following figure.
 - Be sure to insulate the connection between the cables.

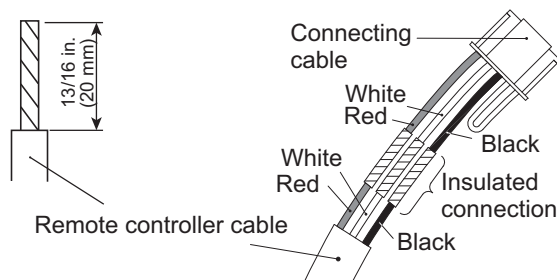

2. Connect the remote controller cable.
 - Connect the cable made in step 1. to the indoor unit PCB.

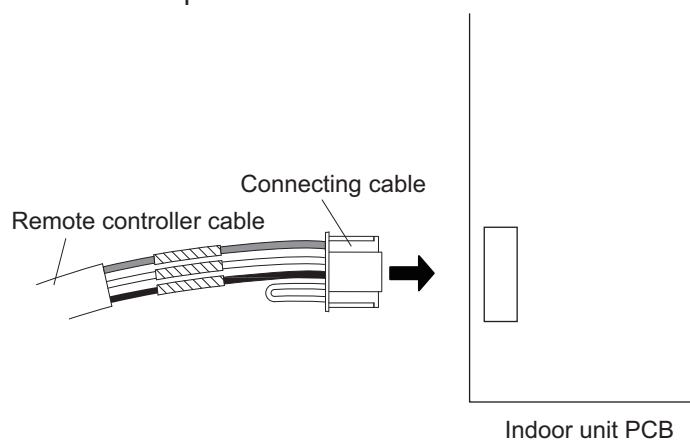

■ Optional parts

Wall mounted	Model name
LU	UTY-TWBXF
LM	UTY-XCBXZ2

The communication kit is needed for connecting the wired remote controller to the wall mounted type.

13-10. Simple remote controller (UTY-RSRY and UTY-RHRY: Optional parts)

Overview

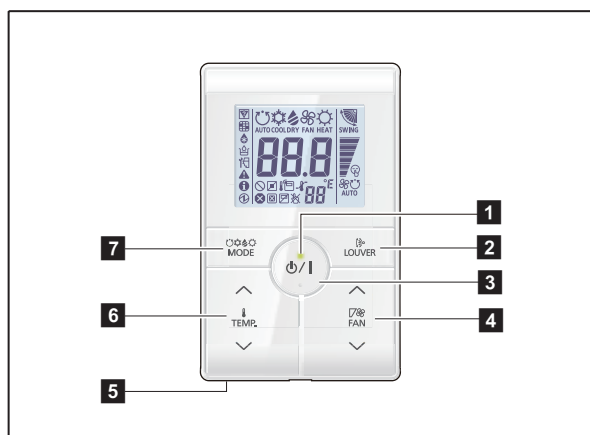

Display panel

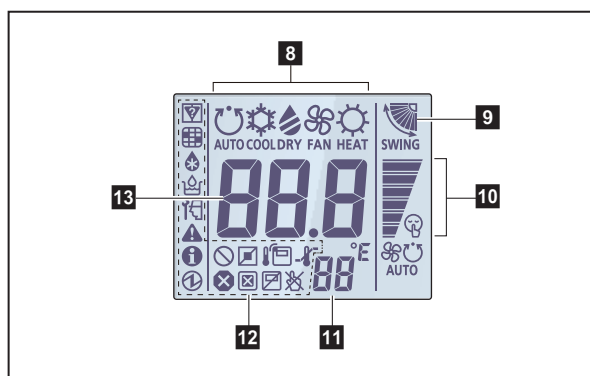

1: Available only for UTY-RSR.

*2: Not available for a heat pump model unless it is set up as an administrative indoor unit.

*3: Not available for a heat pump model.

*4: Not available for a cooling-only model.

*5: Set the function setting of the indoor unit accordingly.

*6: During address display mode.

1 LED lamp

Lights during operation.

2 Louver button

Adjusts the airflow direction.

3 START/STOP button

Starts and stops operation.

4 FAN control button

Each time the button is pressed, fan speed switches as follows:

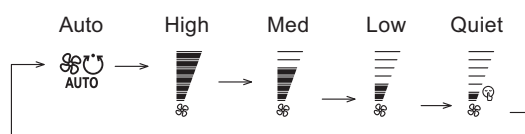

5 Room temperature sensor (inside)

Senses ambient temperature of unit.

6 Set temperature button

Selects the setting temperature. (18—30 °C [COOL], 10—30 °C [HEAT])

7 Operation mode button*1

Each time the button is pressed, operation mode switches as follows:



8 Operating mode indicator

9 Airflow direction indicator

10 FAN speed indicator

11 Remote controller address indicator

12 Status icons

- Mode mismatch
- Filter sign *5
- Defrost operation
- Oil recovery operation
- Under maintenance
- Error
- Special state
- Conducting electricity
- Emergency stop
- Operation controlled
- Forced stop
- Remote controller sensor is enabled *5
- Central controlled
- Setting temperature range is enabled
- Operation prohibited

13 Set temperature

Indicates indoor unit address. *6

System diagram

1 remote controller:

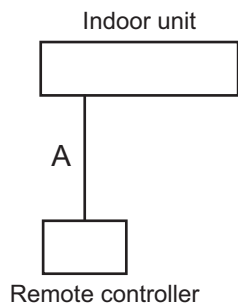

2 remote controllers:

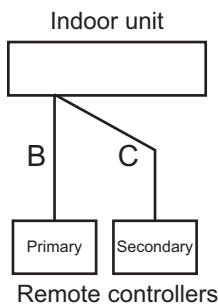

A, B, C: Remote controller cable
 $A \leq 500 \text{ m}; B + C \leq 500 \text{ m}$

Electrical wiring

1 remote controller:

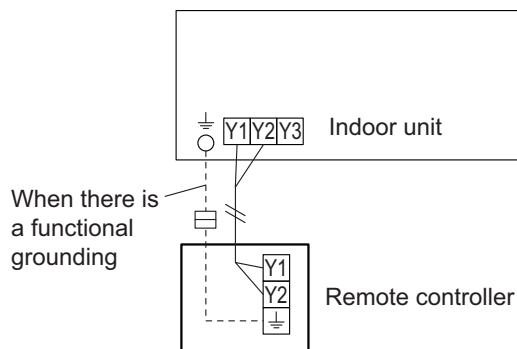

2 remote controllers:

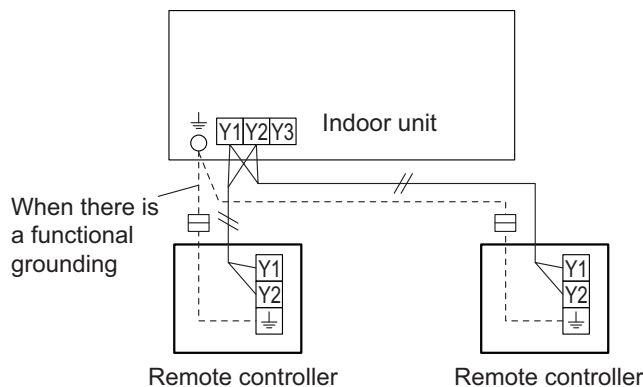

Group control:

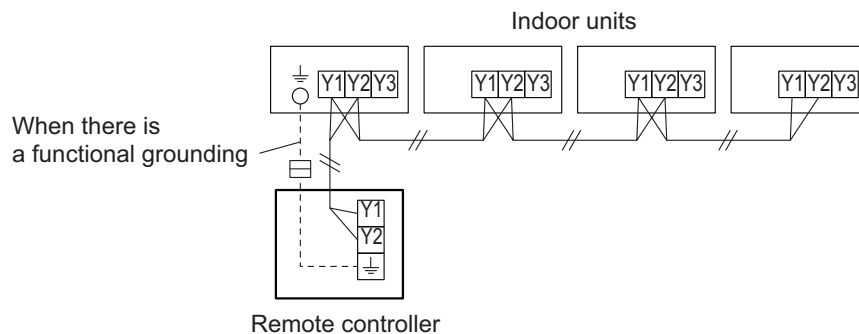

NOTE: Group connection with Polar 3-wired remote controller is not allowed.

Specifications

Dimensions and other specifications on the wired remote controller are as follows.

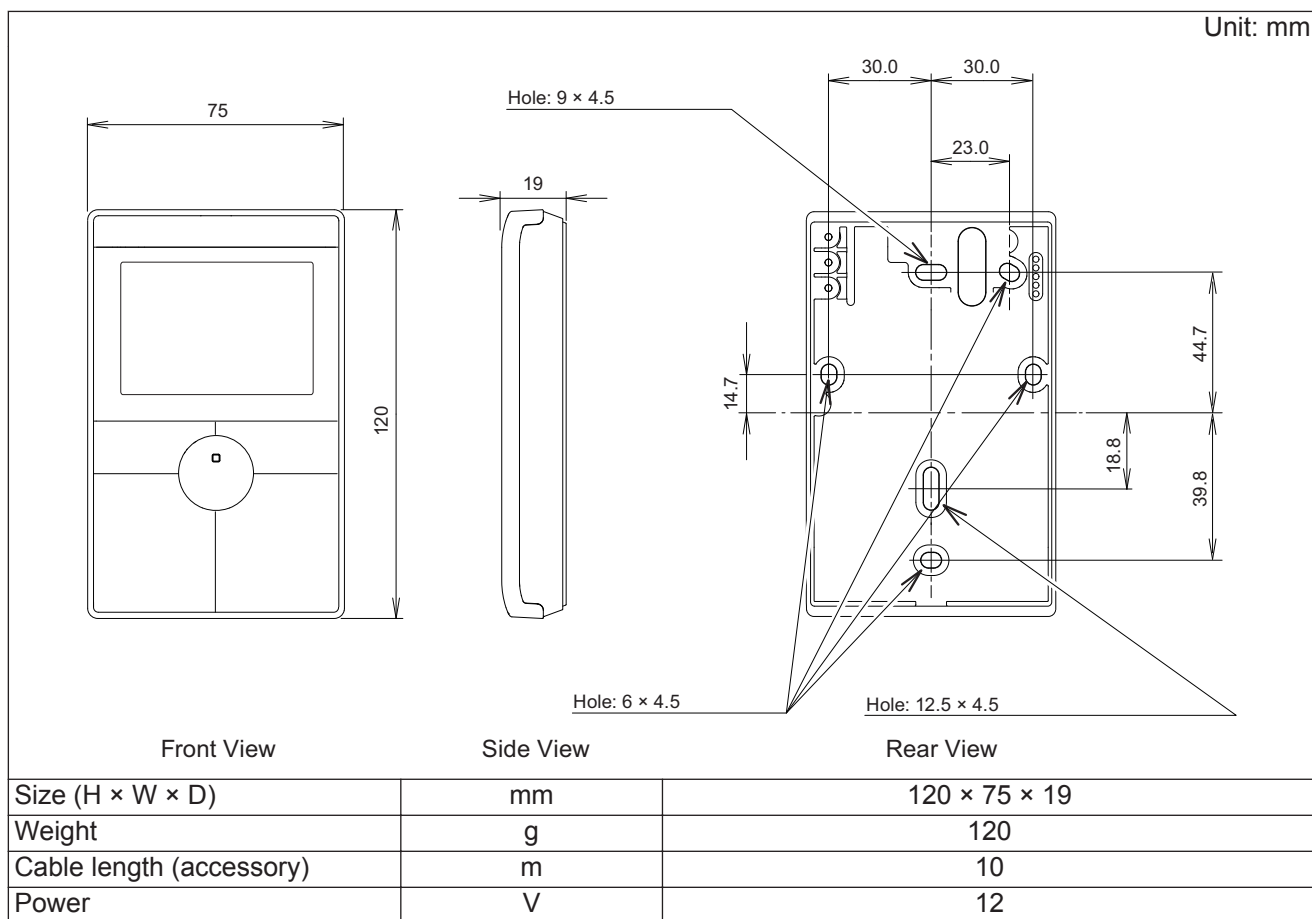

Wiring specifications

Use	Cable size	Wire type	Remarks
Remote controller cable	0.33 to 1.25 mm ²	Non-polar 2-core, Twisted pair	Use sheathed PVC cable.

Installation

Connect the end of remote controller cable directly to the exclusive terminal block.

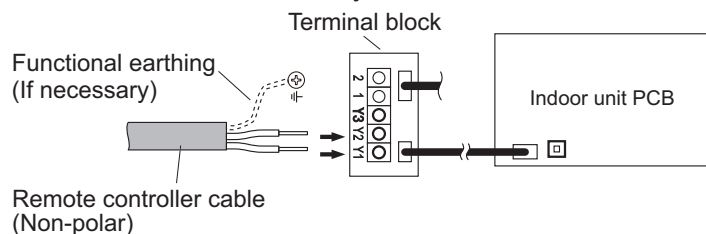

NOTES:

- Layout of terminal block and PCB varies depending on the type of indoor unit.
- Operation may fail if it is connected to the outdoor unit or the terminal block for power supply.

14. Function settings

To adjust the functions of this product according to the installation environment, various types of function settings are available.

NOTE: Incorrect settings can cause a product malfunction.

14-1. Compact cassette, slim duct, and floor/ceiling types indoor unit (setting by DIP switch and jumper wire)

By using some components on the PCB, you can change the function settings.

Related components on the PCB and the applicable settings:

Component		Setting content
DIP switch	1	Remote controller address setting
	2	
	3	
	4	
Jumper wire	JM1	Drainage function setting
	JM2	Auto louver grille setting
	JM3	Fan delay setting

■ Component location

Components on the indoor unit main PC board used for the function settings are located as shown in the following figure.

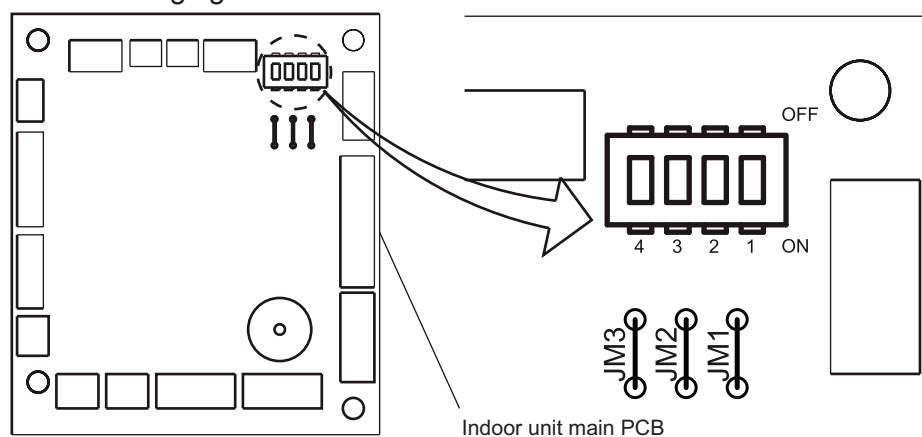

■ Dip switch setting

Remote controller address setting:

When operating a number of indoor units by using a wired remote controller, DIP switch setting for assigning unit number to each indoor unit is required.

DIP switches are normally set to make the unit number 00.

Remote controller address	DIP switch number				Factory setting
	1	2	3	4	
00	OFF	OFF	OFF	OFF	◆
01	ON	OFF	OFF	OFF	
02	OFF	ON	OFF	OFF	
03	ON	ON	OFF	OFF	
04	OFF	OFF	ON	OFF	
05	ON	OFF	ON	OFF	
06	OFF	ON	ON	OFF	
07	ON	ON	ON	OFF	
08	OFF	OFF	OFF	ON	
09	ON	OFF	OFF	ON	
10	OFF	ON	OFF	ON	
11	ON	ON	OFF	ON	
12	OFF	OFF	ON	ON	
13	ON	OFF	ON	ON	
14	OFF	ON	ON	ON	
15	ON	ON	ON	ON	

■ Jumper wire setting

• Drainage function setting (JM1)

JM1	Function	Factory setting
Connect	Enable	◆
Disconnect	Disable	

• Auto louver grille setting (JM2)

When auto louver grille kit (optional parts) is attached, set the auto louver grille setting "Enable".

JM2	Function	Factory setting
Connect	Disable	◆
Disconnect	Enable	

• Fan delay setting (JM3)

JM3	Function	Factory setting
Connect	Disable	◆
Disconnect	Enable	

14-2. Mini duct type indoor unit (setting by DIP switch)

By using some components on the PCB, you can change the function settings.

Related components on the PCB and the applicable settings:

Component		Setting content
DIP switch100	1	Remote controller address setting
	2	
	3	
	4	
DIP switch101	1	Drainage function setting
	2	Auto louver grille setting
	3	Fan delay setting

■ Component location

Components on the indoor unit main PCB used for the function settings are located as shown in the following figure.

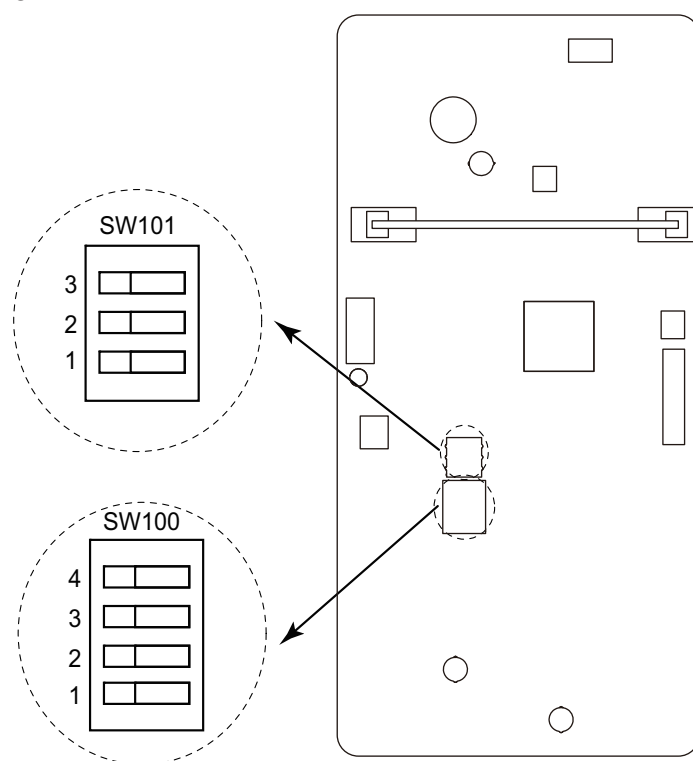

■ DIP switch setting

- **Remote controller address setting (SW100)**

When operating a number of indoor units by using a wired remote controller, DIP switch setting for assigning unit number to each indoor unit is required.

DIP switches are normally set to make the unit number 00.

Remote controller address	DIP switch number				Factory setting
	1	2	3	4	
00	OFF	OFF	OFF	OFF	◆
01	ON	OFF	OFF	OFF	
02	OFF	ON	OFF	OFF	
03	ON	ON	OFF	OFF	
04	OFF	OFF	ON	OFF	
05	ON	OFF	ON	OFF	
06	OFF	ON	ON	OFF	
07	ON	ON	ON	OFF	
08	OFF	OFF	OFF	ON	
09	ON	OFF	OFF	ON	
10	OFF	ON	OFF	ON	
11	ON	ON	OFF	ON	
12	OFF	OFF	ON	ON	
13	ON	OFF	ON	ON	
14	OFF	ON	ON	ON	
15	ON	ON	ON	ON	

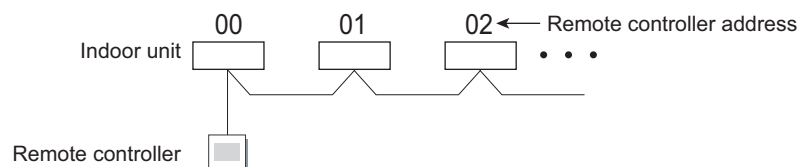

- **Switch 1: Drainage function setting (SW101)**

Switch 1	Drainage function	Factory setting
ON	Disabled	
OFF	Enabled	◆

- **Switch 2: Auto louver grille setting (SW101)**

When Auto louver grille kit (optional parts) is attached, set to "Enabled".

Switch 2	Auto louver grille setting	Factory setting
ON	Enabled	
OFF	Disabled	◆

- **Switch 3: Fan delay setting (SW101)**

When the indoor unit is stopped while operating in conjunction with auxiliary heater, the indoor unit fan operation will continue for 1 minute.

Switch 3	Fan delay	Factory setting
ON	Enabled	
OFF	Disabled	◆

14-3. Indoor unit (setting by wireless remote controller)

- The function settings of the control of the indoor unit can be changed by this procedure according to the installation conditions. Incorrect settings can cause the indoor unit malfunction.
- After the power is turned on, perform the "Function setting" according to the installation conditions using the remote controller.
- The settings may be selected between the following two: Function number or Setting number.
- Settings will not be changed if invalid numbers or setting numbers are selected.

■ Preparation

Before connecting the power supply of the indoor unit, reconfirm following items:

- Piping air tight test and vacuuming have been performed firmly.
- There is no wiring mistake. Then, connect the power supply of the indoor unit.

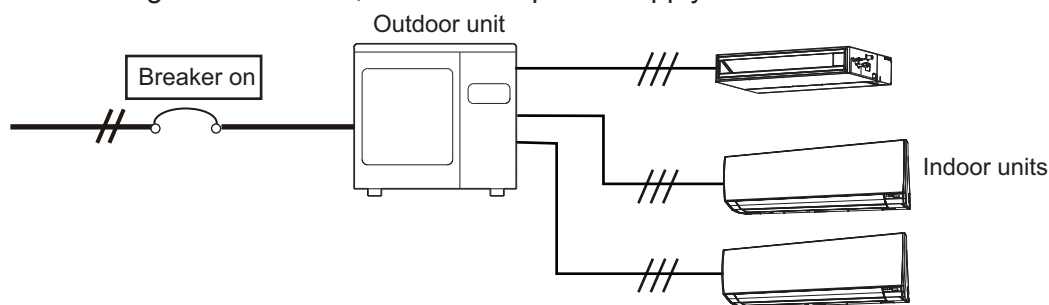

■ AR-RAH2E/AR-RAH1E

● Button name and function

During address setting mode, indoor unit reject the any operation command from remote controller.

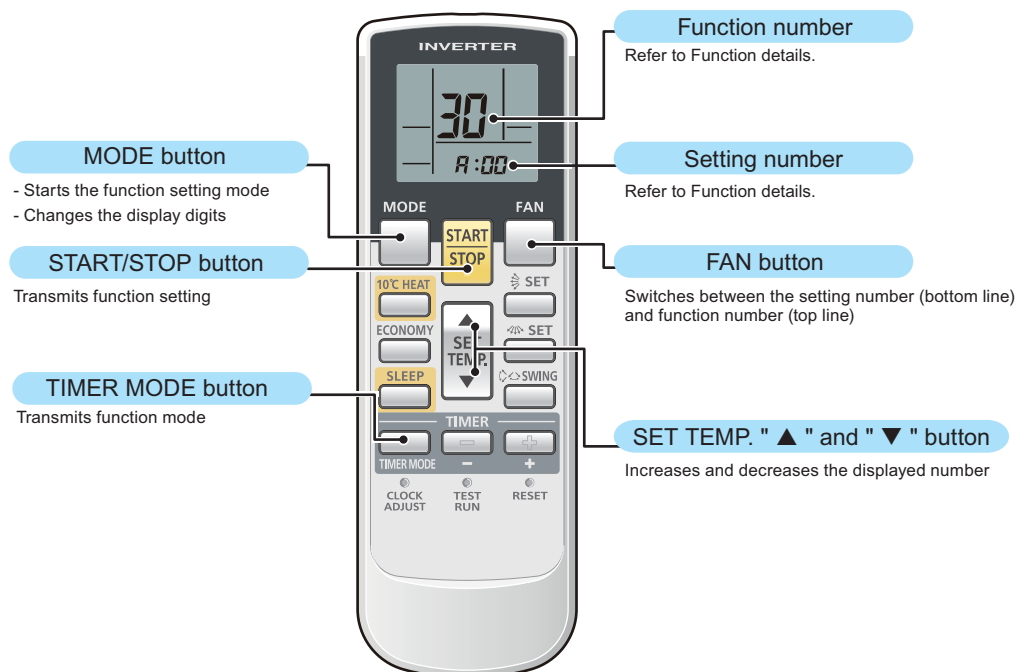

NOTE: Actual number of buttons might be different from the figures in following instructions.

● Function setting procedure

1. Connect the power supply of the outdoor unit.
2. To enter the function setting mode, while holding down the FAN and the SET TEMP. ▲ buttons, press the RESET button.

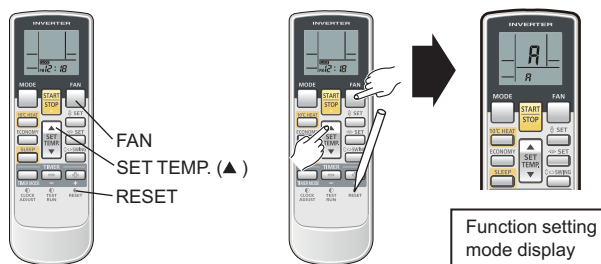

3. Press the SET TEMP. ▲ or ▼ buttons to select the custom code that matches the setting with the indoor unit. By selecting the appropriate custom code, the communication between the indoor unit and the wireless remote controller become possible.

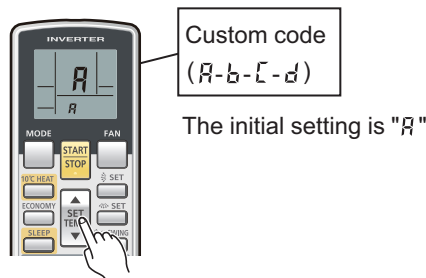

4. For confirming the custom code, press the TIMER MODE button to send the code to the indoor unit.

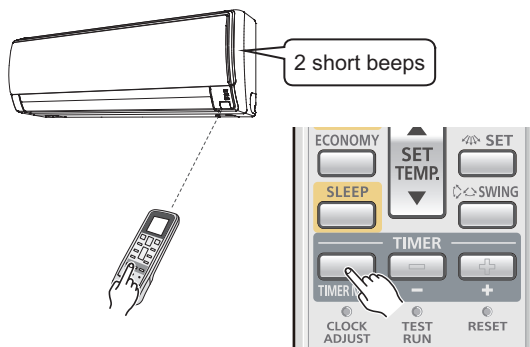

5. Press the MODE button to enter the function setting mode.

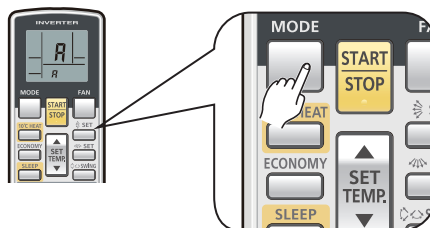

6. Select the function number by pressing the ▲ or the ▼ button. Each time the MODE button is pressed, it switches between the left digit and the right digit.

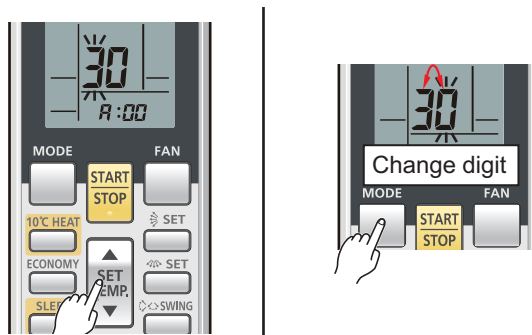

7. Proceed to number setting by pressing the FAN button.
To return to the function number selection, press the FAN button again.



8. Select the setting number by pressing the ▲ or the ▼ button.
Each time the MODE button is pressed, it switches between the left digit and the right digit.

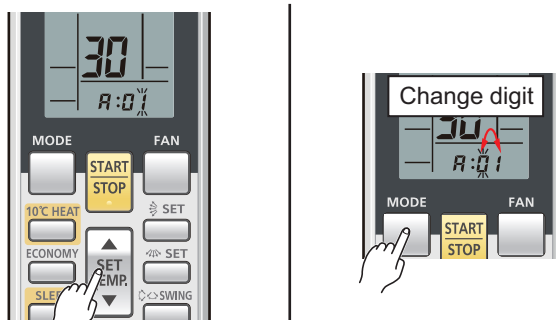

9. Send the function mode information by pressing the TIMER MODE button once.

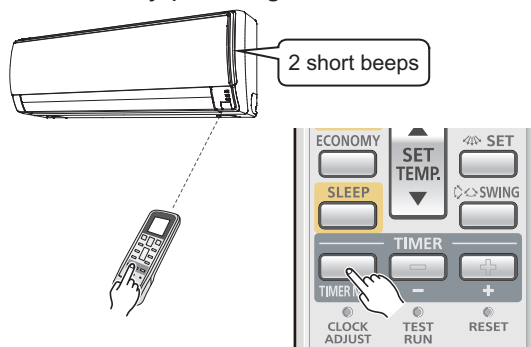

10. Send the function setting information by pressing the START/STOP button once.
2 short beeps will be emitted from the indoor unit when the signal is received correctly. If wrong code is set, no beep sound will be emitted.

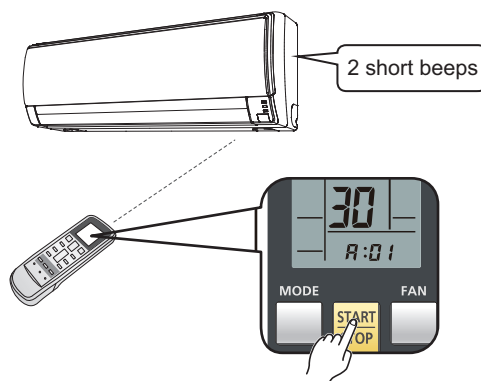

NOTE: Press START/STOP button within 30 seconds after pressing TIMER MODE button.

Function details: Refer to Chapter 14-6. ["Function details"](#) on page 241.

11. Exit the function setting mode by pressing the RESET button.

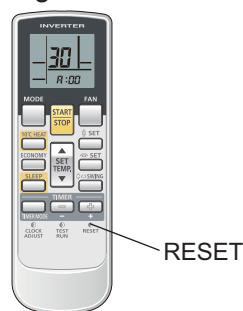

To set custom code **b**, **c**, or **d**, perform same procedures for each code.

● Setting up each indoor unit

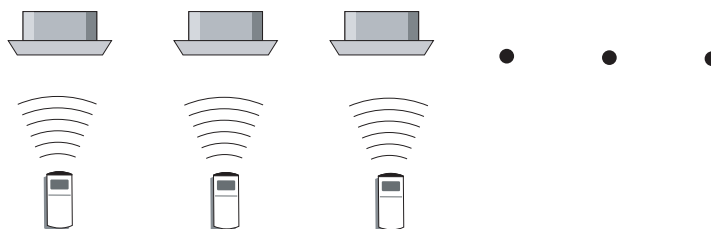

Repeat step from 1. to 11. to set up each indoor unit. If the custom code is other than "A", steps from 1. to 4. and 11. need to be performed.

● Resetting the power after setting up all indoor units

NOTES:

- If the reset is not performed, function cannot be read correctly.
- After all the functions have been set, the circuit breaker needs to be switched off for at least 2 minutes.
 - After the 2 minutes has passed, power can be restored.
 - The set function is stored in the PCB and will remain in memory even when the power of indoor unit is turned off. However setting function is effective after disconnecting the power supply and then reconnecting it.
- Record the latest configuration of the indoor unit function setting on a label, and put the label on the unit so it can be used for after-sales service operations.

Once the RESET button is pressed on the remote controller, the operation mode will be set to the AUTO MODE.

Adjust the operation mode to either cooling or heating before starting the operation of the air conditioner.

NOTE: If custom code other than "A" is set, the remote control must be set accordingly to the indoor unit setting.

● Remote controller custom code setting

Custom code setting of wireless remote controller needs to be same as the setting of the indoor unit. When you change the custom code setting of the wireless remote controller, do as follows:

1. Press the START/STOP button until only the clock is displayed on the remote controller display.

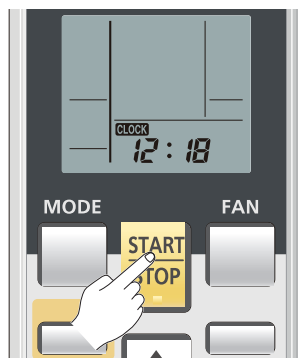

2. Press the MODE button for at least 5 seconds to display the current custom code (initially set to A).

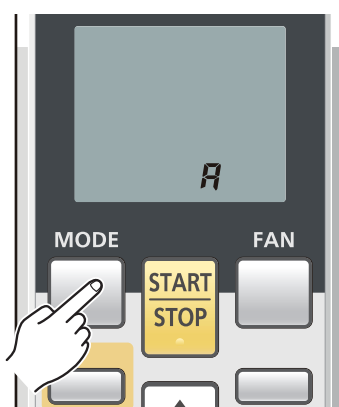

3. Press the SET TEMP. ▲ or the ▼ button to change the custom code between A → b → c → d.

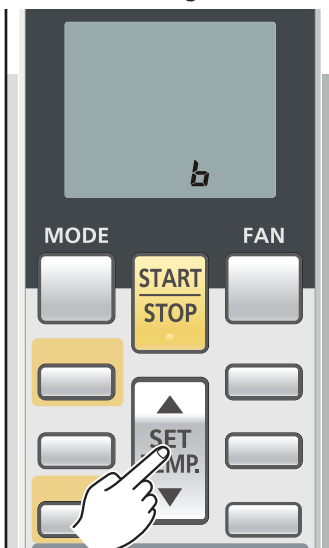

4. Press the MODE button again to return to the clock display. The custom code will be changed.

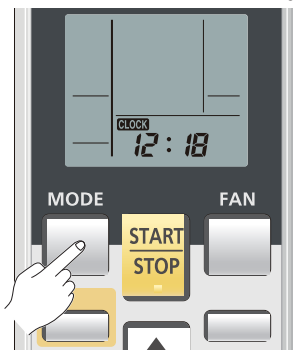

- If no buttons are pressed within 30 seconds after the custom code is displayed, the system returns to the original clock display. In this case, start again from step 1.
- The air conditioner custom code is set to A prior to shipment.
- The remote controller resets to custom code A when the batteries in the remote controller are replaced. If you use a custom code other than custom code A, reset the custom code after replacing the batteries. If you do not know the air conditioner custom code setting, try each of the custom codes (A → B → C → D) until you find the code which operates the air conditioner.

AR-REA2E

● Button name and function

During address setting mode, indoor unit reject the any operation command from remote controller.

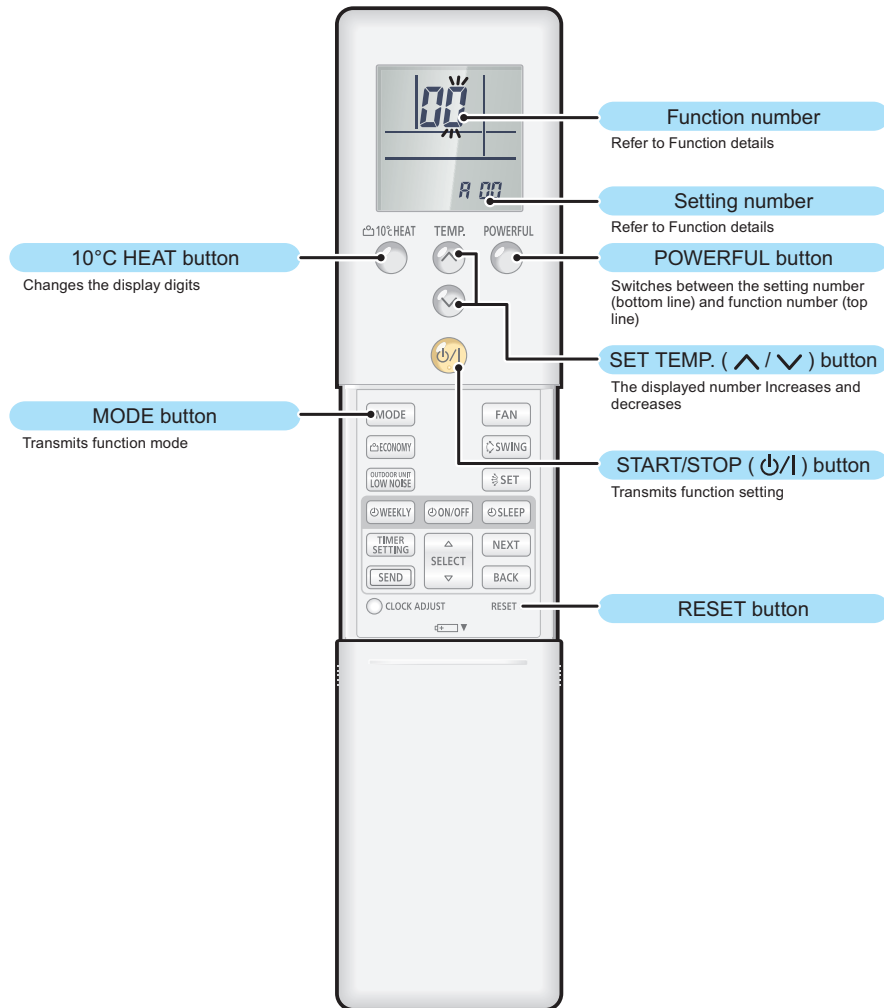

● Function setting procedure

1. Connect the power supply of the outdoor unit.
2. To enter the function setting mode, while holding down the POWERFUL and SET TEMP. ^ buttons, press the RESET button.

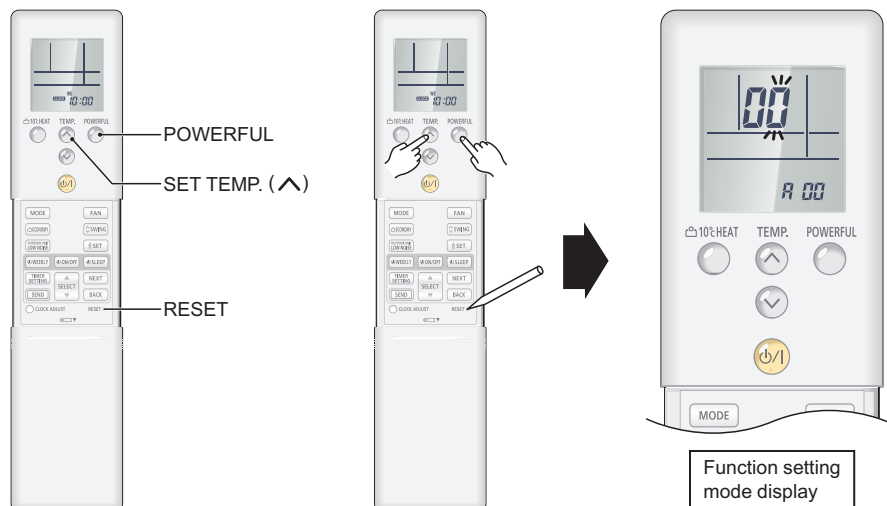

3. Select the function number by pressing the \wedge or the \vee buttons. Each time the 10°C HEAT button is pressed, it switches between the right digit and the left digit.



4. Proceed to the setting number by pressing the POWERFUL button. (To return to the function number selection, press the POWERFUL button again.)



5. Select the function number by pressing the \wedge or the \vee button. Each time the 10°C HEAT button is pressed, it switches between the right digit and the left digit.

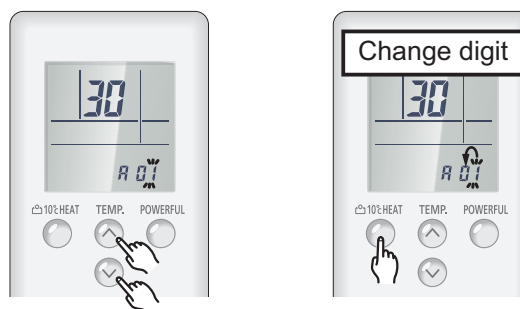

6. Press the MODE button once to transmit the function mode information.

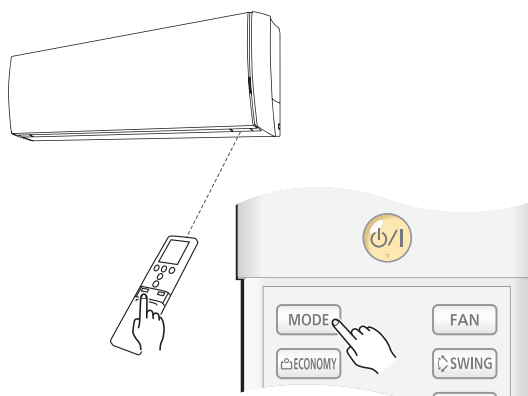

7. Press the $\phi/|$ button once to transmit the function setting information. 2 short beeps will be emitted from the indoor unit when the signal is received correctly. If wrong code is set, no beep sound will be emitted.

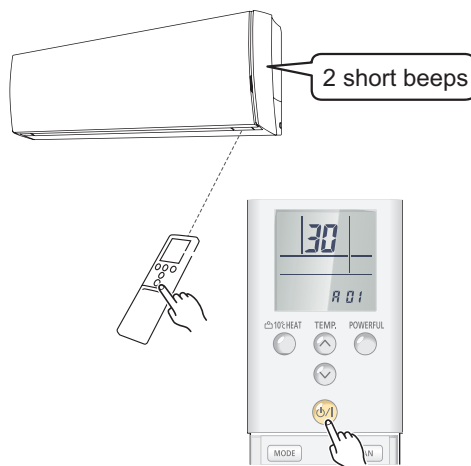

NOTE: Press $\phi/|$ button within 30 seconds after pressing MODE button.

For the function details, refer to Chapter 14-6. "[Function details](#)" on page 241.

8. Exit the function setting mode by pressing the RESET button.



● Setting up each indoor unit

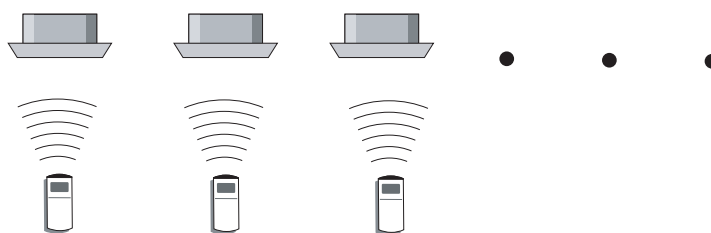

Repeat step from 1. to 8. to set up each indoor unit. If the custom code is other than "F", steps from 1. to 2. and 8. need to be performed.

● Resetting the power after setting up all indoor units

NOTES:

- If the reset is not performed, function cannot be read correctly.
- After all the functions have been set, the circuit breaker needs to be switched off for at least 2 minutes.
 - After the 2 minutes has passed, power can be restored.
 - The set function is stored in the PCB and will remain in memory even when the power of indoor unit is turned off.
However setting function is effective after disconnecting the power supply and then reconnecting it.
- Record the latest configuration of the indoor unit function setting on a label, and put the label on the unit so it can be used for after-sales service operations.

Once the RESET button is pressed on the remote controller, the operation mode will be set to the AUTO MODE.

Adjust the operation mode to either cooling or heating before starting the operation of the air conditioner.

NOTE: If custom code other than "F" is set, the remote control must be set accordingly to the indoor unit setting.

● Remote controller custom code setting

Custom code setting of wireless remote controller needs to be same as the setting of the indoor unit. When you change the custom code setting of the wireless remote controller, do as follows:

1. Press the START/STOP button until only the clock is displayed on the display.



2. Press the MODE button for at least 5 seconds to display the current custom code (initially set to A).



3. Press the SET TEMP. “ ^ ” or the “ v ” button to change the custom code between A → b → c → d.



4. Press the MODE button again to return to the clock display. The custom code will be changed.



- If no buttons are pressed within 30 seconds after the custom code is displayed, the system returns to the original clock display. In this case, start again from step 1.
- The air conditioner custom code is set to A prior to shipment.
- If you do not know the air conditioner custom code setting, try each of the custom codes (A → b → c → d) until you find the code which operates the air conditioner.

■ AR-REB1E

● Button name and function

During address setting mode, indoor unit reject the any operation command from remote controller.

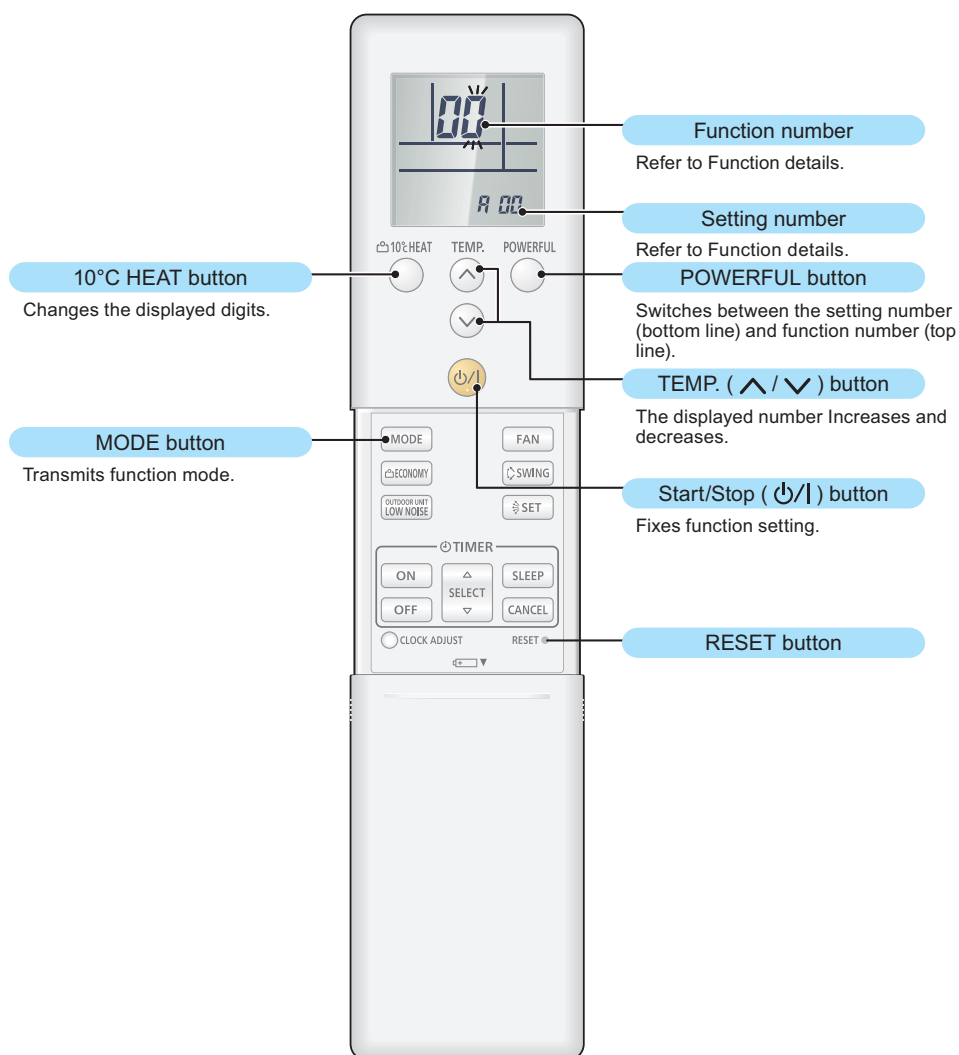

● Function setting procedure

1. Connect the power supply of the outdoor unit.
2. To enter the function setting mode, while holding down the POWERFUL and SET TEMP. ^ buttons, press the RESET button.

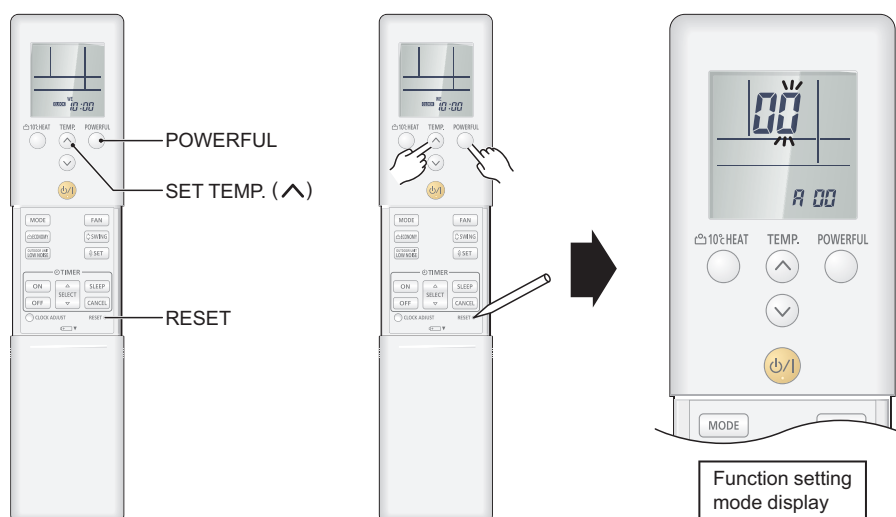

3. Select the function number by pressing the \wedge or the \vee buttons. Each time the 10°C HEAT button is pressed, it switches between the right digit and the left digit.



4. Proceed to the setting number by pressing the POWERFUL button. (To return to the function number selection, press the POWERFUL button again.)



5. Select the function number by pressing the \wedge or the \vee button. Each time the 10°C HEAT button is pressed, it switches between the right digit and the left digit.

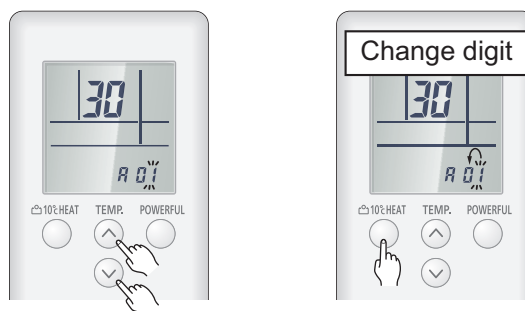

6. Press the MODE button once to transmit the function mode information.

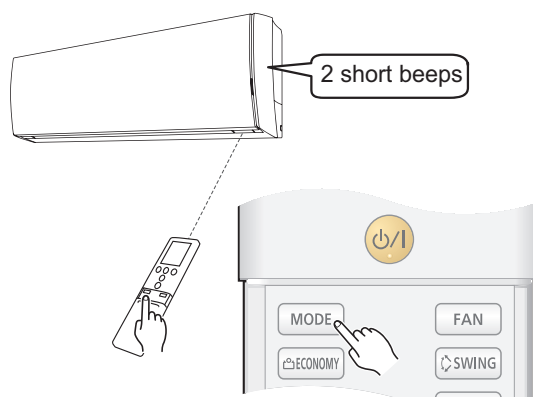

7. Press the ϕ/I button once to transmit the function setting information. 2 short beeps will be emitted from the indoor unit when the signal is received correctly. If wrong code is set, no beep sound will be emitted.

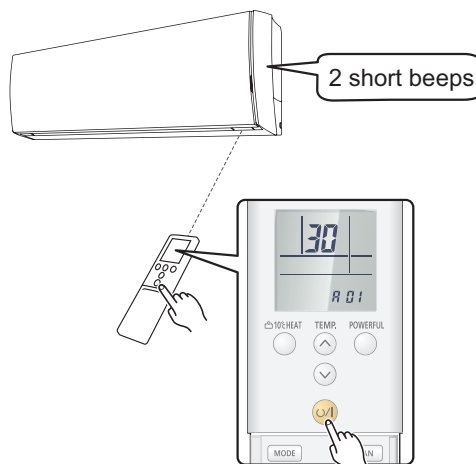

NOTE: Press ϕ/I button within 30 seconds after pressing MODE button.

For the function details, refer to Chapter 14-6. "[Function details](#)" on page 241.

8. Exit the function setting mode by pressing the RESET button.

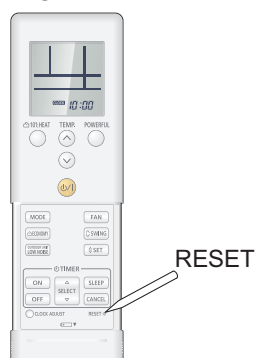

● Setting up each indoor unit

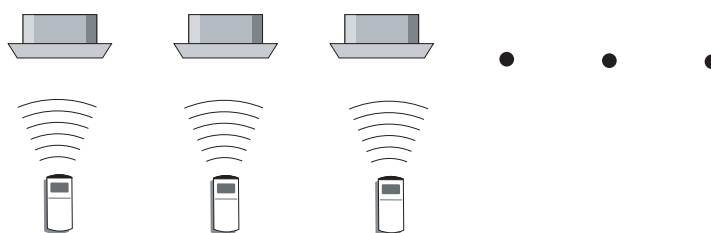

Repeat step from 1. to 8. to set up each indoor unit. If the custom code is other than "R", steps from 1. to 2. and 8. need to be performed.

● Resetting the power after setting up all indoor units

NOTES:

- If the reset is not performed, function cannot be read correctly.
- After all the functions have been set, the circuit breaker needs to be switched off for at least 2 minutes.
 - After the 2 minutes has passed, power can be restored.
 - The set function is stored in the PCB and will remain in memory even when the power of indoor unit is turned off.
However setting function is effective after disconnecting the power supply and then reconnecting it.
- Record the latest configuration of the indoor unit function setting on a label, and put the label on the unit so it can be used for after-sales service operations.

Once the RESET button is pressed on the remote controller, the operation mode will be set to the AUTO MODE.

Adjust the operation mode to either cooling or heating before starting the operation of the air conditioner.

NOTE: If custom code other than "F" is set, the remote control must be set accordingly to the indoor unit setting.

● Remote controller custom code setting

Custom code setting of wireless remote controller needs to be same as the setting of the indoor unit. When you change the custom code setting of the wireless remote controller, do as follows:

1. Press the START/STOP button until only the clock is displayed on the display.



2. Press the MODE button for at least 5 seconds to display the current custom code (initially set to A).



3. Press the SET TEMP. “ ^ ” or the “ √ ” button to change the custom code between A → b → c → d.



4. Press the MODE button again to return to the clock display. The custom code will be changed.



- If no buttons are pressed within 30 seconds after the custom code is displayed, the system returns to the original clock display. In this case, start again from step 1.
- The air conditioner custom code is set to A prior to shipment.
- If you do not know the air conditioner custom code setting, try each of the custom codes (A → b → c → d) until you find the code which operates the air conditioner.

■ AR-REJ1E (included in UTY-LBTYM)

● Button name and function

During address setting mode, indoor unit reject the any operation command from remote controller.

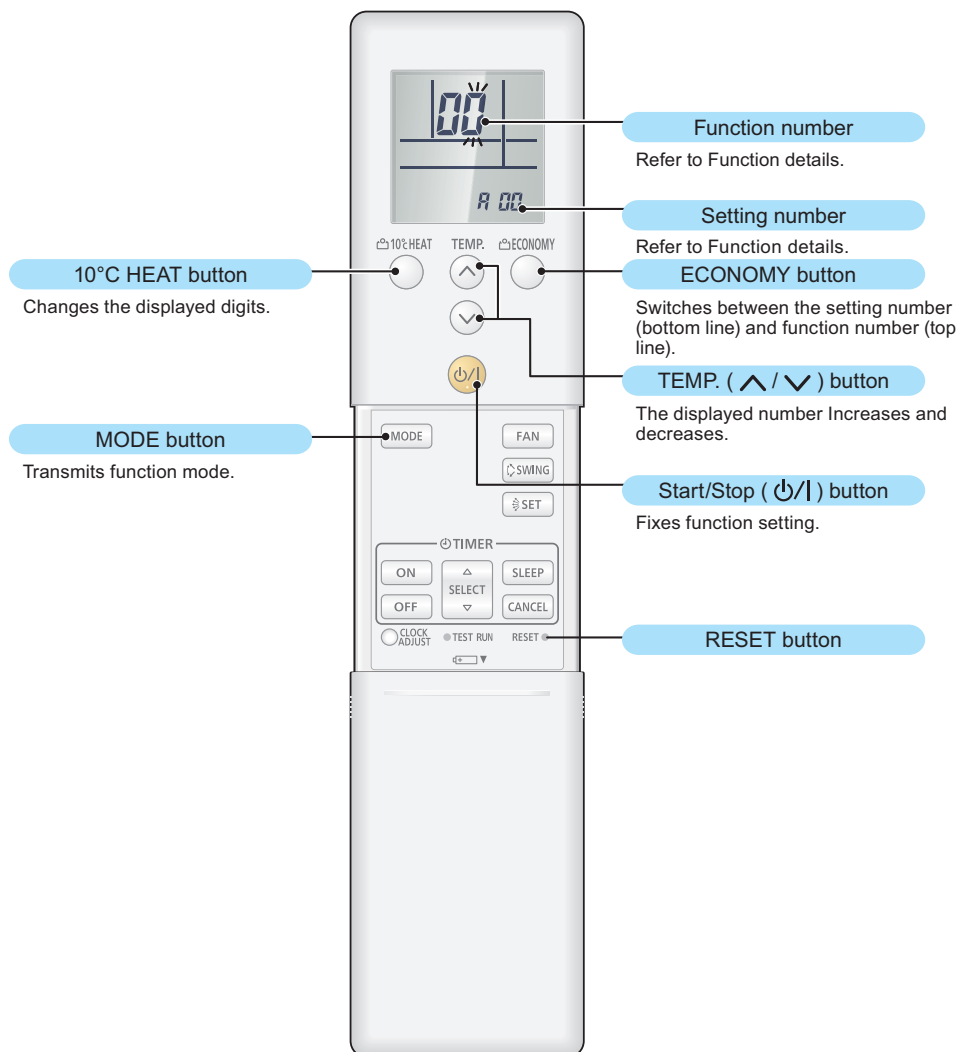

● Function setting procedure

1. Connect the power supply of the outdoor unit.
2. To enter the function setting mode, while holding down the ECONOMY and SET TEMP. ^ buttons, press the RESET button.

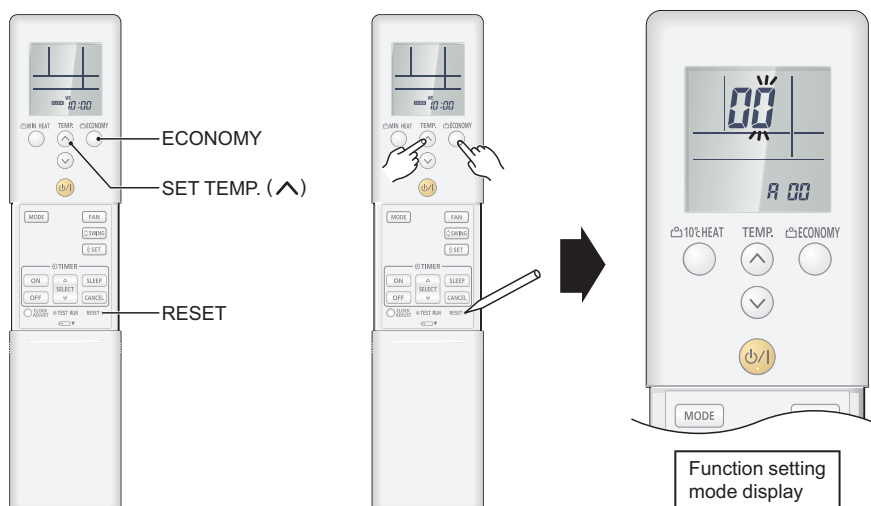

3. Select the function number by pressing the \wedge or the \vee buttons. Each time the 10°C HEAT button is pressed, it switches between the right digit and the left digit.



4. Proceed to the setting number by pressing the ECONOMY button. (To return to the function number selection, press the ECONOMY button again.)



5. Select the function number by pressing the \wedge or the \vee button. Each time the 10°C HEAT button is pressed, it switches between the right digit and the left digit.

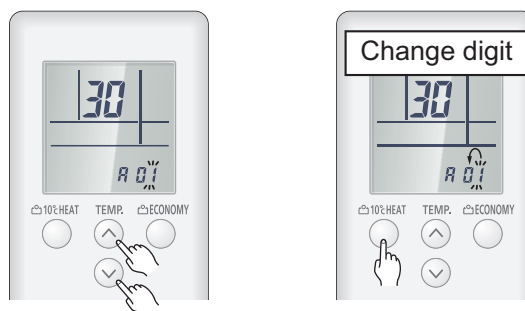

6. Press the MODE button once to transmit the function mode information.

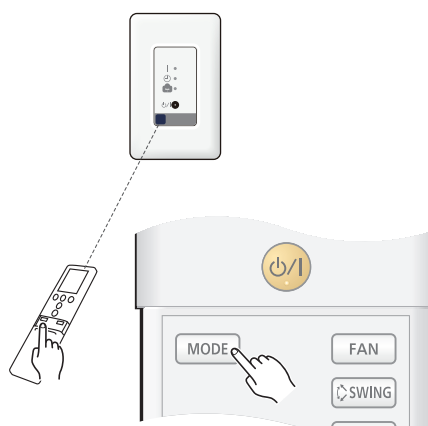

7. Press the ϕ/I button once to transmit the function setting information. 1 short beep will be emitted from the IR receiver when the signal is received correctly. If wrong code is set, no beep sound will be emitted.

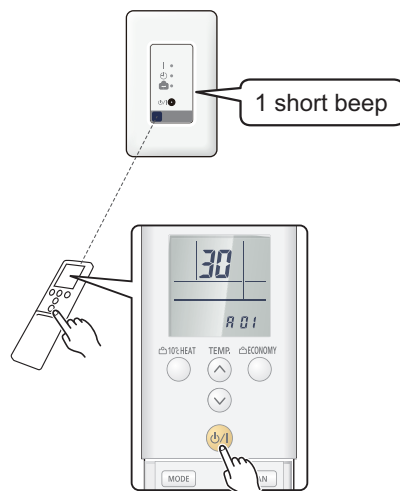

NOTE: Press ϕ/I button within 30 seconds after pressing MODE button.

For the function details, refer to Chapter 14-6. "[Function details](#)" on page 241.

8. Exit the function setting mode by pressing the RESET button.

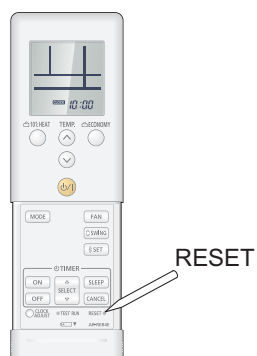

● Setting up each indoor unit

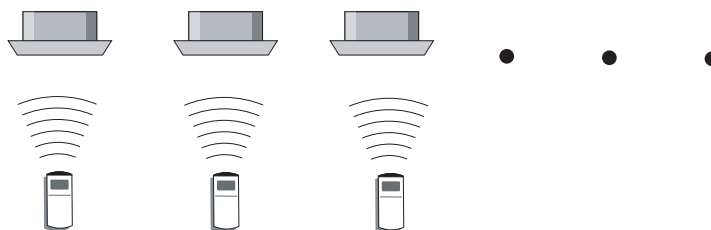

Repeat step from 1. to 8. to set up each indoor unit. If the custom code is other than "F", steps from 1. to 2. and 8. need to be performed.

● Resetting the power after setting up all indoor units

NOTES:

- If the reset is not performed, function cannot be read correctly.
- After all the functions have been set, the circuit breaker needs to be switched off for at least 2 minutes.
 - After the 2 minutes has passed, power can be restored.
 - The set function is stored in the PCB and will remain in memory even when the power of indoor unit is turned off. However setting function is effective after disconnecting the power supply and then reconnecting it.
- Record the latest configuration of the indoor unit function setting on a label, and put the label on the unit so it can be used for after-sales service operations.

Once the RESET button is pressed on the remote controller, the operation mode will be set to the AUTO MODE.

Adjust the operation mode to either cooling or heating before starting the operation of the air conditioner.

NOTE: If custom code other than "F" is set, the remote control must be set accordingly to the indoor unit setting.

● Remote controller custom code setting

Custom code setting of wireless remote controller needs to be same as the setting of the indoor unit. When you change the custom code setting of the wireless remote controller, do as follows:

1. Press the START/STOP button until only the clock is displayed on the display.

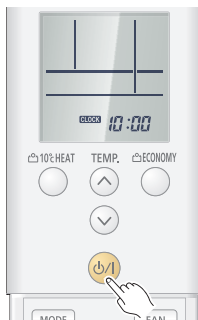

2. Press the MODE button for at least 5 seconds to display the current custom code (initially set to A).
3. Press the SET TEMP. “ ^ ” or the “ v ” button to change the custom code between A → b → c → d.

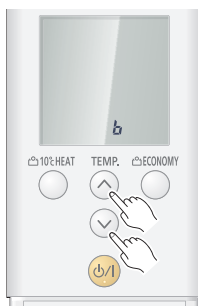

4. Press the MODE button again to return to the clock display. The custom code will be changed.



- If no buttons are pressed within 30 seconds after the custom code is displayed, the system returns to the original clock display. In this case, start again from step 1.
- The air conditioner custom code is set to A prior to shipment.
- If you do not know the air conditioner custom code setting, try each of the custom codes (A → b → c → d) until you find the code which operates the air conditioner.

14-4. Indoor unit (setting by wired remote controller)

- The function settings of the control of the indoor unit can be changed by this procedure according to the installation conditions. Incorrect settings can cause the indoor unit malfunction.
- After the power is turned on, perform the “Function setting” according to the installation conditions using the remote controller.
- The settings may be selected between the following two: Function number or Setting number.
- Settings will not be changed if invalid numbers or setting numbers are selected.
- This function cannot be used on the secondary units.

■ Preparation

Before connecting the power supply of the indoor unit, reconfirm following items:

- Piping air tight test and vacuuming have been performed firmly.
- There is no wiring mistake. Then, connect the power supply of the indoor unit.

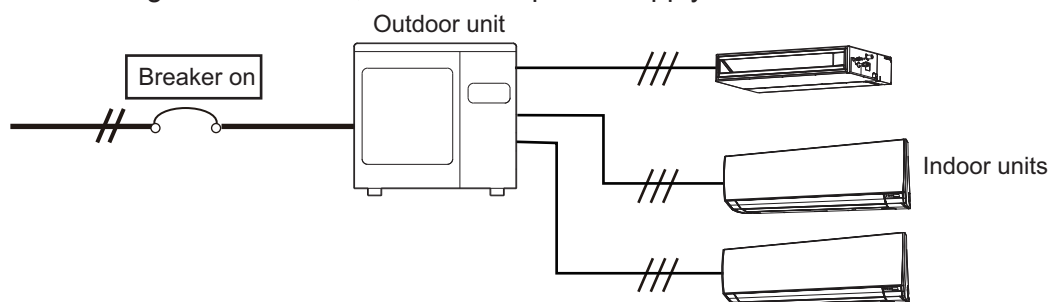

■ UTY-RNNYM

● Button name and function

During address setting mode, indoor unit reject the any operation command from remote controller.

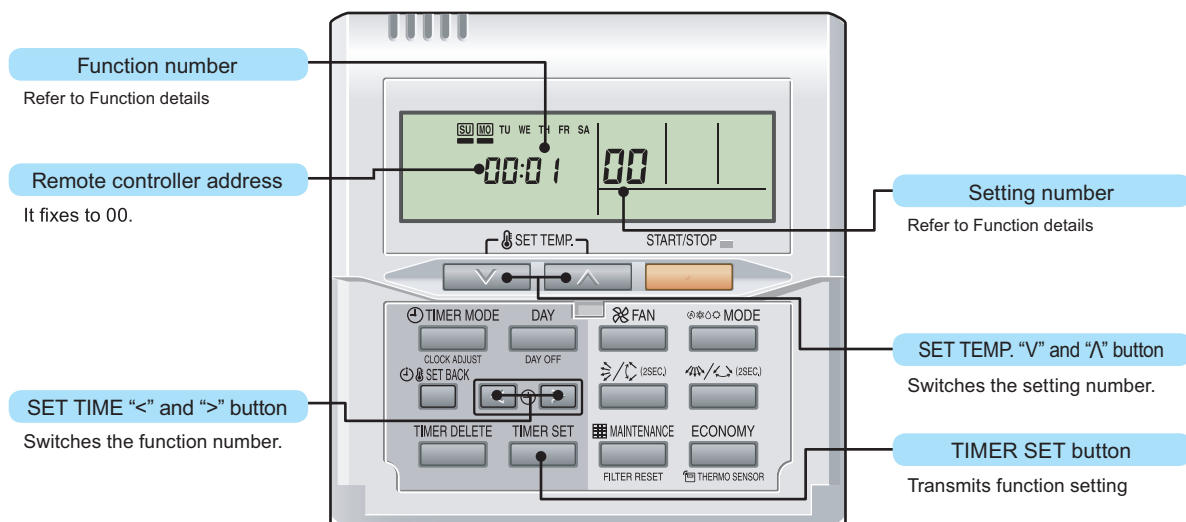

● Function setting procedure

1. Connect the power supply of the outdoor unit.
2. Switch to the function setting mode.

To enter the function setting mode, hold down the 3 buttons of SET TEMP. ∇ , SET TEMP. \blacktriangle , and FAN at the same time for 5 seconds or longer.

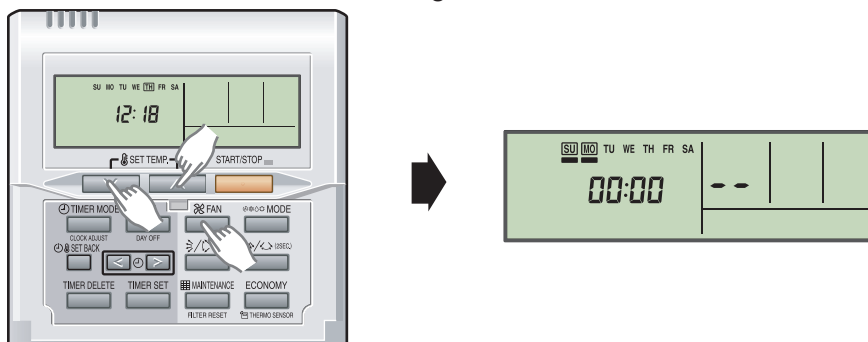

3. Select the function number by pressing the SET TIME < or the SET TIME > button.

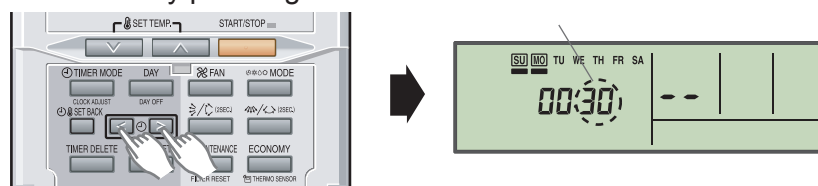

4. Select the setting number by pressing the SET TEMP. \blacktriangle or the SET TEMP. ∇ button. The display flashes during setting number selection.

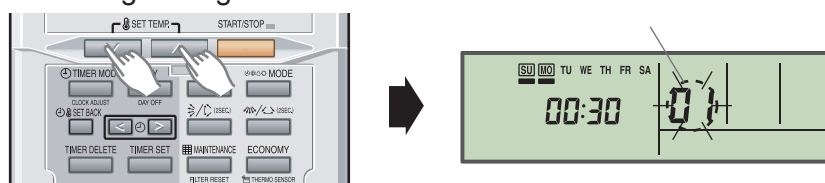

5. Confirm the setting by pressing the TIMER SET button.
The data will be transferred to the indoor unit.

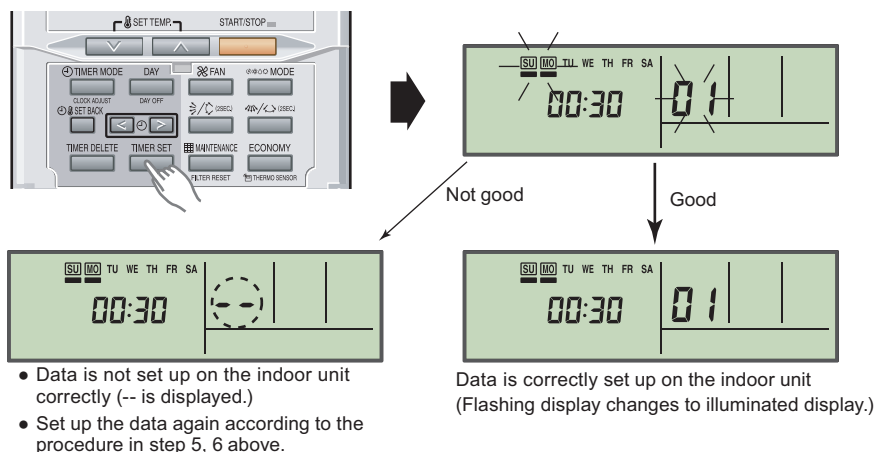

Function details: Refer to Chapter 14-6. "[Function details](#)" on page 241.

6. Exit the function setting mode by holding 3 buttons of SET TEMP. ∇ , SET TEMP. \wedge and FAN at the same time.

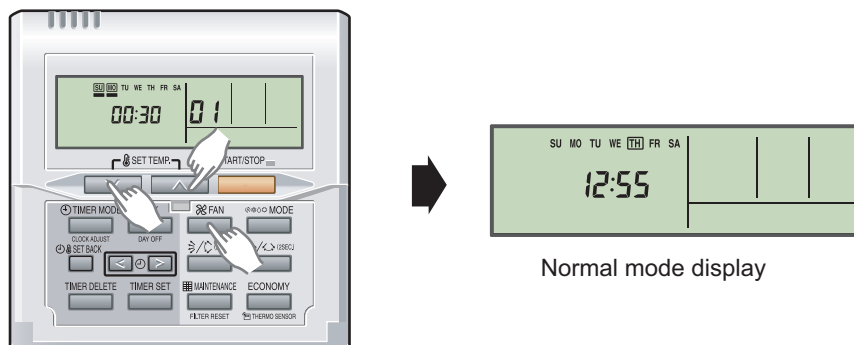

If no button is pressed within 60 seconds after buttons mentioned above are pressed, it will automatically exit the function setting mode.

If you exit the function setting mode unintentionally during setting, enter the mode again according to the procedure in step 2.

● Setting up each indoor unit

Repeat the procedures from step 1 to 6, and set up the indoor units requiring function setting.

● Resetting the power after setting up function of all indoor units

NOTES:

- If the reset is not performed, function cannot be read correctly.
- After all the functions have been set, the circuit breaker needs to be switched off for at least 2 minutes.
 - After the 2 minutes has passed, power can be restored.
 - The set function is stored in the PCB and will remain in memory even when the power of indoor unit is turned off.
However setting function is effective after disconnecting the power supply and then reconnecting it.
- Record the latest configuration of the indoor unit function setting on a label, and put the label on the unit so it can be used for after-sales service operations.

■ UTY-RVNYM

● Function setting procedure

1. Connect the power supply of the outdoor unit.
2. Switch to the function setting mode.

When [Menu button] is pressed twice while “Monitor” screen is displayed, it switches to the “Submenu” screen. If [Menu button] is pressed while the “Submenu” screen is displayed, the display returns to the “Monitor” screen.

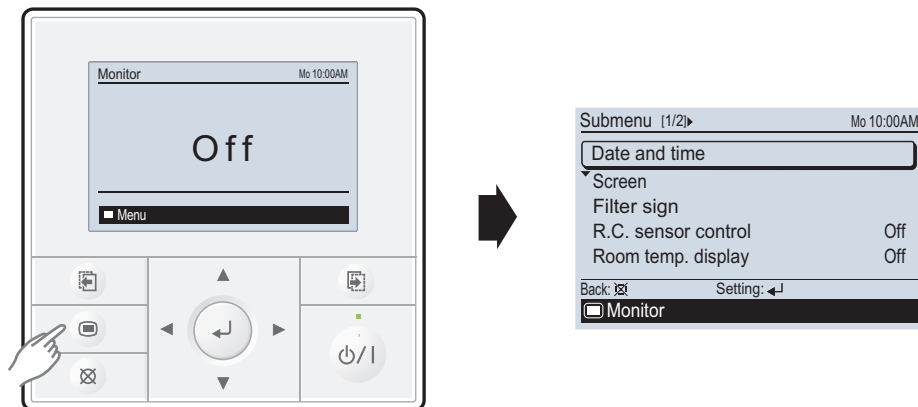

Press the [Screen switch button (Left)] and [Screen switch button (Right)] simultaneously for 5 seconds to switch to “Service” screen.

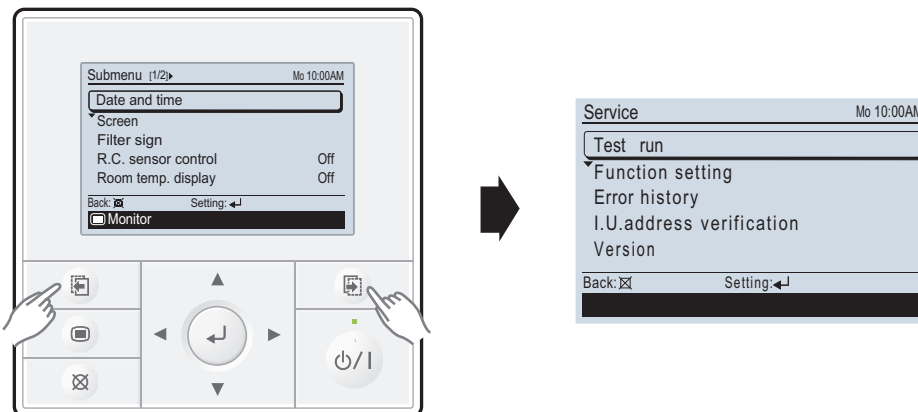

Select [Function setting] with pressing the [Cursor button (Up/Down)], and press the [Enter button].

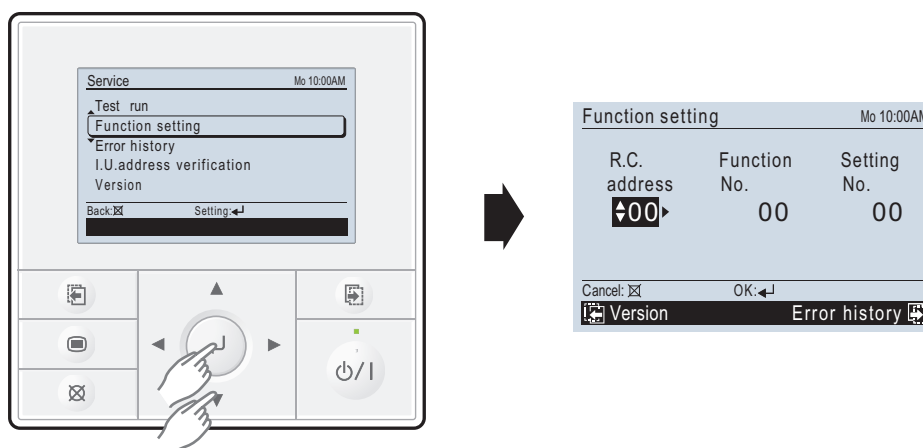

3. Select the [Function No.] with pressing the [Cursor button (Left/Right)], and select the Function No. to be set with pressing the [Cursor button (Up/Down)].

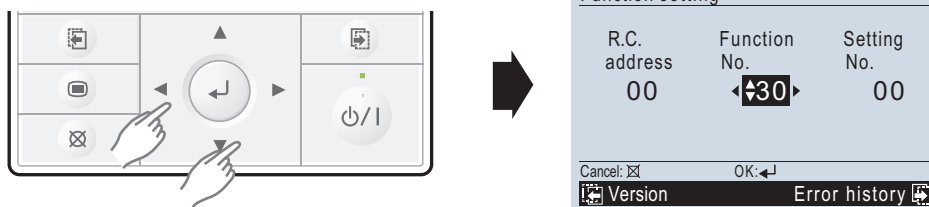

4. Select the [Setting No.] with pressing the [Cursor button (Left/Right)], and select the Setting No. to be set with pressing the [Cursor button (Up/Down)].

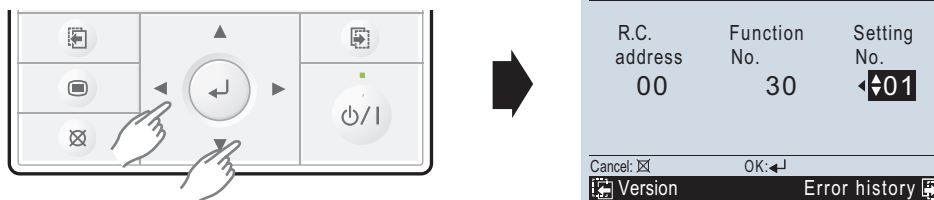

5. Pressing the [Enter button], confirm the setting. The data will be transferred to the indoor unit.

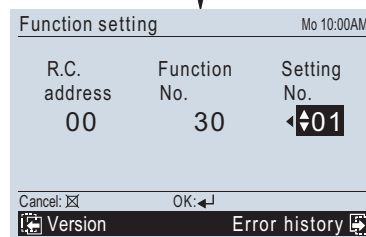
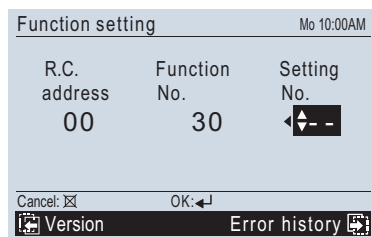
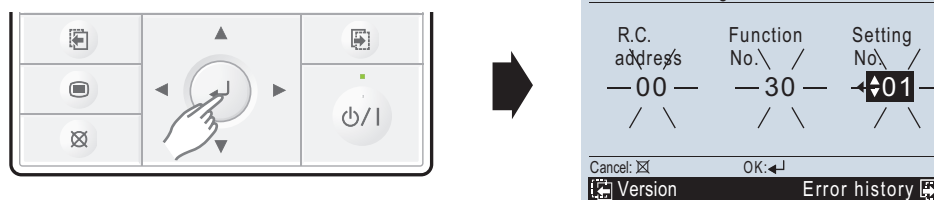

Function details: Refer to Chapter 14-6. "Function details" on page 241.

6. When [Cancel button] is pressed twice while “Function setting” screen is displayed, it switches to the “Submenu” screen.

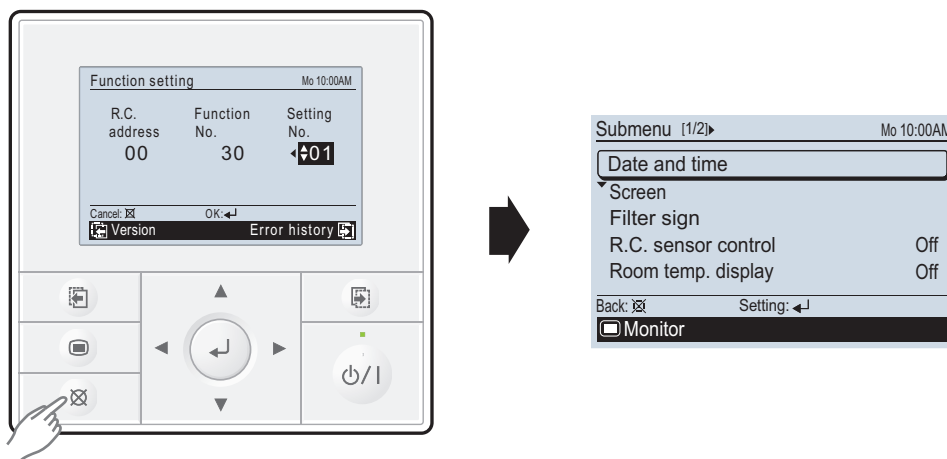

If no button is pressed within 60 seconds after buttons mentioned above are pressed, it will automatically exit the function setting mode.

If you exit the function setting mode unintentionally during setting, enter the mode again according to the procedure in step 2.

● Setting up each indoor unit

Repeat the procedures from step 1 to 6, and set up the indoor units requiring function setting.

● Resetting the power after setting up function of all indoor units

NOTES:

- If the reset is not performed, function cannot be read correctly.
- After all the functions have been set, the circuit breaker needs to be switched off for at least 2 minutes.
 - After the 2 minutes has passed, power can be restored.
 - The set function is stored in the PCB and will remain in memory even when the power of indoor unit is turned off. However setting function is effective after disconnecting the power supply and then reconnecting it.
- Record the latest configuration of the indoor unit function setting on a label, and put the label on the unit so it can be used for after-sales service operations.

■ UTY-RLRY

● Setting procedure by using wired remote controller

The function number and the associated setting value are displayed on the LCD of the remote controller. Follow the instructions written in the local setup procedure supplied with the remote controller, and select appropriate setting according to the installation environment.

Before connecting the power supply of the indoor unit, reconfirm following items:

- Piping air tight test and vacuuming have been performed firmly.
 - There is no wiring mistake.
1. Connect the power supply.
 2. To activate the address setting mode, hold down the three buttons of “MENU”, “<”, and “ENTER” at the same time for 2 seconds or longer. Menu 2 setting screen is displayed.

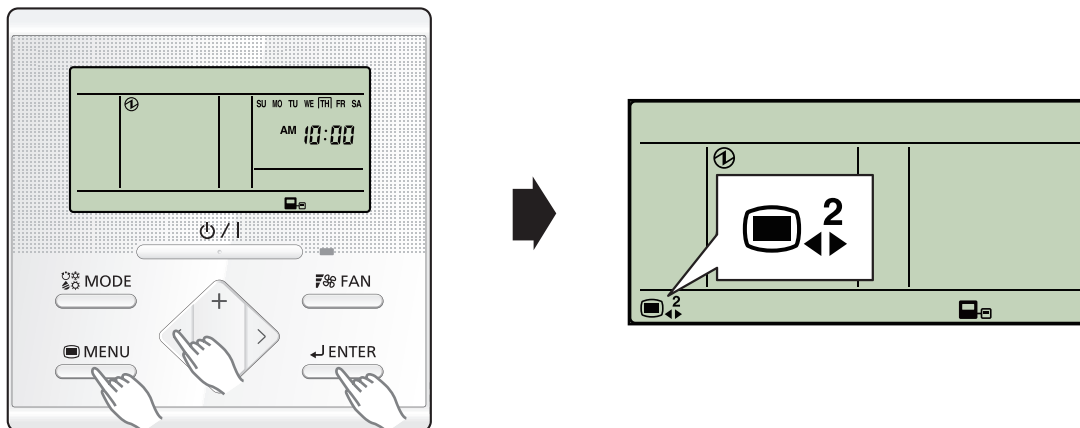

3. Select the “13” in Menu 2 settings. Then press the “ENTER” button.

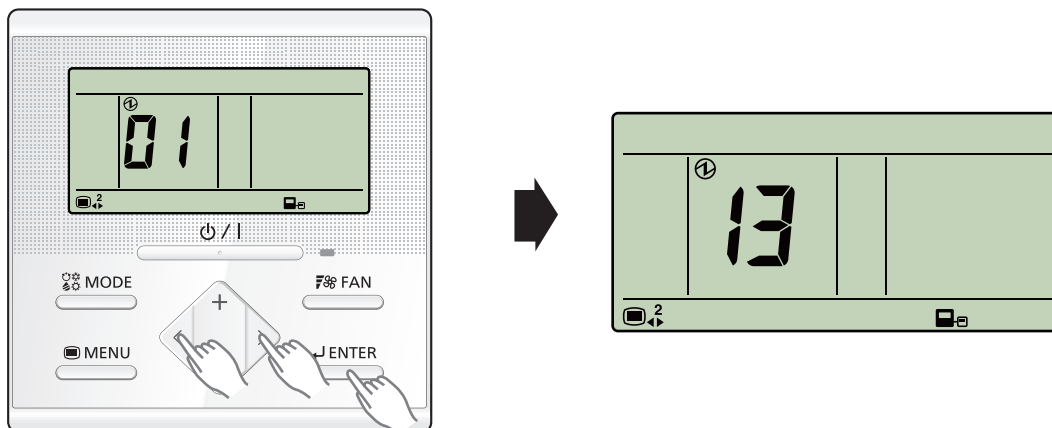

4. Pressing the “+” or “-” button, select a remote controller address (select the indoor unit you want to operate). Then press the “ENTER” button.

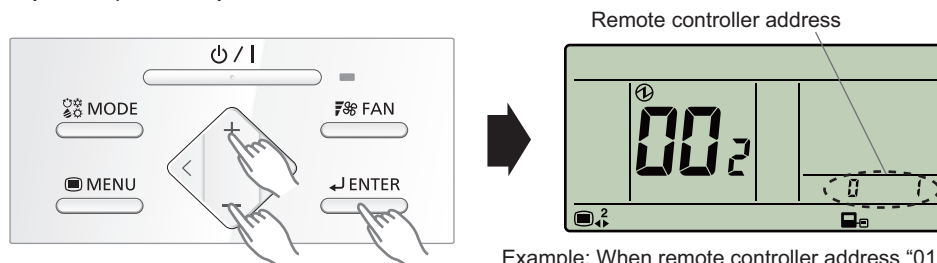

Example: When remote controller address “01” is selected.

5. Pressing the "+" or "-" button, to select the function number. Then press the "ENTER" button.

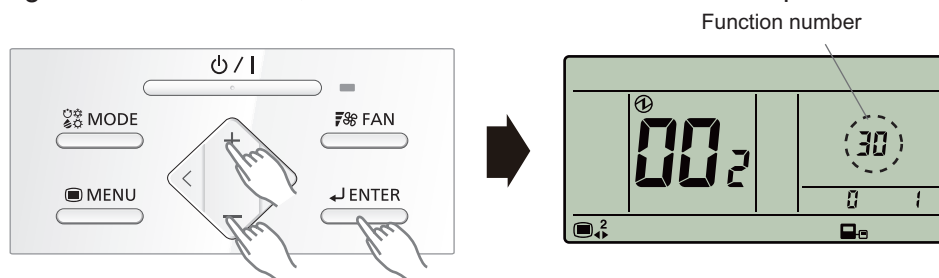

6. Pressing the "+" or "-" button, to select the setting number. Then press the "ENTER" button.

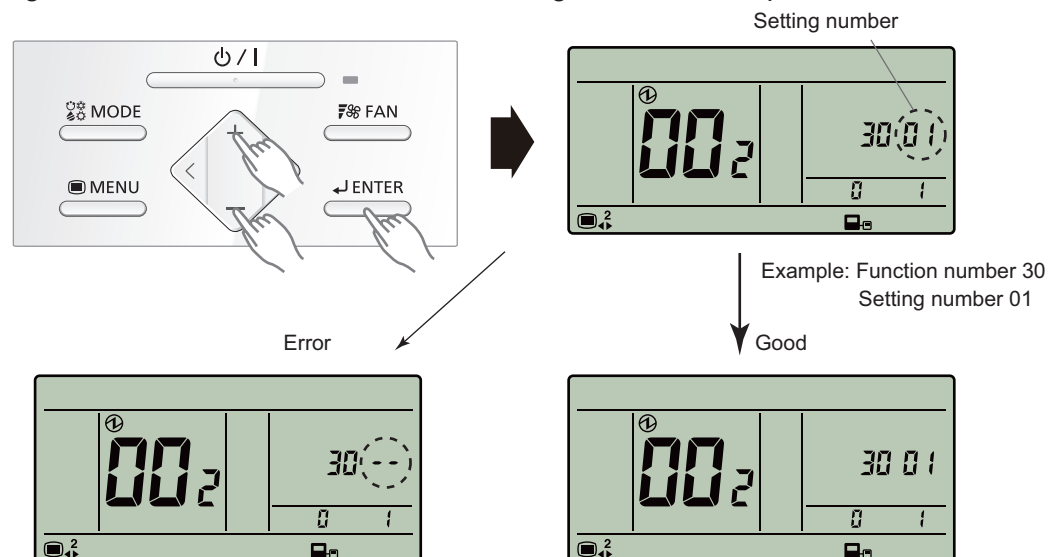

• When the data was not set up on the indoor unit (" --" is displayed.)

• Set up the data again.

• When the data was normally set up on the indoor unit.

Pressing the "ENTER" button to return to the address selection screen.

If setting has been completed, pressing the "MENU" button to return to the Menu 2 item selection screen.

● Setting up each indoor unit

Repeat the procedure from step 1 to 6, and set up the indoor units requiring function setting.

● Resetting the power after setting up function of all indoor units

NOTES:

- If the reset is not performed, function cannot be read correctly.
- After all the functions have been set, the circuit breaker needs to be switched off for at least 2 minutes.
 - After the 2 minutes has passed, power can be restored.
 - The set function is stored in the PCB and will remain in memory even when the power of indoor unit is turned off. However setting function is effective after disconnecting the power supply and then reconnecting it.
- Record the latest configuration of the indoor unit function setting on a label, and put the label on the unit so it can be used for after-sales service operations.

■ UTY-RNRYZ*

● Setting procedure by using wired remote controller

The function number and the associated setting value are displayed on the LCD of the remote controller. Follow the instructions written in the local setup procedure supplied with the remote controller, and select appropriate setting according to the installation environment.

Before connecting the power supply of the indoor unit, reconfirm following items:

- Piping air tight test and vacuuming have been performed firmly.
 - There is no wiring mistake.
1. Connect the power supply.
 2. When the “Function Setting” on the “Maintenance” screen is touched, the “Installer Password Verification” screen is displayed. After enter the installer password, and touch the “OK”, “Function Setting” screen is displayed.

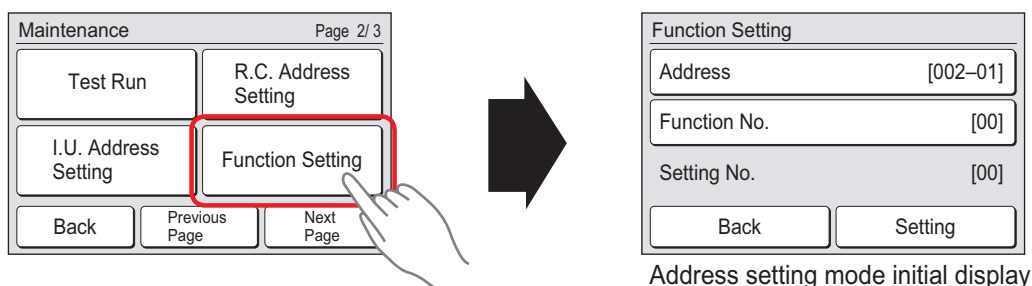

3. Touch the “Address” on the “Function Setting” screen.

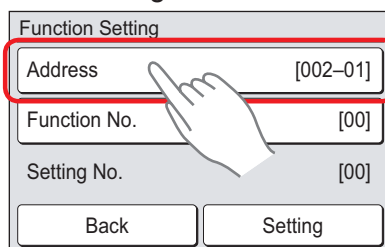

4. “Address” screen is displayed. Select the address of the indoor unit whose function number is to be set by touching ▲ or ▼. When setting at all the indoor units, touch “All”.

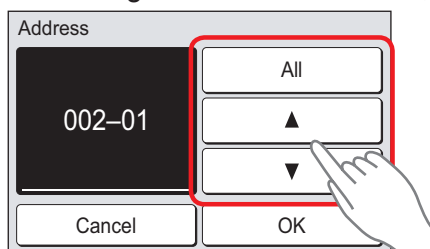

When the “OK” is touched, the display returns to the “Function Setting” screen.

5. Touch the “Function No.” on the “Function Setting” screen.

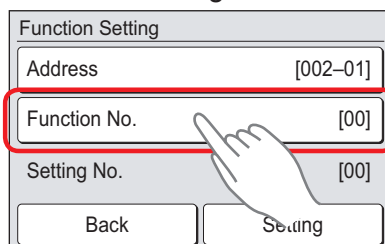

6. "Function No." screen is displayed. Set the "Function No." with ▲ or ▼.

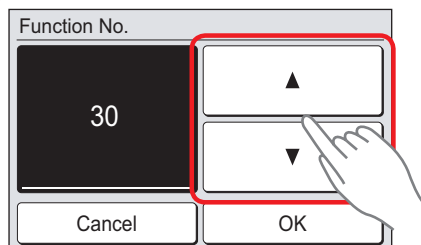

When the "OK" is touched, the display returns to the "Function Setting" screen.

7. Touch the "Function No." on the "Function Setting" screen.

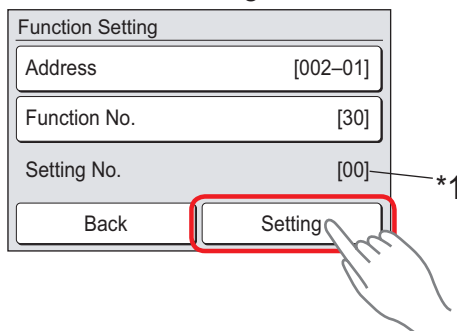

NOTE: *1: When "All" is chosen by "5", and different set up "Setting No." from two or more indoor units, "-" is displayed on "Setting No.".

8. Setting screen of "Setting No." is displayed. Set the "Function No." with ▲ or ▼.

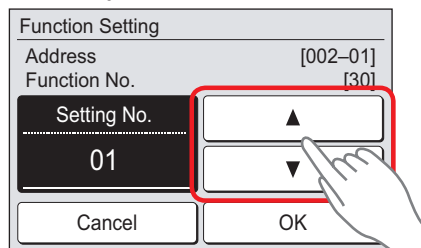

Example: Function number: 30, Setting Number: 01

When the "OK" is touched, the "Function Setting" verification screen is displayed.

9. Touch the “Yes” of the verification screen.

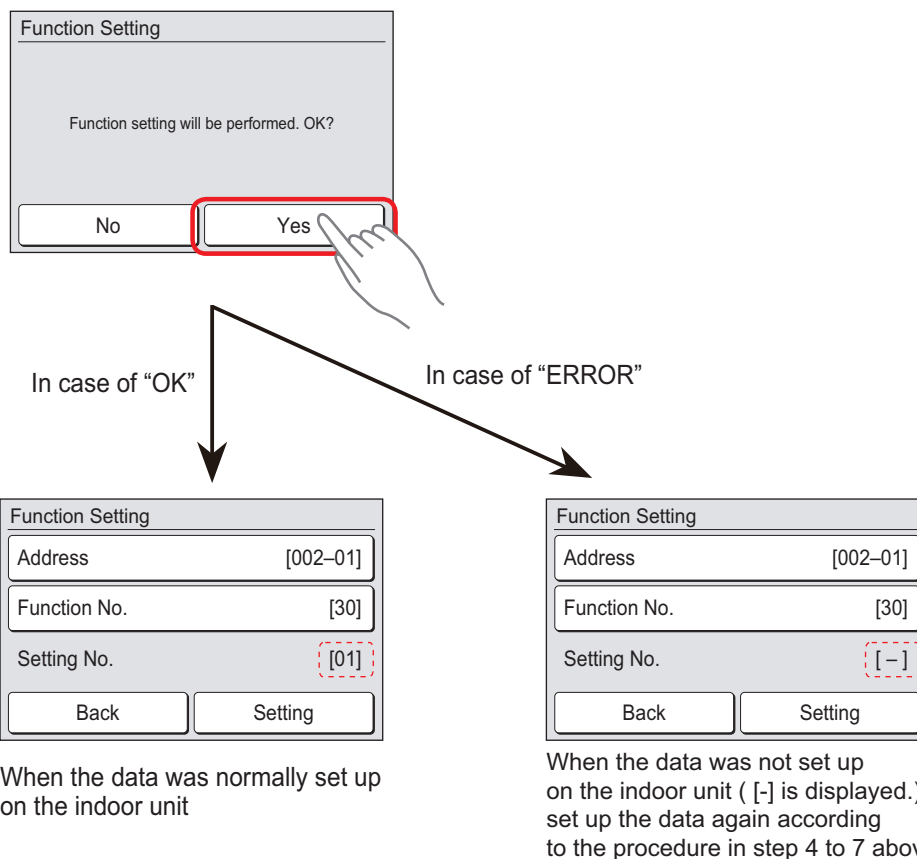

10. When the “Back” on the “Function Setting” screen is touched, the display returns to the “Maintenance” screen.

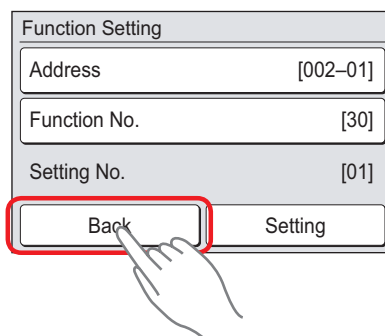

● Setting up each indoor unit

Repeat the procedure from step 1 to 6, and set up the indoor units requiring function setting.

● Resetting the power after setting up function of all indoor units

NOTES:

- If the reset is not performed, function cannot be read correctly.
- After all the functions have been set, the circuit breaker needs to be switched off for at least 2 minutes.
 - After the 2 minutes has passed, power can be restored.
 - The set function is stored in the PCB and will remain in memory even when the power of indoor unit is turned off. However setting function is effective after disconnecting the power supply and then reconnecting it.
- Record the latest configuration of the indoor unit function setting on a label, and put the label on the unit so it can be used for after-sales service operations.

14-5. Indoor unit (setting by simple remote controller)

- The function settings of the control of the indoor unit can be changed by this procedure according to the installation conditions. Incorrect settings can cause the indoor unit malfunction.
- After the power is turned on, perform the “Function setting” according to the installation conditions using the remote controller.
- The settings may be selected between the following two: Function number or Setting number.
- Settings will not be changed if invalid numbers or setting numbers are selected.
- This function cannot be used on the secondary units.

■ Preparation

Before connecting the power supply of the indoor unit, reconfirm following items:

- Piping air tight test and vacuuming have been performed firmly.
- There is no wiring mistake. Then, connect the power supply of the indoor unit.

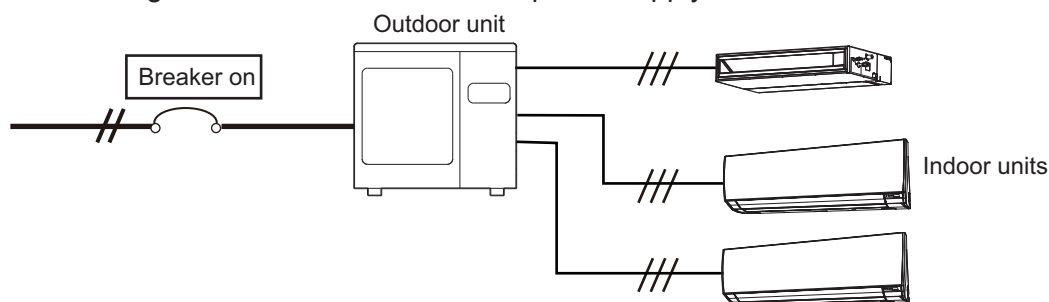

■ UTY-RSNYM

● Button name and function

During address setting mode, indoor unit reject the any operation command from remote controller.

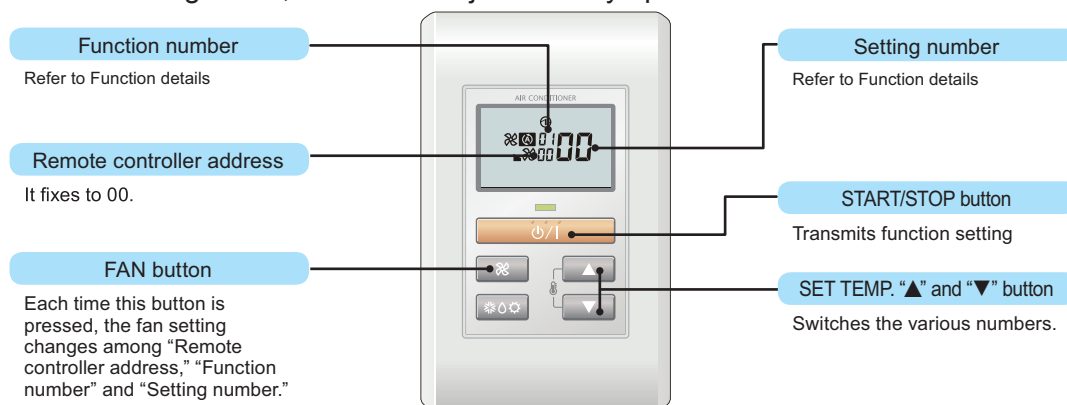

● Function setting procedure

1. Connect the power supply of the outdoor unit.
2. Switch to the function setting mode.

To enter the function setting mode, hold down the 3 buttons of SET TEMP. ▲, SET TEMP. ▼ and FAN at the same time for 5 seconds or longer.

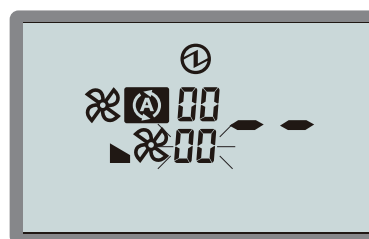
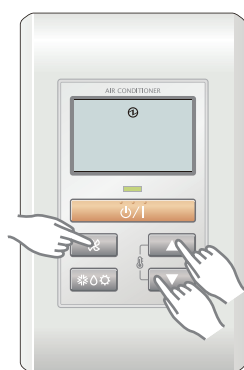

Function setting mode initial display

3. Press the FAN button.
The Function number indicator flashes. Then, press either the SET TEMP. ▲ button or the SET TEMP. ▼ button to set up the function number.

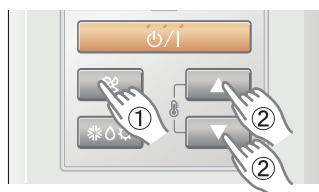

Function number

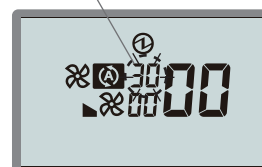

4. Select the setting number by pressing the SET TEMP. ▲ or SET TEMP. ▼ button. The setting number indicator flashes during setting number selection.

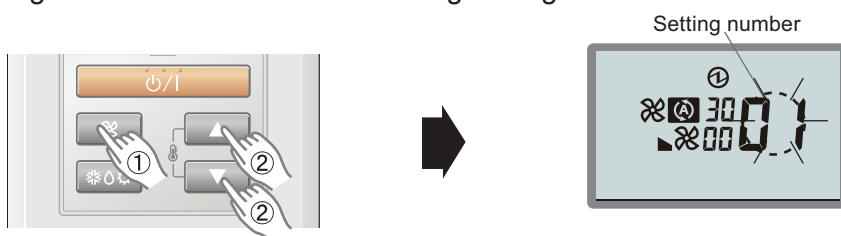

Example) Function number : 30, Setting number : 01

5. Confirm the setting by pressing the TIMER SET button. The data will be transferred to the indoor unit.

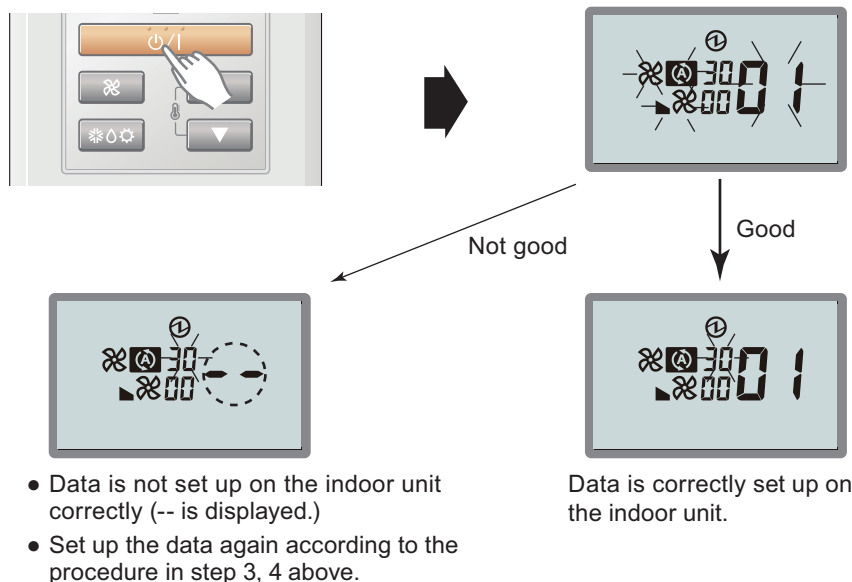

Function details: Refer to Chapter 14-6. "[Function details](#)" on page 241.

6. Exit the function setting mode by pressing the 3 buttons of SET TEMP. ▲, SET TEMP. ▼, and FAN at the same time for 5 seconds or longer. After exiting the function setting mode, the display returns to the normal mode.

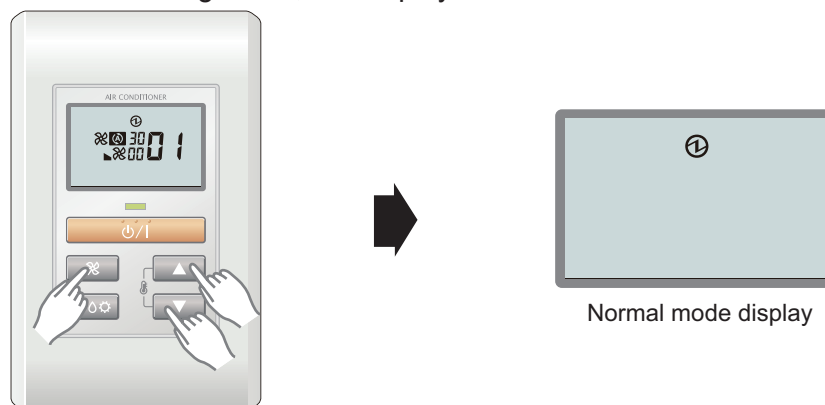

If no button is pressed within 60 seconds after buttons mentioned above are pressed, it will automatically exit the function setting mode.

If you exit the function setting mode unintentionally during setting, enter the mode again according to the procedure in step 2.

● Setting up each indoor unit

Repeat the procedures from step 1 to 6, and set up the indoor units requiring function setting.

● Resetting the power after setting up function of all indoor units

NOTES:

- If the reset is not performed, function cannot be read correctly.
- After all the functions have been set, the circuit breaker needs to be switched off for at least 2 minutes.
 - After the 2 minutes has passed, power can be restored.
 - The set function is stored in the PCB and will remain in memory even when the power of indoor unit is turned off.
However setting function is effective after disconnecting the power supply and then reconnecting it.
- Record the latest configuration of the indoor unit function setting on a label, and put the label on the unit so it can be used for after-sales service operations.

■ UTY-RSRY/UTY-RHRY

● Setting procedure by using wired remote controller

The function number and the associated setting value are displayed on the LCD of the remote controller. Follow the instructions written in the local setup procedure supplied with the remote controller, and select appropriate setting according to the installation environment.

Before connecting the power supply of the indoor unit, reconfirm following items:

- Piping air tight test and vacuuming have been performed firmly.
- There is no wiring mistake.

NOTE: Set only one Master remote controller.

1. Connect the power supply.
2. With “Monitor mode” screen displayed, press and hold the SET TEMP. \wedge button and FAN \vee button simultaneously for at least 2 seconds.

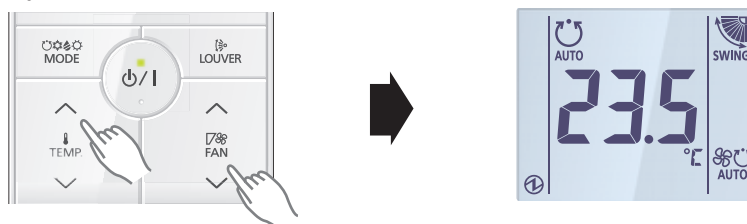

3. The Menu 1 screen is displayed. Press and hold the SET TEMP. \wedge button at least 2 seconds. Setting mode selection screen is displayed.

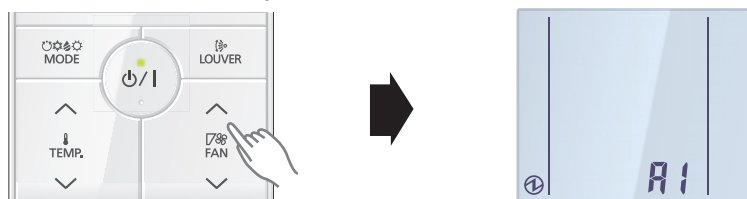

4. Press the SET TEMP. \wedge or SET TEMP. \vee button to select F1 (Menu 2-F1) setting mode or F2 (Menu 2-F2) setting mode.

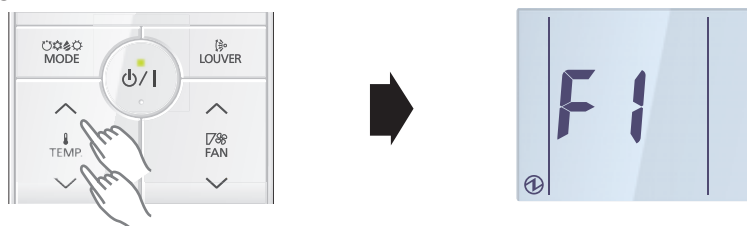

F1: Initial settings mode

F2: Maintenance settings mode

5. Press the ϕ/I button. Setting item selection screen is displayed. (Item No. is displayed.)

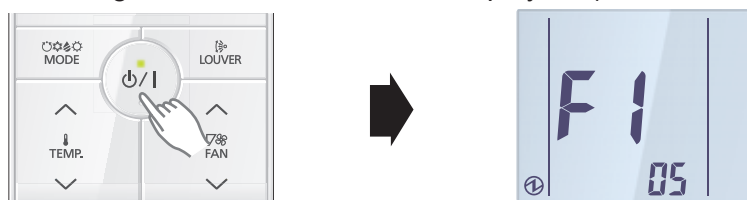

- Select the item number to be set with the SET TEMP. \wedge or SET TEMP. \vee button, and press the ϕ/I button to switch to the setting screen.

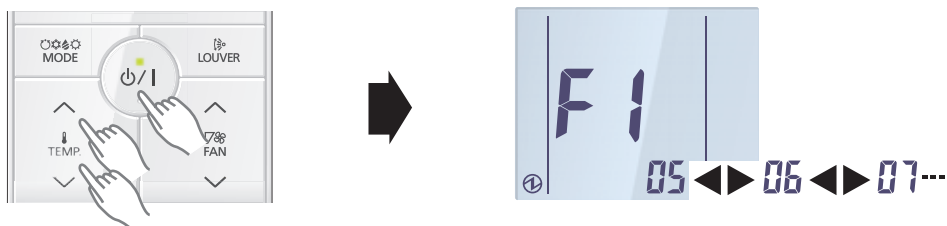

- Select the "13" in Menu 2-F1 settings. Then, press the ϕ/I button.



- Select the 2-wire remote controller address with the SET TEMP. \wedge or SET TEMP. \vee button. Then press the ϕ/I button.

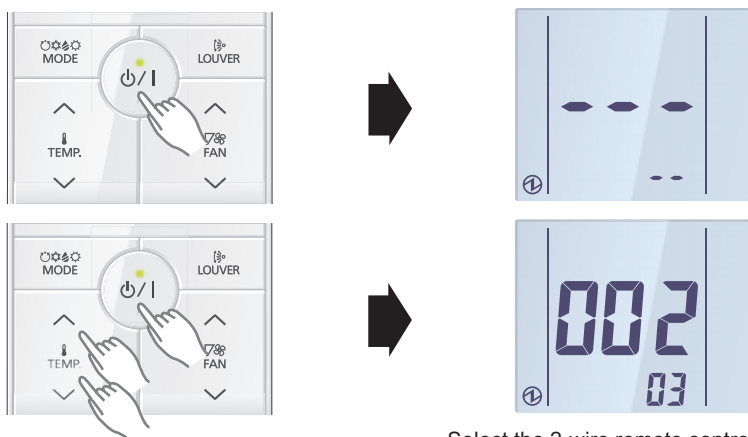

Select the 2-wire remote controller address (Ex. Select the 002-03)

- Set the function number with the SET TEMP. \wedge or SET TEMP. \vee button. Then press the ϕ/I button.

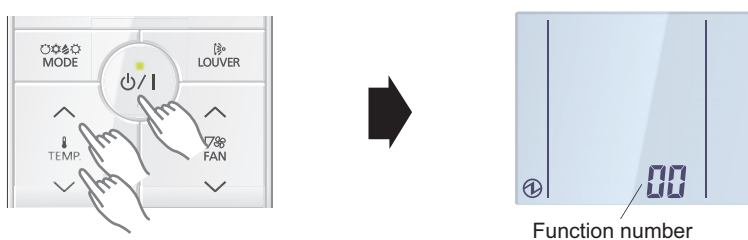

- Set the setting number with the SET TEMP. \wedge or SET TEMP. \vee button. Then press the ϕ/I button.

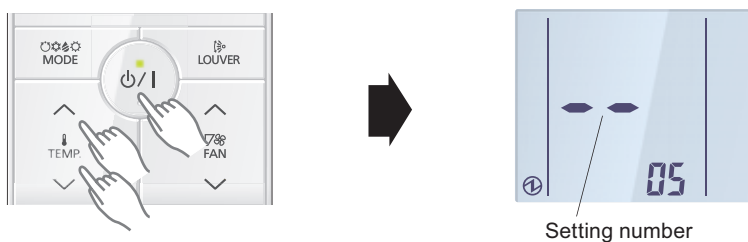

11. Setting results are displayed after data transmission.

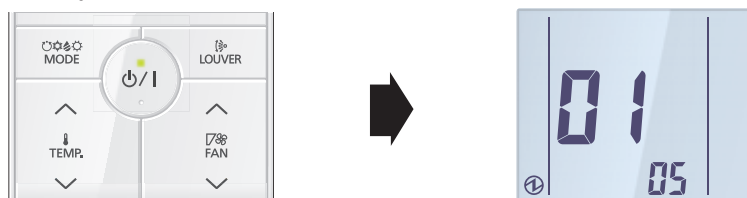

12. Press the ⏻/⏻ button to return to the 2-wire remote controller address selection screen of step 9. If setting has been completed, press the FAN ▾ button to return to the Menu 2-F1 item selection screen.

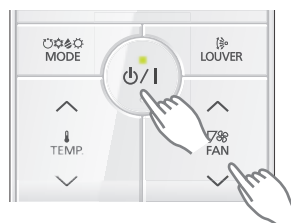

● Setting up each indoor unit

Repeat the procedure from step 1 to 6, and set up the indoor units requiring function setting.

● Resetting the power after setting up function of all indoor units

NOTES:

- If the reset is not performed, function cannot be read correctly.
- After all the functions have been set, the circuit breaker needs to be switched off for at least 2 minutes.
 - After the 2 minutes has passed, power can be restored.
 - The set function is stored in the PCB and will remain in memory even when the power of indoor unit is turned off. However setting function is effective after disconnecting the power supply and then reconnecting it.
- Record the latest configuration of the indoor unit function setting on a label, and put the label on the unit so it can be used for after-sales service operations.

14-6. Function details

■ Contents of function setting

Each function setting listed in this section is adjustable in accordance with the installation environment.

NOTE: Setting will not be changed if invalid numbers or setting values are selected.

● Function setting list

	Functions	Compact cassette	Mini duct	Slim duct	Wall mounted	Floor/Ceiling	Floor
1)	Remote controller address setting	—	—	—	●	—	●
2)	Filter sign	●	●	●	●	●	●
3)	Ceiling height	●	—	—	—	●	—
4)	Outlet directions	●	—	—	—	—	—
5)	Vertical airflow direction range control	—	—	—	—	—	●
6)	Static pressure	—	●	●	—	—	—
7)	Room temperature sensor control for cooling	●	—	●	●	●	●
8)	Room temperature sensor control for heating	●	—	●	●	●	●
9)	Room temperature control for indoor unit sensor	—	●	—	—	—	—
10)	Room temperature control for wired remote controller sensor	—	●	—	—	—	—
11)	Auto restart	●	●	●	●	●	●
12)	Room temperature sensor switching	●	●	●	●	●	●
13)	Remote controller custom code	●	●	●	●	●	●
14)	External input control	●	●	●	●	●	●
15)	Room temperature sensor switching (Aux.)	●	●	●	●	●	●
16)	Indoor unit fan control for energy saving for cooling	●	—	●	●	●	●
17)	Indoor unit fan control for energy saving for heating	—	●	—	—	—	—
18)	Switching functions for external output terminal	—	●	—	—	—	—

1) Remote controller address setting

NOTE: Because this setting is normally done automatically when 2-wire-type wired remote controller is installed, setting is unnecessary.

Multiple indoor units can be operated by using one wired remote controller.

Set the unit number of each indoor unit.

Function number	Setting value	Setting description	Factory setting
00	00	Unit no. 0	◆
	01	Unit no. 1	
	02	Unit no. 2	
	03	Unit no. 3	
	04	Unit no. 4	
	05	Unit no. 5	
	06	Unit no. 6	
	07	Unit no. 7	
	08	Unit no. 8	
	09	Unit no. 9	
	10	Unit no. 10	
	11	Unit no. 11	
	12	Unit no. 12	
	13	Unit no. 13	
	14	Unit no. 14	
	15	Unit no. 15	

NOTES:

- When connecting Polar 3-wired remote controller, set the remote controller address in the order of 0, 1, 2,, and 15.
- When different type of indoor units (such as wall mounted type and cassette type, cassette type and duct type, or other combinations) are connected using group control system, some functions may no longer be available.

2) Filter sign

Select appropriate intervals for displaying the filter sign on the indoor unit according to the estimated amount of dust in the air of the room.

If the indication is not required, select "No indication" (03).

Function number	Setting value	Setting description	Factory setting
11	00	Standard	
	01	Long interval	
	02	Short interval	
	03	No indication	◆

Intervals will differ depending on the indoor unit type as follows.

Setting description	Compact cassette	Slim duct Mini duct	Wall mounted	Floor	Floor/Ceiling
Standard	2,500 hours		400 hours		
Long interval	4,400 hours		1,000 hours		
Short interval	1,250 hours		200 hours		

3) Ceiling height

Select the appropriate ceiling height according to the place of installation.

Function number	Setting value	Setting description	Factory setting
20	00	Standard	◆
	01	High ceiling	

For the specific height for each setting value, refer to "Installation space" in Chapter 3. "[Dimensions](#)" on page 21.

In case of cassette type models:

The ceiling height values are for the 4-way outlet. Do not change this setting in the 3-way outlet mode.

7000, 9000 Btu/h models cannot be installed in high ceilings. Do not change this setting.

4) Outlet directions

Select the appropriate number of outlet directions according to the installation conditions.

Function number	Setting value	Setting description	Factory setting
22	00	4-way	◆
	01	3-way	

5) Vertical airflow direction range control

In a concealed installation, change the setting to "Fixed" (02) to restrict the movement of the upper air outlet so that the airflow is only towards the horizontal direction.

Function number	Setting value	Setting description	Factory setting
23	00	Standard	◆
	01	(Setting prohibited)	
	02	Fixed (Concealed)	

6) Static pressure

Select the appropriate static pressure according to the installation conditions.

For mini duct type:

Function number	Setting value	Setting description	Factory setting
26	00	0 Pa	
	01	10 Pa	
	02	20 Pa	
	03	30 Pa	
	04	40 Pa	
	05	50 Pa	
	31	Standard (10 Pa: 07, 09, 12 type, 15 Pa: 14, 18 type)	◆

NOTES:

- Range of static pressure is different by model.

Model name	Range of static pressure
07 type	0 to 30 Pa
09 type	
12 type	
14 type	0 to 50 Pa
18 type	

- Setting number in 07, 09, or 12 type is "04 to 30": Operation is same as that "03".
- Setting number in 14 or 18 type is "06 to 30": Operation is same as that "05".
- Setting number value cannot be set to 32 or more.

For slim duct type:

Function number	Setting value	Setting description	Factory setting
26	00	0 Pa	
	01	10 Pa	
	02	20 Pa	
	03	30 Pa	
	04	40 Pa	
	05	50 Pa	
	06	60 Pa	
	07	70 Pa	
	08	80 Pa	
	09	90 Pa	
	31	Standard (25 Pa)	◆

7) Room temperature sensor control for cooling (for other than Mini duct type)

Depending on the installed environment, correction of the room temperature sensor may be required. Select the appropriate control setting according to the installed environment.

Function number	Setting value	Setting description	Factory setting
30	00	Standard	◆
	01	Slightly lower control	
	02	Lower control	
	03	Higher control	

In case of Slim duct type and Floor/Ceiling type models:

In wall-concealed installations or floor installations, select "01".

8) Room temperature sensor control for heating (for other than Mini duct type)

Depending on the installed environment, correction of the room temperature sensor may be required. Select the appropriate control setting according to the installed environment.

Function number	Setting value	Setting description	Factory setting
31	00	Standard	◆
	01	Lower control	
	02	Slightly higher control	
	03	Higher control	

In case of Slim duct type and Floor/Ceiling type models:

In wall-concealed installations or floor installations, select "01".

9) Room temperature control for indoor unit sensor (for Mini duct type only)

Depending on the installed environment, correction of the room temperature sensor may be required. Select the appropriate control setting according to the installed environment.

The temperature correction values show the difference from the Standard setting "00" (manufacturer's recommended value).

Function number	Setting value	Setting description	Factory setting		
30 (For cooling)	31 (For heating)	00	Standard setting	◆	
		01	No correction 0.0 °C		
		02	-0.5 °C	More cooling Less heating	
		03	-1.0 °C		
		04	-1.5 °C		
		05	-2.0 °C		
		06	-2.5 °C		
		07	-3.0 °C		
		08	-3.5 °C		
		09	-4.0 °C		
		10	+0.5 °C	Less cooling More heating	
		11	+1.0 °C		
		12	+1.5 °C		
		13	+2.0 °C		
		14	+2.5 °C		
		15	+3.0 °C		
		16	+3.5 °C		
17	+4.0 °C				

In case of Slim duct type and Floor/Ceiling type models:

In wall-concealed installations or floor installations, select "01".

10) Room temperature control for wired remote controller sensor (for Mini duct type only)

Depending on the installed environment, correction of the wire remote temperature sensor may be required. Select the appropriate control setting according to the installed environment.

To change this setting, set Function 42 to Both "01".

Ensure that the Thermo Sensor icon is displayed on the remote controller screen.

Function number		Setting value	Setting description	Factory setting	
35 (For cooling)	36 (For heating)	00	No correction	◆	
		01	No correction 0.0°C		
		02	-0.5 °C	More cooling Less heating	
		03	-1.0 °C		
		04	-1.5 °C		
		05	-2.0 °C		
		06	-2.5 °C		
		07	-3.0 °C		
		08	-3.5 °C		
		09	-4.0 °C		
		10	+0.5 °C	Less cooling More heating	
		11	+1.0 °C		
		12	+1.5 °C		
		13	+2.0 °C		
		14	+2.5 °C		
		15	+3.0 °C		
		16	+3.5 °C		
17	+4.0 °C				

11) Auto restart

Enables or disables automatic restart after a power interruption.

Function number	Setting value	Setting description	Factory setting
40	00	Enable	◆
	01	Disable	

NOTE: Auto restart is an emergency function such as for power outage etc. Do not attempt to use this function in normal operation. Be sure to operate the unit by remote controller or external device.

12) Room temperature sensor switching

(Only for wired remote controller)

When using the wired remote controller temperature sensor, change the setting to "Both" (01).

Function number	Setting value	Setting description	Factory setting
42	00	Indoor unit	◆
	01	Both	

00: Sensor on the indoor unit is active.

01: Sensors on both indoor unit and wired remote controller are active.

NOTE: Remote controller sensor must be turned on by using the remote controller.

13) Remote controller custom code

(Only for wireless remote controller)

The indoor unit custom code can be changed. Select the appropriate custom code.

Function number	Setting value	Setting description	Factory setting
44	00	A	◆
	01	B	
	02	C	
	03	D	

14) External input control

"Operation/Stop" mode or "Forced stop" mode can be selected.

Function number	Setting value	Setting description	Factory setting
46	00	Operation/Stop mode 1	◆
	01	(Setting prohibited)	
	02	Forced stop mode	
	03	Operation/Stop mode 2 (for Mini duct type only)	

15) Room temperature sensor switching (Aux.)

To use the temperature sensor on the wired remote controller only, change the setting to "Wired remote controller" (01).

This function will only work if the function setting 42 is set at "Both" (01).

When the setting value is set to "Both" (00), more suitable control of the room temperature is possible by setting function setting 30 and 31 too.

Function number	Setting value	Setting description	Factory setting
48	00	Both	◆
	01	Wired remote controller	

16) Indoor unit fan control for energy saving for cooling (for other than Mini duct type)

Enables or disables the power-saving function by controlling the indoor unit fan rotation when the outdoor unit is stopped during cooling operation.

Function number	Setting value	Setting description	Factory setting
49	00	Disable	◆
	01	Enable	

00: When the outdoor unit is stopped, the indoor unit fan operates continuously following the setting on the remote controller.

01: When the outdoor unit is stopped, the indoor unit fan operates intermittently at a very low speed.

17) Indoor unit fan control for energy saving for cooling (for Mini duct type only)

Enables or disables the power-saving function by controlling the indoor unit fan rotation when the outdoor unit is stopped during cooling operation.

Function number	Setting value	Setting description	Factory setting
49	00	Disable	
	01	Enable	
	02	Remote controller	◆

00: When the outdoor unit is stopped, the indoor unit fan operates continuously following the setting on the remote controller.

01: When the outdoor unit is stopped, the indoor unit fan operates intermittently at a very low speed.

02: Enable or disable this function by remote controller setting.

NOTES:

- As the factory setting, this setting is initially activated.
- Set to "00" or "01" when connecting a remote controller that cannot set the Fan control for energy saving function or connecting a network converter.
To confirm if the remote controller has this setting, refer to the operating manual of each remote controller.

18) Switching functions for external output terminal

Functions of the external output terminal can be switched. For details, refer to "External input and output".

Function number	Setting value	Setting description	Factory setting
60	00	Operation status	◆
	01—08	(Setting prohibited)	
	09	Error status	
	10	Indoor unit fan operation status	
	11	External heater	

14-7. Wired remote controller (UTY-RNNYM)

DIP switch 1	SW1	Prohibited
	SW2	Dual remote controller setting
	SW3	Prohibited
	SW4	°F/°C switch
	SW5	Prohibited
	SW6	Memory backup setting

* Do not use DIP switch 2.

■ Switch location

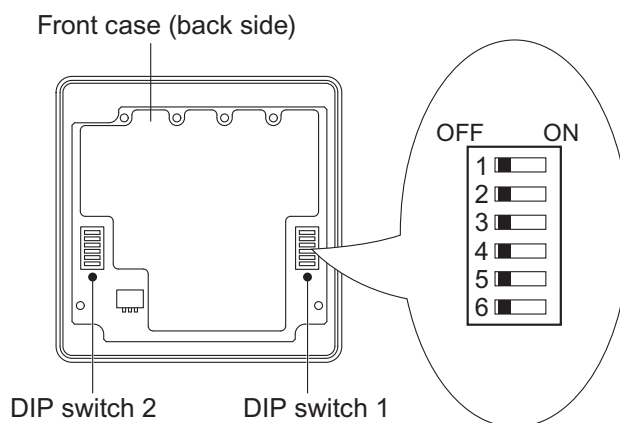

■ DIP switch 1 setting

● SW2: Dual remote controller setting

Set the remote controller SW2 according to the following table.

Number of remote controller	Primary unit	Secondary unit	Factory setting
	SW2	SW2	
1 (Normal)	OFF	—	◆
2 (Dual)	OFF	ON	

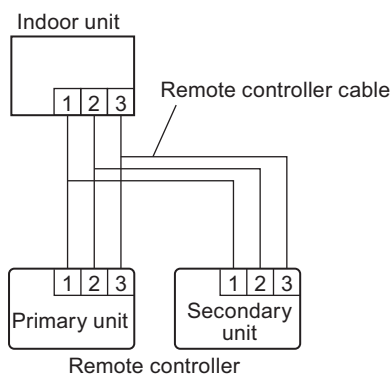

● SW4: Switching temperature unit °F / °C

Displayed temperature unit can be switched between Fahrenheit (°F) and Celsius (°C).

SW4	Fahrenheit (°F) / Celsius (°C)	Factory setting
OFF	°C	◆
ON	°F	

● SW6: Memory backup setting

Set to "ON" to use batteries for the memory backup.

When batteries are not used, all of settings stored in memory will be deleted if there is a power failure.

SW6	Memory backup	Factory setting
OFF	Disable	◆
ON	Enable	

14-8. Wired remote controller (UTY-RVNYM)

DIP switch 1	SW1	Memory backup setting
	SW2	Dual remote controller setting

■ Switch location

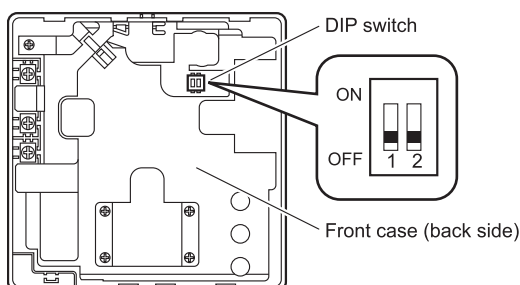

■ DIP switch setting

● SW1: Memory backup setting (only for wired remote controller)

Set to "ON" to use batteries for the memory backup.

When batteries are not used, all of settings stored in memory will be deleted if there is a power failure.

SW1	Memory backup	Factory setting
OFF	Disable	◆
ON	Enable	

NOTE: Never turn it on in the case of simple remote controller.

● SW2: Dual remote controller setting

Set the remote controller SW2 according to the following table.

Number of remote controller	Primary unit	Secondary unit	Factory setting
	SW2	SW2	
1 (Normal)	OFF	—	◆
2 (Dual)	OFF	ON	

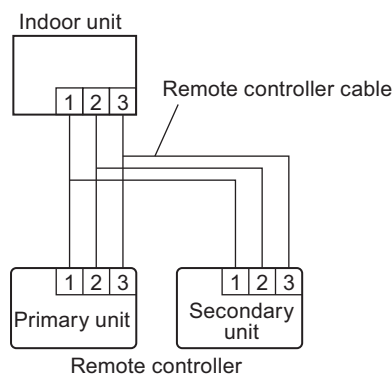

14-9. Wired remote controller (UTY-RLRY)

DIP switch	SW1	Memory backup setting
------------	-----	-----------------------

■ Switch location

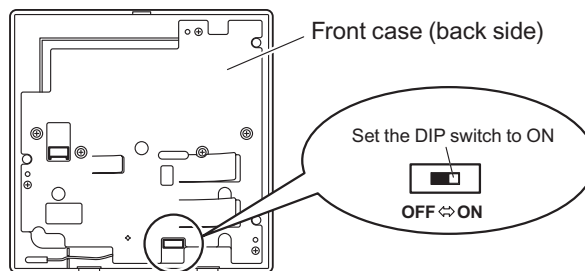

■ Dip switch setting

● SW1: Memory backup setting (only for wired remote controller)

Set to "ON" to use batteries for the memory backup.

When batteries are not used, all of settings stored in memory will be deleted if there is a power failure.

SW1	Memory backup	Factory setting
OFF	Disable	◆
ON	Enable	

NOTE: Never turn it on in the case of simple remote controller.

14-10. Wired remote controller (UTY-RNRYZ*)

DIP switch	SW1	Memory backup setting
------------	-----	-----------------------

■ Switch location

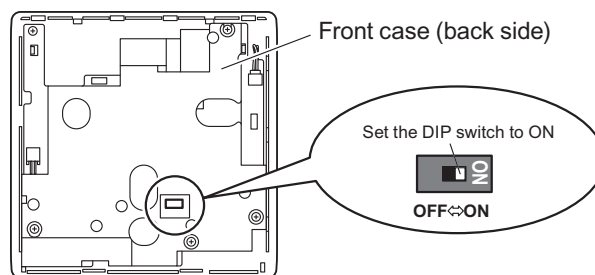

■ Dip switch setting

● SW1: Memory backup setting (only for wired remote controller)

Set to "ON" to use batteries for the memory backup.

When batteries are not used, all of settings stored in memory will be deleted if there is a power failure.

SW1	Memory backup	Factory setting
OFF	Disable	◆
ON	Enable	

NOTE: Never turn it on in the case of simple remote controller.

14-11. Simple remote controller (UTY-RSNYM)

DIP switch	SW1	Prohibited
	SW2	Dual remote controller setting
	SW3	°F/°C switch
	SW4	Prohibited
	SW5	Prohibited
	SW6	Prohibited

■ Switch location

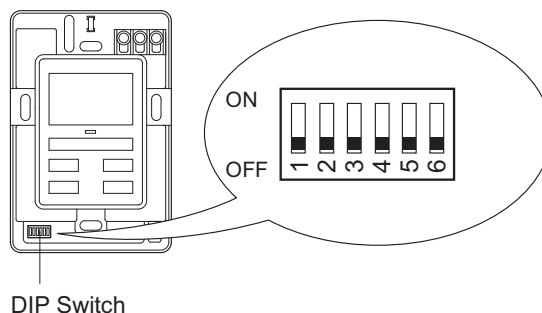

■ DIP switch setting

● SW2: Dual remote controller setting

Set the remote controller SW2 according to the following table.

Number of remote controller	Primary unit	Secondary unit	Factory setting
	SW2	SW2	
1 (Normal)	OFF	—	◆
2 (Dual)	OFF	ON	

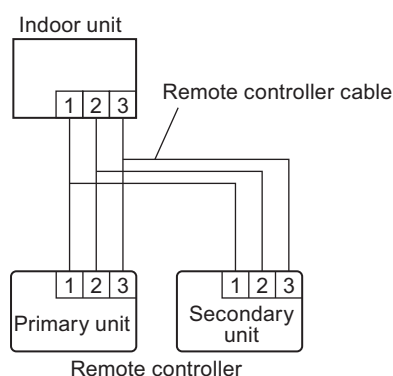

● SW3: Switching temperature unit °F / °C













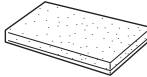

Displayed temperature unit can be switched between Fahrenheit (°F) and Celsius (°C).

SW3	Fahrenheit (°F) / Celsius (°C)	Factory setting
OFF	°C	◆
ON	°F	

15. Accessories



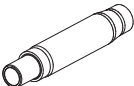









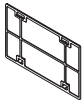

15-1. Compact cassette type

■ Models: AUYG07LVLA, AUYG09LVLA, AUYG12LVLB, AUYG14LVLB, and AUYG18LVLB

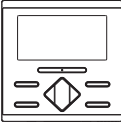
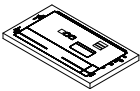
Part name	Exterior	Q'ty	Part name	Exterior	Q'ty
Operating manual		1	Hose band		1
Installation manual		1	Drain hose insulation		1
Coupler heat insulation (Large)		1	Remote controller		1
Coupler heat insulation (Small)		1	Remote controller holder		1
Special nut A (Large flange)		4	Battery		2
Special nut B (Small flange)		4	Tapping screw		2
Template (Carton top)		1	Cable tie		2
Drain hose		1	Wire clammer		1



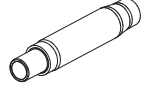









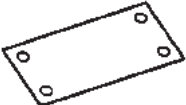
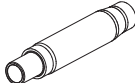

15-2. Mini duct type

■ Models: ARYG07LSLAP, ARYG09LSLAP, ARYG12LSLAP, ARYG14LSLAP, and ARYG18LSLAP

Part name	Exterior	Q'ty	Part name	Exterior	Q'ty
Installation manual (Indoor unit)		1	Cable tie (large)		4
Operating manual (Indoor unit)		1	Cable tie (medium)		2
Installation manual (Wired remote controller)		1	Filter (small) (For 07/09/12/14 models)		2
Operating manual (Wired remote controller)		1	Filter (big) (For 18 model)		2
Operating manual (CD-ROM)		1	Wired remote controller (2-wire type)		1
Template (Carton top)		1	Remote controller accessories	—	1 set
Washer		8	Drain hose insulation B		1
Coupler heat insulation (large)		1	Drain hose		1
Coupler heat insulation (small)		1	Hose band		1











15-3. Slim duct type

■ Models: ARYG07LLTA, ARYG09LLTA, ARYG12LLTB, ARYG14LLTB, and ARYG18LLTB

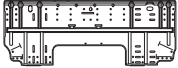





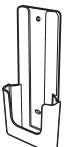

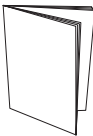

Part name	Exterior	Q'ty	Part name	Exterior	Q'ty
Operating manual		1	Cable tie (large)		4
Installation manual		1	Cable tie (medium)		3
Installation template		1	Drain hose		1
Washer		8	Hose band		1
Coupler heat insulation (large)		1	Drain hose insulation B		1
Coupler heat insulation (small)		1	Remote controller		1
Filter (Small) (For 07/09/12/14 models)		2	Tapping screw		2
Filter (Big) (For 18 model)		2	Remote controller cable		1

15-4. Wall mounted type

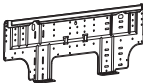



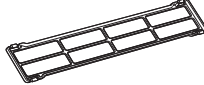



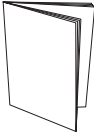

■ Models: ASYG07LUCA, ASYG09LUCA, ASYG12LUCA, and ASYG14LUCA

Part name	Exterior	Q'ty	Part name	Exterior	Q'ty
Operating manual		1	Cloth tape		1
Installation manual		1	Tapping screw (large)		5
Wall hook bracket		1	Tapping screw (small)		2
Remote controller		1	Air cleaning filter		2
Battery		2	Seal A • It is necessary when using AS14. • It is used when the diameter of gas pipe is $\varnothing 12.70$ or more.		1
Remote controller holder		1			

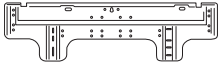
■ **Models: ASYG07LMCA, ASYG09LMCA, ASYG12LMCA, ASYG14LMCA, ASYG07LMCE, ASYG09LMCE, ASYG12LMCE and ASYG14LMCE**





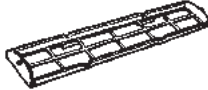







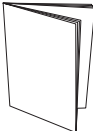



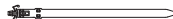
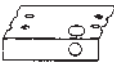

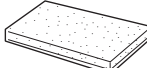

Part name	Exterior	Q'ty	Part name	Exterior	Q'ty
Operating manual		1	Cloth tape		1
Installation manual		1	Tapping screw (large)		5
Wall hook bracket		1	Tapping screw (small)		2
Remote controller		1	Air cleaning filter		2
Battery		2	Filter holder		2
Remote controller holder		1	Seal A <ul style="list-style-type: none"> • It is necessary when using 14 model. • It is used when the diameter of gas pipe is $\varnothing 12.70$ or more. 		1

■ Models: ASYG18LFCA, ASYG24LFCA, and ASYG24LFCC

Part name	Exterior	Q'ty	Part name	Exterior	Q'ty
Operating manual		1	Drain hose insulation		1
Installation manual		1	Cloth tape		1
Wall hook bracket		1	Tapping screw (large)		8
Remote controller		1	Tapping screw (small)		2
Battery		2	Air cleaning filter		2
Remote controller holder		1	Air cleaning filter frame		2









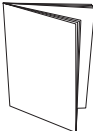

15-5. Floor/Ceiling type

■ Models: ABYG14LVTA and ABYG18LVTB

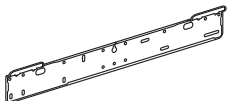
Part name	Exterior	Q'ty	Part name	Exterior	Q'ty
Operating manual		1	Special nut For suspending the indoor unit from ceiling		4
Installation manual		1	Cable tie (Large) For fixing the drain hose		1
Cover plate (Left)		1	Cable tie (Small) For electrical wiring		2
Cover plate (Right)		1	Wire clammer For electrical wiring		1
Installation template Positioning for under ceiling type		1	Drain hose		1
Bracket (Left) For suspending the indoor unit from ceiling		1	Drain hose insulation Adhesive type 100 × 220 mm		1
Bracket (Right) For suspending the indoor unit from ceiling		1	Hose band For installing drain hose		1
Wall bracket For suspending the indoor unit on the wall		2	VT wire For fixing the drain hose L = 280 mm		1
Tapping screw		2	Remote controller		1
Tapping screw For fixing the wall bracket		6	Battery		2
Coupler heat insulator (Large) For indoor side pipe joint (Large pipe)		1	Remote controller holder		1
Coupler heat insulator (Small) For indoor side pipe joint (Small pipe)		1	Tapping screw For remote controller holder installation		2

15-6. Floor type

■ Models: AGYG09LVCA, AGYG12LVCA, and AGYG14LVCA

Part name	Exterior	Q'ty	Part name	Exterior	Q'ty
Operating manual		1	Remote controller holder		1
Installation manual		1	Cloth tape		1
Wall hook bracket		1	Tapping screw (large)		9
Remote controller		1	Tapping screw (small)		2
Battery		2	Air cleaning filter		2

16. Optional parts

16-1. Controllers









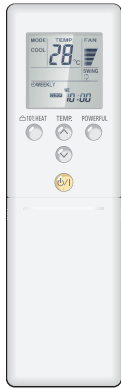

■ Lineup

Indoor unit type		Type							
		Wireless remote controller				Wired remote controller			
		AR-RAH2E	AR-RAH1E	AR-REA2E	AR-REB1E	UTY-RNNYM	UTY-RVNYM	UTY-RLRY	UTY-RNRYZ*
Compact cassette		—	●	—	—	○	○	—	—
Mini duct		—	—	—	—	○	○	●	○
Slim duct		—	—	—	—	●	○	—	—
Wall mounted	LU	—	—	●	—	○*1	○*1	—	—
	LM	—	—	—	●	○*2	○*2	—	—
	LF	●	—	—	—	○	○	—	—
Floor/Ceiling		●	—	—	—	○	○	—	—
Floor		—	●	—	—	○	○	—	—

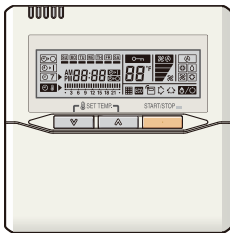
Indoor unit type		Type				
		IR receiver kit with Wireless remote controller		Simple remote controller		
		UTY-LRHYM	UTY-LBTYM	UTY-RSNYM	UTY-RSRY	UTY-RHRY
Compact cassette		—	—	○	—	—
Mini duct		—	○	○	○	○
Slim duct		○	—	○	—	—
Wall mounted	LU	—	—	○*1	—	—
	LM	—	—	○*2	—	—
	LF	—	—	○	—	—
Floor/Ceiling		—	—	○	—	—
Floor		—	—	○	—	—

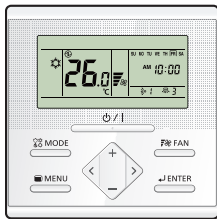
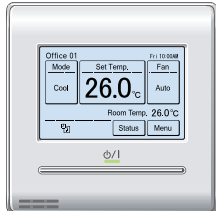
- : Accessory, ○: Optional, —: Not applicable
- *1: Optional Communication kit (UTY-TWBXF) is necessary for the installation.
- *2: Optional Communication kit (UTY-XCBXZ2) is necessary for the installation.

Parts

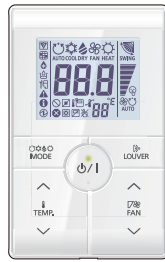
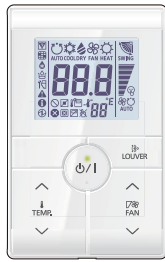
Wireless remote controller				
				
AR-RAH2E	AR-RAH1E	AR-REA2E	AR-REB1E	
Wired remote controller				
				
UTY-RNNYM	UTY-RVNYM	UTY-RLRY	UTY-RNRYZ*	
IR receiver kit with Wireless remote controller		Simple remote controller		
				
UTY-LRHYM	UTY-LBTYM	UTY-RSNYM	UTY-RSRY	UTY-RHRY

16-2. Cassette grille

■ Lineup

Indoor unit type	Model
Compact cassette	UTG-UFYD-W

■ Part

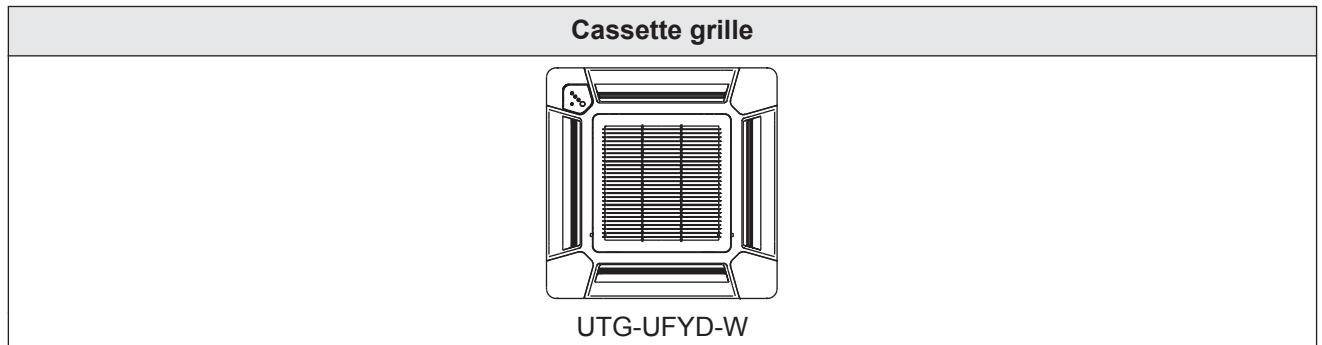

16-3. Others

■ Lineup

Indoor unit type		Type					
		Air outlet shutter plate	Insulation kit for high humidity	Fresh air intake kit	External control set	External switch controller	Auto louver grille kit
		UTR-YDZB	UTZ-KXGC	UTZ-VXAA	UTD-ECS5A	UTY-TERX	UTD-GXTA-W UTD-GXTB-W
Compact cassette		○	○	○	—	—	—
Mini duct		—	—	—	—	○	○
Slim duct		—	—	—	○	—	○
Wall mounted	LU	—	—	—	—	—	—
	LM	—	—	—	—	—	—
	LF	—	—	—	—	—	—
Floor/Ceiling		—	—	—	—	—	—
Floor		—	—	—	—	—	—

Indoor unit type		Type						
		External connect kit			Split system converter		KNX converter	MODBUS converter
		UTY-XWZX	UTY-XWZXZ5	UTY-XWZXZG	UTY-VTGX	UTY-VTGXV	UTY-VKSX	UTY-VMSX
Compact cassette		○	—	—	○	○	—	—
Mini duct		—	—	○	○	○	○	○
Slim duct		—	—	—	○	○	—	—
Wall mounted	LU	—	○*1	—	○*1	○*1	—	—
	LM	—	○*2	—	○*2	○*2	—	—
	LF	○	—	—	○	○	—	—
Floor/Ceiling		○	—	—	○	○	—	—
Floor		○	—	—	○	○	—	—

Indoor unit type		Type					
		Remote sensor unit	Communication kit		Half concealed kit	Wireless LAN interface ^{*3}	
		UTY-XSZX	UTY-XCBXZ2	UTY-TWBXF	UTR-STA	UTY-TFNXZ1	UTY-TFSXZ1
Compact cassette		—	—	—	—	○	—
Mini duct		○	—	—	—	—	○
Slim duct		○	—	—	—	○	—
Wall mounted	LU	—	—	○	—	○*1	—
	LM	—	○	—	—	○*2	—
	LF	—	—	—	—	○	—
Floor/Ceiling		—	—	—	—	○	—
Floor		—	—	—	○	○	—

●: Accessory, ○: Optional, —: Not applicable









• *1: Optional Communication kit (UTY-TWBXF) is necessary for the installation.

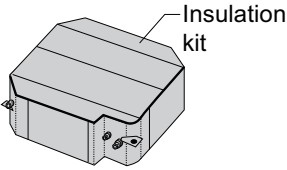

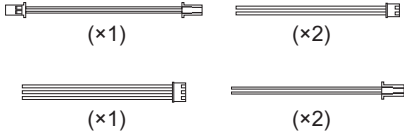

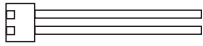
• *2: Optional Communication kit (UTY-XCBXZ2) is necessary for the installation.

• *3: For details of WLAN control, refer to “Design & Technical manual” or “Setting manual” of WLAN control system.

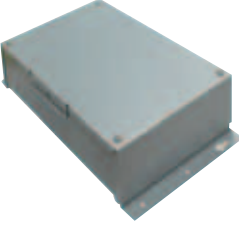
NOTE: Combined use of MODBUS converter, KNX converter, and Wireless LAN interface (UTY-TFSXZ1 only) is not allowed.

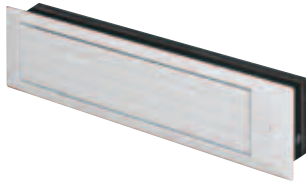
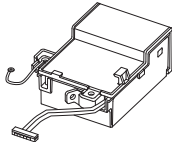
Parts

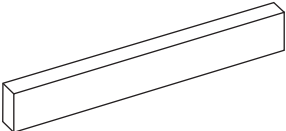
<p>Air outlet shutter plate Model: UTR-YDZB</p>  <p>For compact cassette type</p>	<p>Insulation kit for high humidity Model: UTZ-KXGC</p>  <p>For compact cassette type</p>
<p>Fresh air intake kit Model: UTZ-VXAA</p>  <p>For compact cassette type</p>	<p>External control set Model: UTD-ECS5A</p>  <p>For slim duct type</p>
<p>External connect kit Model: UTY-XWZX</p>  <p>For compact cassette type, wall mounted type (LF), floor/ceiling type, and floor type</p>	<p>External connect kit Model: UTY-XWZXZ5</p>  <p>For wall mounted (LU, LM) type</p>
<p>External connect kit Model: UTY-XWZXZG</p>  <p>For mini duct type</p>	<p>MODBUS converter Model: UTY-VMSX</p>  <p>For mini duct type</p>
<p>KNX converter Model: UTY-VKSX</p>  <p>For mini duct type</p>	<p>External switch controller Models: UTY-TERX</p>  <p>For mini duct type</p>
<p>Split system converter Model: UTY-VTGX</p> 	<p>Split system converter Model: UTY-VTGXV</p> 

<p>Remote sensor unit Model: UTY-XSZX</p>	<p>Auto louver grille kit Models: UTD-GXTA-W *1, UTD-GXTB-W*2</p>
<p style="text-align: center;"></p> <p style="text-align: center;">For slim duct type and mini duct type</p>	<p style="text-align: center;"></p> <p style="text-align: center;">*1: For slim duct type and mini duct type (07-14 models) *2: For slim duct type and mini duct type (18 models)</p>
<p>Communication kit Model: UTY-XCBXZ2</p>	<p>Communication kit Model: UTY-TWBXF</p>
<p style="text-align: center;"></p> <p style="text-align: center;">For wall mounted (LM) type</p>	<p style="text-align: center;"></p> <p style="text-align: center;">For wall mounted (LU) type</p>
<p>Half concealed kit Model: UTR-STA</p>	<p>Wireless LAN interface Model: UTY-TFNXZ1*1, UTY-TFSXZ1*2</p>
<p style="text-align: center;"></p> <p style="text-align: center;">For floor type</p>	<p style="text-align: center;"></p> <p style="text-align: center;">*1: For compact cassette type, slim duct type, wall mounted type, floor/ceiling type, and floor type *2: For mini duct type</p>

17. Indoor unit installation precautions

NOTE: The information listed below are general precautions.
Some models also include items that do not apply.

17-1. Places where prohibited for use

- Places where there is a danger of combustible gas leakage.
- Places where sulfur gas, chlorine gas, acid, alkali, or other matter which effects equipment is generated.
- Places where there is a lot of oil splash and steam such as kitchen or machinery room.
- Places where machinery which generates high frequencies is used.
- Ocean beaches and other areas where there is a lot of salt.
- Places where carbon fibers or any kind of powder suspended in the air.
- Inside of vehicles, ships, and other conveyances.
- Places where voltage fluctuations are large such as a factory.

17-2. Points to remember when installing

- The product shall be installed at a place which can withstand the weight and vibration of the indoor.
- To allow maintenance after refrigerant piping, drain piping, and electric wiring connection and installation, provide an installation service space and an inspection port, as required.
*Installation service space is shown on "Dimensions" on page 21.
- Be careful when installing the unit at the following places.

Condition	Contents	Countermeasures (Reference)
When the ceiling is high.	If the indoor unit is installed where the installation height given in the installation manual is exceeded, the temperature difference between the floor and ceiling of the room will be large and the heating effect will be poor. Moreover, even if the indoor unit is installed within the installation height, a similar phenomena will occur when installed in a room in which the doors are opened and closed frequently and hot air circulation is obstructed by furniture such as desks or chairs.	1. Switch the setting to the high ceiling mode. 2. Install a circulator. 3. Arrange the furniture in the room so that it does not obstruct the hot air.
When lower level directly contacts the outside air.	When the lower level of the room is a semi-open space such as warehouse or parking lot the surface temperature of the flooring will become low and the radiation of cold from the floor will increase. In this case, even if the room temperature is suitable, you may feel the foot level is cold.	
When the airflow distribution is poor.	When an indoor unit is installed in a position where the outlet airflow will directly contact people, a draft may be felt. In addition, when there are obstructions in the path of the intake and outlet airflow, the air distribution may become extremely bad.	1. Adjust the louver fins or take other measures matched to the site. 2. Change the indoor unit outlet.
When inside the ceiling is high temperature and high humidity.	When the indoor unit is installed where the inside of the ceiling is 30 °C (86 °F) RH80% or greater, the dew point temperature of the outer perimeter may become higher than the cabinet surface temperature and moisture will condense on the surface of the cabinet and water drops may fall inside the room. →Refer to Fig. A. In addition, the humidity may vary considerably the same as when the inside of the ceiling is close to hermetically sealed and used as the outside air intake path.	1. Add heat insulating material to the outside of the indoor unit cabinet. *Regarding the cassette type, use of optional High humidity correspondence kit is recommended. 2. Strengthen the heat insulating material of the refrigerant piping and drain piping too. →Refer to Fig. B. 3. When the humidity inside the ceiling changes considerably, install a ventilation port.

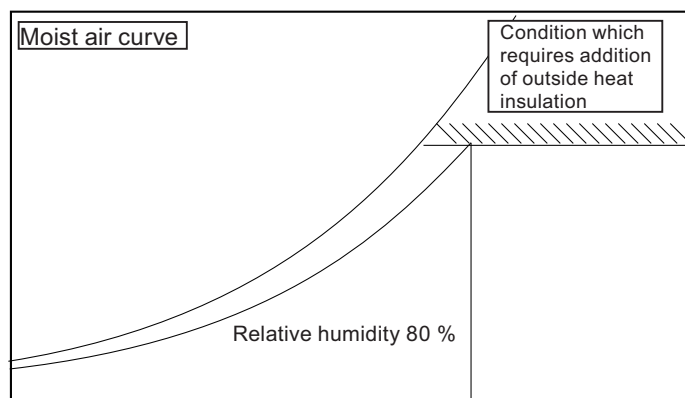

Dry bulb temperature 30 °C (86 °F)

Fig. A

Work method when reinforcing the heat insulation of on-site piping

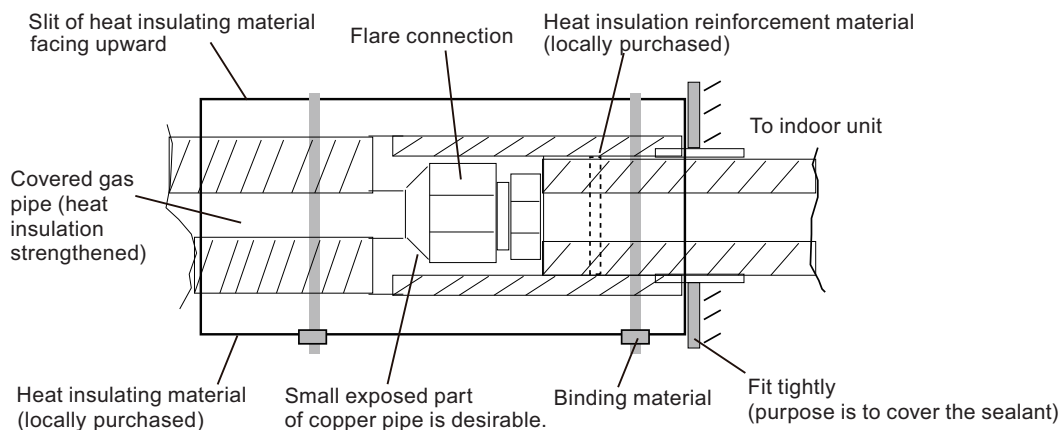

Fig. B

Condition	Contents	Countermeasures (Reference)
When using an external duct.	When using an external duct to take in new fresh air, etc., condensation may form on the surface of the duct due to the effect of the outside air temperature and the humidity inside the ceiling.	Always perform heat insulation processing. (Heat insulating material: Glass wool 25-mm [1-in] thick or more.)
When the remote controller installation site is bad.	If the cold or warm air blown out from the air conditioner directly contacts the thermostat section of the remote controller, the outlet temperature of the air conditioner may be sensed and room temperature control will be different from the room temperature, and "not cooled" or "not heated" or other trouble may occur. In addition, there is the possibility that the same kind of trouble may also occur when the remote controller is effected by direct sunlight.	<ol style="list-style-type: none"> 1. Install the remote controller where it will not be directly exposed to the cold or hot air. 2. Install the remote controller where it will not be directly exposed to sunlight or strong lighting.
When installation environment is quiet.	When the wall mounted type was installed in a bedroom, living room, or other quiet place, the sound of the refrigerant flow may be sensed as noise and must be taken into account.	<ol style="list-style-type: none"> 1. Plan installation of a model with external expansion valve. 2. Plan installation of a branch box farther from indoor unit. 3. Plan installation using another air conditioner.
When installing duct type in ceiling chamber system.	In the case of the ceiling chamber system (duct is not installed at indoor unit inlet side and room air is sucked into the indoor unit through the inside of the ceiling), the thermistor inside the indoor unit may not correctly detect the room temperature. <ul style="list-style-type: none"> • Heating operation: Room is not heated because the indoor unit is easily turned off by the thermostat. • Cooling operation: Room is too cold because the indoor unit is difficult to turn off by the thermostat. 	Replace the indoor unit thermistor with optional Remote sensor unit, and install the sensor where the room temperature can be correctly detected.
When the outlet air is sucked in at duct type.	Cooling operation does not cool the room and heating operation does not heat the room because the short circuited indoor unit is not turned on by the thermostat.	<ol style="list-style-type: none"> 1. Reconsider the ventilation port construction. 2. Replace the indoor unit thermistor with optional Remote sensor unit, and install the sensor where the room temperature can be correctly detected.
When using the wireless remote controller.	Signals may not be received when using it in a room illuminated by an inverter fluorescent lamp.	Turn on the fluorescent lamp and check if the indoor unit receives the signals from the remote controller. If the indoor unit does not receive the signals, consult an authorized service personnel.
When installing the inverter type.	It may generate noise in TV sets, stereos and PCs.	The inverter type should be installed at a sufficient distance from these equipments.

Part 2. OUTDOOR UNIT (5 ROOMS TYPE)

**MULTI TYPE:
AOYG36LBLA5**

1. Specifications

OUTDOOR UNIT
AOYG36LBLA5

OUTDOOR UNIT
AOYG36LBLA5

Type			Inverter heat pump	
Model name			AOYG36LBLA5	
Power supply			230 V ~ 50 Hz	
Available voltage range			198—264 V	
Standard combination of indoor unit			Wall mounted ASYG07LMCA × 4 ASYG09LMCA × 1	
Capacity	Cooling	Rated	kW	10.0
			Btu/h	34,100
		Min.—Max.	kW	3.5—12.5
			Btu/h	11,900—42,700
	Heating	Rated	kW	12.0
			Btu/h	41,000
Min.—Max.		kW	3.5—14.0	
		Btu/h	11,900—47,800	
Input power	Cooling	Rated	kW	2.44
		Max.		3.88
	Heating	Rated		2.79
		Max.		3.82
Current	Cooling	Rated	A	10.6
		Max.		20.6
	Heating	Rated		12.3
		Max.		20.6
EER	Cooling	kW/kW		4.10
COP	Heating			4.30
Starting current			A	12.3
Maximum operating current *1			A	20.6
Fan	Airflow rate	Cooling	m ³ /h	4,200
		Heating		
	Type × Q'ty	Propeller × 1		
	Motor output	W	111	
Sound pressure level*2		Cooling	dB (A)	53
		Heating		55
Heat exchanger type		Dimensions (H × W × D)	mm	966 × 922 × 55
		Fin pitch		1.45
		Rows × Stages	3 × 46	
		Pipe type	Copper	
		Fin type	Type (Material)	Corrugate (Aluminum)
		Surface treatment	Corrosion resistance (Blue fin)	
Compressor	Type × Q'ty	DC twin rotary × 1		
	Motor output	W	2,100	
Refrigerant	Type (Global warming potential)	R410A (2088)		
	Charge	g	4,000	
Refrigerant oil	Type	RB68		
	Amount	cm ³	1,150	
Enclosure	Material	Steel sheet		
	Color	Beige (Approximate color of Munsell 10YR 7.5/1.0 NN)		
Dimensions (H × W × D)	Net	mm	998 × 970 × 370	
	Gross		1,162 × 1,150 × 478	
Weight	Net	kg	94	
	Gross		104	
Connection pipe	Size	Liquid	mm	∅ 6.35 (∅ 1/4) × 5
		Gas		∅ 9.52 (∅ 3/8) × 3 + ∅ 12.70 (∅ 1/2) × 2
	Method		Flare	
	Pre-charge length (Total)		50	
	Maximum length (Total)		80	
	Maximum length (Each)		25	
	Minimum length (Total)		15	
	Minimum length (Each)		5	
	Maximum height difference between outdoor unit and each indoor units.		15	
	Maximum height difference between indoor units.		10	
Operation range	Cooling	°C	-10 to 46	
	Heating		-15 to 24	

NOTES:

- Specifications are based on the following conditions:
 - Power source of specifications: 230 V
 - Pipe length: 5 m, Height difference: 0 m (Outdoor unit—Indoor unit)
 - Cooling: Indoor temperature of 27 °CDB/19 °CWB, and outdoor temperature of 35 °CDB/24 °CWB.
 - Heating: Indoor temperature of 20 °CDB/15 °CWB, and outdoor temperature of 7 °CDB/6 °CWB.
- *1: Maximum operating current is the total current of the indoor unit and the outdoor unit.
- *2: Sound pressure level
 - Measured values in manufacturer's anechoic chamber.
 - Because of the surrounding sound environment, the sound levels measured in actual installation conditions might be higher than the specified values here.
- *3: Connect to connection valve by the adapter.
- For other combination, refer to the combination table.
- The protective function might work when using it outside the operation range.

Product fiche				
Model name			AOYG36LBLA5	
Energy efficiency class	Cooling		A++	
	Heating (average)		A+	
Pdesign	Cooling		kW	10.0
	Heating			9.0
SEER	Cooling		kWh/kWh	7.00
SCOP	Heating			4.40
Annual energy consumption	QCE		kWh/a	500
	QHE (average)			2,859
Sound power level	Cooling	High	dB (A)	67
	Heating			68

2. Dimensions

2-1. Model: AOYG36LBLA5

OUTDOOR UNIT
AOYG36LBLA5

OUTDOOR UNIT
AOYG36LBLA5

Unit: mm

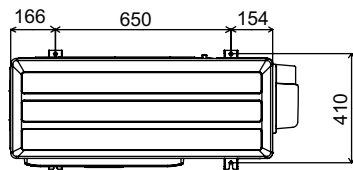

Top view

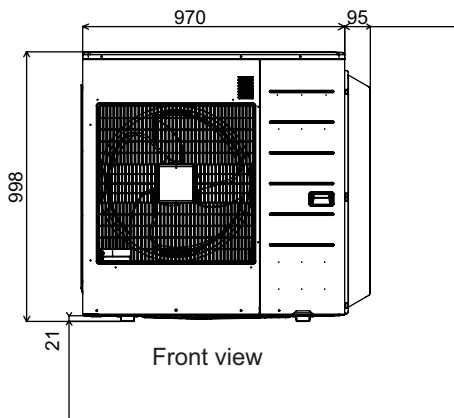
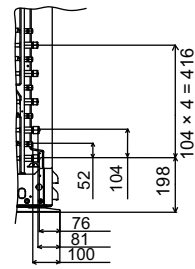

Front view

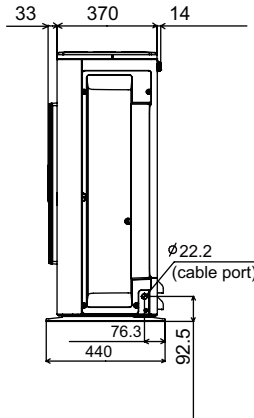

Side view

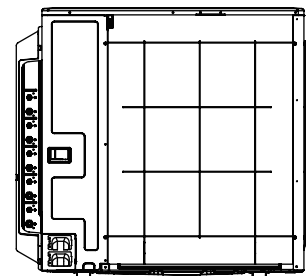

Rear view

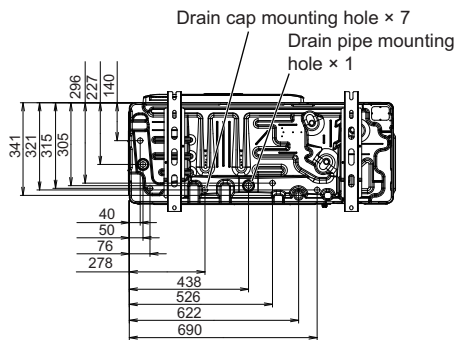

Bottom view

3. Installation space

3-1. Model: AOYG36LBLA5

■ Space requirement

Provide sufficient installation space for product safety.

● Single outdoor unit installation

- When the upper space is open:

Unit: mm

When there are obstacles at the rear only.

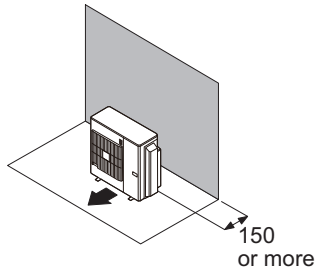

When there are obstacles at the rear and sides.

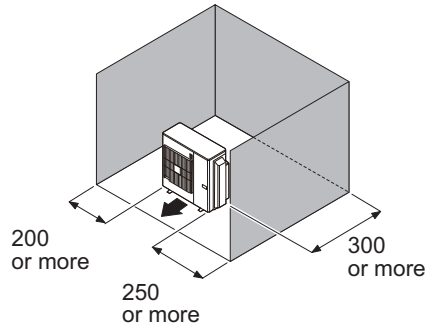

When there are obstacles at the front only.

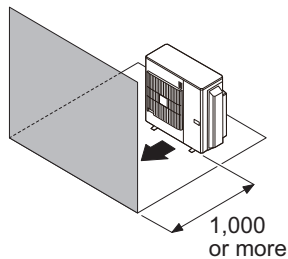

When there are obstacles at the front and rear.

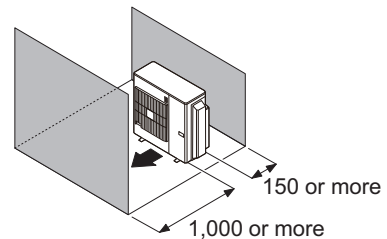

- When there is an obstruction in the upper space:

Unit: mm

When there are obstacles at the rear and above.

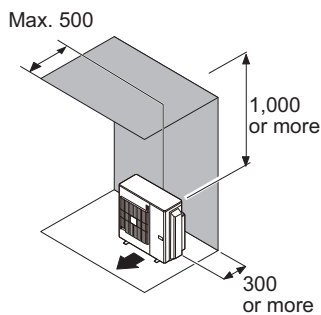

When there are obstacles at the rear, sides, and above.

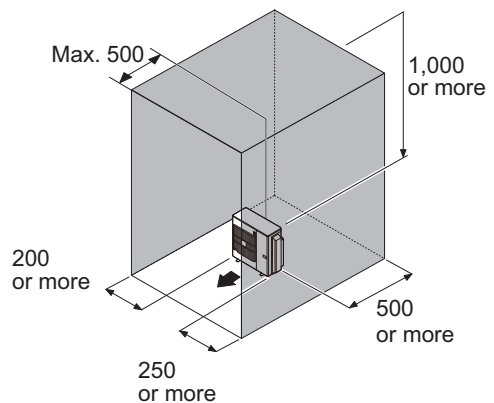

● Multiple outdoor unit installation

- When the upper space is open:

Unit: mm

When there are obstacles at the rear only.

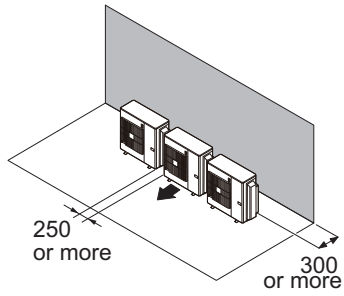

When there are obstacles at the front only.

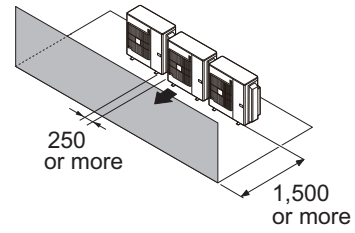

When there are obstacles at the front and rear.

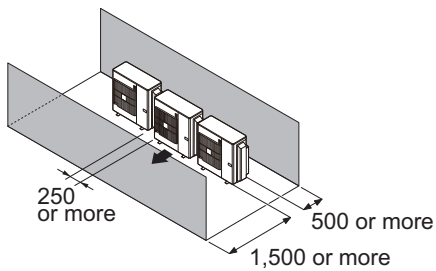

- When there is an obstruction in the upper space:

Unit: mm

When there are obstacles at the rear and above.

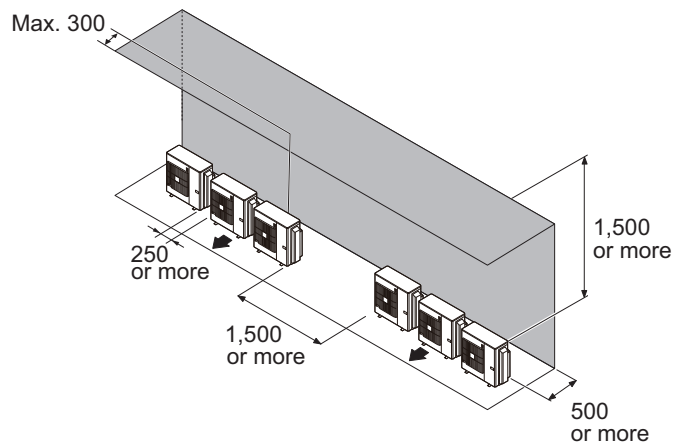

● Outdoor unit installation in multi-row

Unit: mm

Single parallel unit arrangement

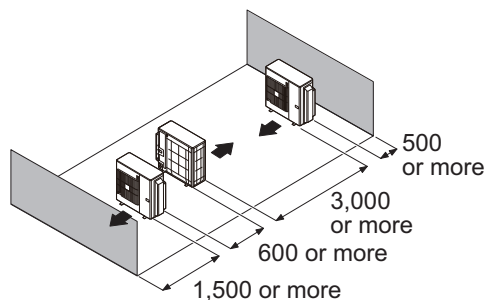

Multiple parallel unit arrangement

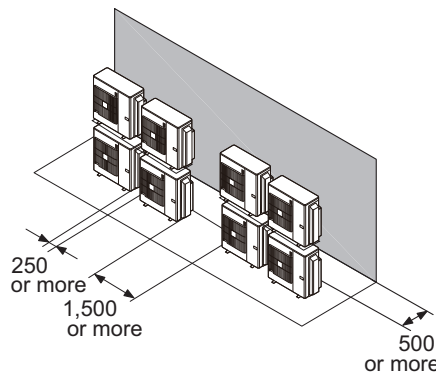
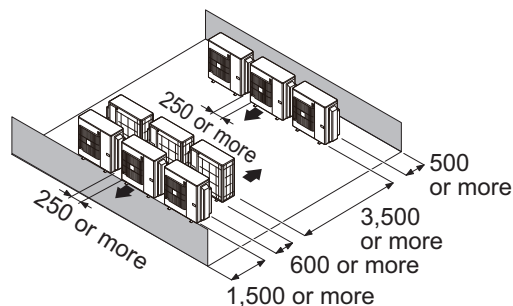

NOTES:

- If the space is larger than stated above, the condition will be the same as when there is no obstacle.
- Height above the floor level should be 50 mm or more.
- When installing the outdoor unit, be sure to open the front and left side to obtain better operation efficiency.

⚠ CAUTION

- Do not install the outdoor unit in two-stage where the drain water could freeze. Otherwise the drainage from the upper unit may form ice and cause a malfunction of the lower unit.
- When the outdoor temperature is 0 °C or less, do not use the accessory drain pipe and drain cap. If the drain pipe and drain cap are used, the drain water in the pipe may freeze in extremely cold climate. (For reverse cycle model only.)
- In area with heavy snowfall, if the inlet and outlet of the outdoor unit is blocked with snow, it might become difficult to get warm, and it is likely to cause product malfunction. Construct a canopy and a pedestal, or place the unit on a high stand that is locally installed.

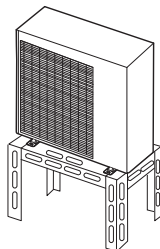

4. Refrigerant circuit

4-1. Model: AOYG36LBLA5

OUTDOOR UNIT
AOYG36LBLA5

OUTDOOR UNIT
AOYG36LBLA5

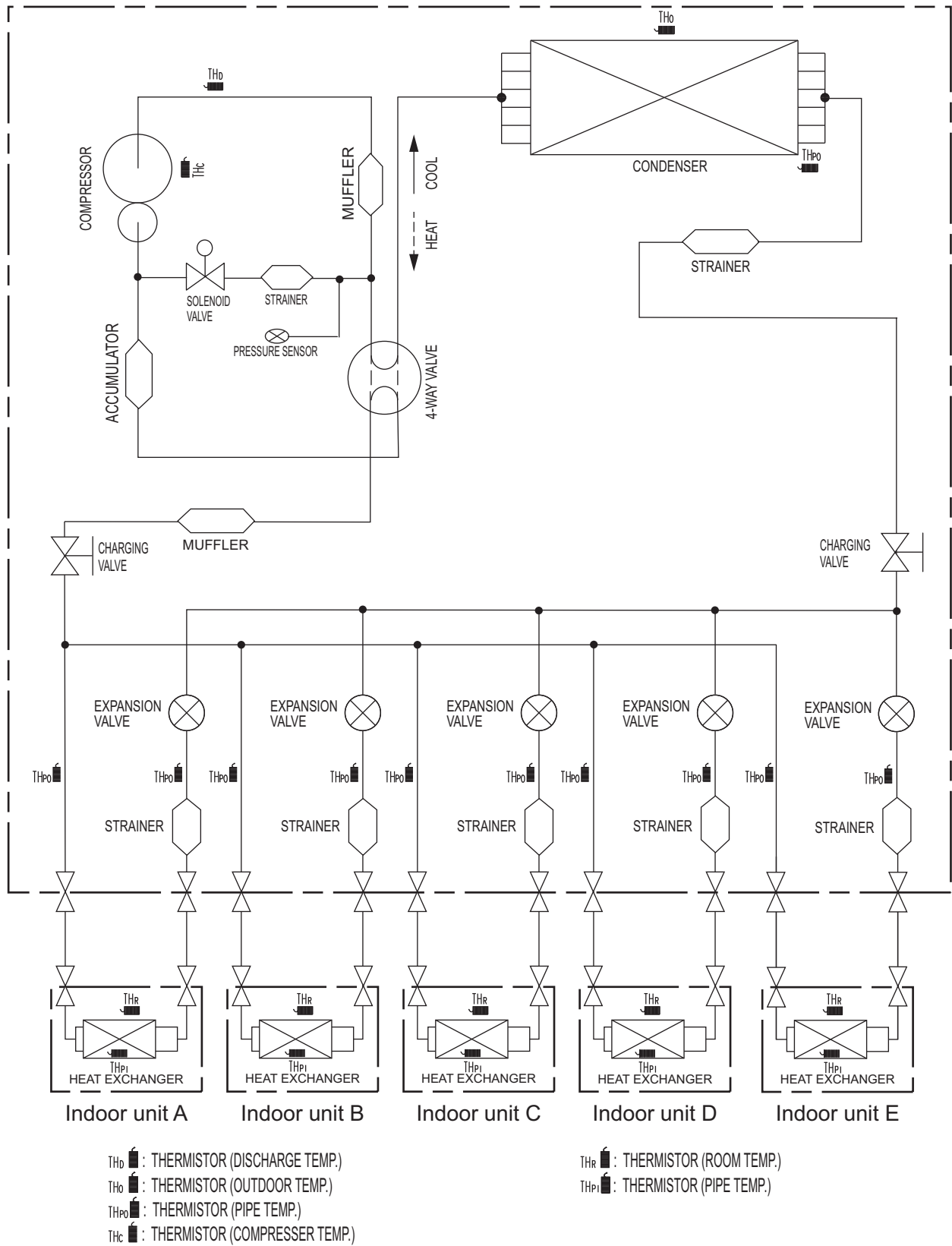

5. Wiring diagram

5-1. Model: AOYG36LBLA5

OUTDOOR UNIT
AOYG36LBLA5

OUTDOOR UNIT
AOYG36LBLA5

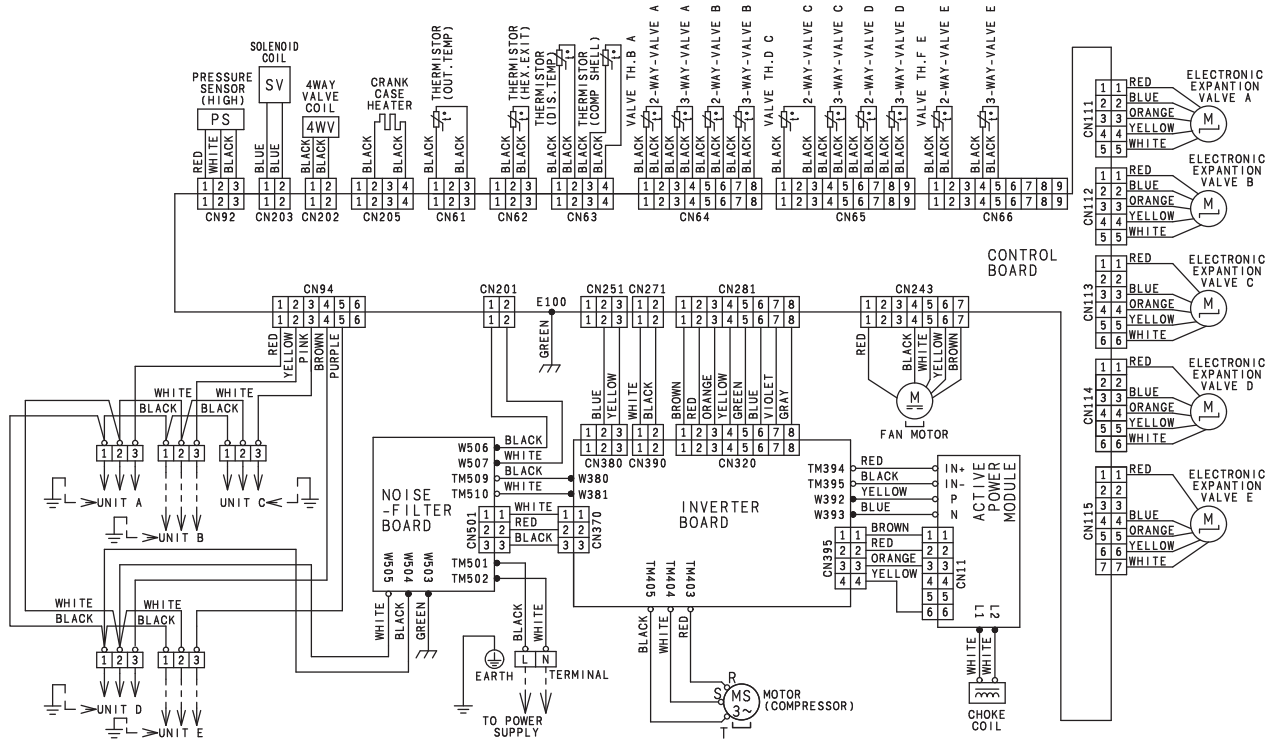

NOTES:

- 7: 7,000 Btu/h, 9: 9,000 Btu/h, 12: 12,000 Btu/h, 14: 14,000 Btu/h, 18: 18,000 Btu/h, 24: 24,000 Btu/h
- Values mentioned in the table are based on the following conditions:
 - Power source of specifications: 230 V
 - Pipe length: 5 m, Height difference: 0 m (Outdoor unit—Indoor unit)
- 2 or more indoor units should be connected.
- The total ability of connected a indoor unit is from 27,000 Btu up to 54,000 Btu.

OUTDOOR UNIT
AOYG36LBA5

OUTDOOR UNIT
AOYG36LBA5

Indoor unit connect- ing capacity	Outdoor temperature	Indoor temperature											
		18.0 °CDB		21.0 °CDB		23.0 °CDB		27.0 °CDB		29.0 °CDB		32.0 °CDB	
		12.0 °CWB		15.0 °CWB		16.0 °CWB		19.0 °CWB		21.0 °CWB		23.0 °CWB	
kBtu/h	°CDB	TC	IP	TC	IP	TC	IP	TC	IP	TC	IP	TC	IP
27	-10.0	7.56	1.01	8.54	1.03	9.01	1.03	9.64	1.05	10.31	1.06	10.63	1.06
	-5.0	7.56	1.00	8.54	1.02	9.01	1.03	9.64	1.04	10.31	1.05	10.63	1.06
	0.0	7.56	1.00	8.54	1.02	9.01	1.02	9.64	1.03	10.31	1.05	10.63	1.05
	5.0	7.56	1.11	8.54	1.13	9.01	1.14	9.64	1.15	10.31	1.17	10.63	1.17
	10.0	7.56	1.23	8.54	1.25	9.01	1.26	9.64	1.27	10.31	1.29	10.63	1.29
	15.0	7.56	1.69	8.54	1.72	9.01	1.73	9.64	1.75	10.31	1.77	10.63	1.78
	20.0	7.56	2.15	8.54	2.19	9.01	2.20	9.64	2.23	10.31	2.25	10.63	2.27
	25.0	7.56	2.37	8.54	2.41	9.01	2.43	9.64	2.46	10.31	2.48	10.63	2.50
	30.0	7.56	2.59	8.54	2.63	9.01	2.65	9.64	2.68	10.31	2.71	10.63	2.73
	35.0	7.56	2.76	8.54	2.81	9.01	2.83	9.64	2.86	10.31	2.90	10.63	2.91
	40.0	7.15	2.90	8.08	2.95	8.52	2.97	9.12	3.01	9.75	3.04	10.05	3.06
46.0	6.75	3.04	7.62	3.09	8.04	3.12	8.61	3.15	9.20	3.19	9.48	3.20	

NOTES:

- TC: Total Capacity (kW), IP: Input Power (kW)
- Values mentioned in the table are based on the following conditions:
 - Power source of specifications: 230 V
 - Pipe length: 5 m, Height difference: 0 m (Outdoor unit—Indoor unit)
- 2 or more indoor units should be connected.
- The total ability of connected a indoor unit is from 27,000 Btu up to 54,000 Btu.
- Input in the table are calculated based on the maximum indoor unit input combinations.

■ Compact cassette type

MODEL: AUYG07LVLA

Outdoor temperature	Indoor temperature (°CDB / °CWB)											
	18.0 / 12.0		21.0 / 15.0		23.0 / 16.0		27.0 / 19.0		29.0 / 21.0		32.0 / 23.0	
(°CDB)	TC	SHC	TC	SHC	TC	SHC	TC	SHC	TC	SHC	TC	SHC
-10.0	1.64	1.09	1.97	1.33	2.22	1.51	2.51	1.96	2.68	2.14	2.77	2.45
-5.0	1.64	1.09	1.97	1.33	2.22	1.51	2.51	1.96	2.68	2.14	2.77	2.45
0.0	1.64	1.09	1.97	1.33	2.22	1.51	2.51	1.96	2.68	2.14	2.77	2.45
5.0	1.64	1.09	1.97	1.33	2.22	1.51	2.51	1.96	2.68	2.14	2.77	2.45
10.0	1.64	1.09	1.97	1.33	2.22	1.51	2.51	1.96	2.68	2.14	2.77	2.45
15.0	1.64	1.09	1.97	1.33	2.22	1.51	2.51	1.96	2.68	2.14	2.77	2.45
20.0	1.64	1.09	1.97	1.33	2.22	1.51	2.51	1.96	2.68	2.14	2.77	2.45
25.0	1.64	1.09	1.97	1.33	2.22	1.51	2.51	1.96	2.68	2.14	2.77	2.45
30.0	1.64	1.09	1.97	1.33	2.22	1.51	2.51	1.96	2.68	2.14	2.77	2.45
35.0	1.64	1.09	1.97	1.33	2.22	1.51	2.51	1.96	2.68	2.14	2.77	2.45
40.0	1.55	0.97	1.86	1.19	2.10	1.36	2.37	1.75	2.54	1.92	2.62	2.20
46.0	1.46	0.87	1.76	1.06	1.98	1.21	2.24	1.56	2.39	1.71	2.47	1.95

OUTDOOR UNIT
AOYG36LBA5OUTDOOR UNIT
AOYG36LBA5

MODEL: AUYG09LVLA

Outdoor temperature	Indoor temperature (°CDB / °CWB)											
	18.0 / 12.0		21.0 / 15.0		23.0 / 16.0		27.0 / 19.0		29.0 / 21.0		32.0 / 23.0	
(°CDB)	TC	SHC	TC	SHC	TC	SHC	TC	SHC	TC	SHC	TC	SHC
-10.0	2.10	1.38	2.52	1.68	2.85	1.92	3.22	2.48	3.44	2.71	3.55	3.11
-5.0	2.10	1.38	2.52	1.68	2.85	1.92	3.22	2.48	3.44	2.71	3.55	3.11
0.0	2.10	1.38	2.52	1.68	2.85	1.92	3.22	2.48	3.44	2.71	3.55	3.11
5.0	2.10	1.38	2.52	1.68	2.85	1.92	3.22	2.48	3.44	2.71	3.55	3.11
10.0	2.10	1.38	2.52	1.68	2.85	1.92	3.22	2.48	3.44	2.71	3.55	3.11
15.0	2.10	1.38	2.52	1.68	2.85	1.92	3.22	2.48	3.44	2.71	3.55	3.11
20.0	2.10	1.38	2.52	1.68	2.85	1.92	3.22	2.48	3.44	2.71	3.55	3.11
25.0	2.10	1.38	2.52	1.68	2.85	1.92	3.22	2.48	3.44	2.71	3.55	3.11
30.0	2.10	1.38	2.52	1.68	2.85	1.92	3.22	2.48	3.44	2.71	3.55	3.11
35.0	2.10	1.38	2.52	1.68	2.85	1.92	3.22	2.48	3.44	2.71	3.55	3.11
40.0	1.99	1.23	2.39	1.51	2.70	1.72	3.05	2.22	3.26	2.43	3.36	2.78
46.0	1.87	1.10	2.25	1.34	2.55	1.53	2.87	1.97	3.07	2.16	3.17	2.47

MODEL: AUYG12LVLB

Outdoor temperature	Indoor temperature (°CDB / °CWB)											
	18.0 / 12.0		21.0 / 15.0		23.0 / 16.0		27.0 / 19.0		29.0 / 21.0		32.0 / 23.0	
(°CDB)	TC	SHC	TC	SHC	TC	SHC	TC	SHC	TC	SHC	TC	SHC
-10.0	2.80	1.82	3.37	2.22	3.81	2.53	4.30	3.27	4.60	3.57	4.74	4.10
-5.0	2.80	1.82	3.37	2.22	3.81	2.53	4.30	3.27	4.60	3.57	4.74	4.10
0.0	2.80	1.82	3.37	2.22	3.81	2.53	4.30	3.27	4.60	3.57	4.74	4.10
5.0	2.80	1.82	3.37	2.22	3.81	2.53	4.30	3.27	4.60	3.57	4.74	4.10
10.0	2.80	1.82	3.37	2.22	3.81	2.53	4.30	3.27	4.60	3.57	4.74	4.10
15.0	2.80	1.82	3.37	2.22	3.81	2.53	4.30	3.27	4.60	3.57	4.74	4.10
20.0	2.80	1.82	3.37	2.22	3.81	2.53	4.30	3.27	4.60	3.57	4.74	4.10
25.0	2.80	1.82	3.37	2.22	3.81	2.53	4.30	3.27	4.60	3.57	4.74	4.10
30.0	2.80	1.82	3.37	2.22	3.81	2.53	4.30	3.27	4.60	3.57	4.74	4.10
35.0	2.80	1.82	3.37	2.22	3.81	2.53	4.30	3.27	4.60	3.57	4.74	4.10
40.0	2.65	1.63	3.19	1.98	3.60	2.26	4.07	2.93	4.35	3.20	4.48	3.67
46.0	2.50	1.45	3.01	1.76	3.40	2.01	3.84	2.60	4.10	2.85	4.23	3.26

MODEL: AUYG14LVLB

Outdoor temperature	Indoor temperature (°CDB / °CWB)											
	18.0 / 12.0		21.0 / 15.0		23.0 / 16.0		27.0 / 19.0		29.0 / 21.0		32.0 / 23.0	
(°CDB)	TC	SHC	TC	SHC	TC	SHC	TC	SHC	TC	SHC	TC	SHC
-10.0	3.26	2.01	3.93	2.45	4.44	2.79	5.01	3.61	5.36	3.95	5.52	4.52
-5.0	3.26	2.01	3.93	2.45	4.44	2.79	5.01	3.61	5.36	3.95	5.52	4.52
0.0	3.26	2.01	3.93	2.45	4.44	2.79	5.01	3.61	5.36	3.95	5.52	4.52
5.0	3.26	2.01	3.93	2.45	4.44	2.79	5.01	3.61	5.36	3.95	5.52	4.52
10.0	3.26	2.01	3.93	2.45	4.44	2.79	5.01	3.61	5.36	3.95	5.52	4.52
15.0	3.26	2.01	3.93	2.45	4.44	2.79	5.01	3.61	5.36	3.95	5.52	4.52
20.0	3.26	2.01	3.93	2.45	4.44	2.79	5.01	3.61	5.36	3.95	5.52	4.52
25.0	3.26	2.01	3.93	2.45	4.44	2.79	5.01	3.61	5.36	3.95	5.52	4.52
30.0	3.26	2.01	3.93	2.45	4.44	2.79	5.01	3.61	5.36	3.95	5.52	4.52
35.0	3.26	2.01	3.93	2.45	4.44	2.79	5.01	3.61	5.36	3.95	5.52	4.52
40.0	3.09	1.80	3.72	2.19	4.20	2.50	4.74	3.23	5.07	3.53	5.22	4.05
46.0	2.91	1.60	3.51	1.95	3.96	2.22	4.47	2.87	4.78	3.14	4.93	3.60

MODEL: AUYG18LVLB

Outdoor temperature (°CDB)	Indoor temperature (°CDB / °CWB)											
	18.0 / 12.0		21.0 / 15.0		23.0 / 16.0		27.0 / 19.0		29.0 / 21.0		32.0 / 23.0	
	TC	SHC	TC	SHC	TC	SHC	TC	SHC	TC	SHC	TC	SHC
-10.0	4.18	2.50	5.03	3.05	5.69	3.47	6.42	4.49	6.86	4.92	7.07	5.63
-5.0	4.18	2.50	5.03	3.05	5.69	3.47	6.42	4.49	6.86	4.92	7.07	5.63
0.0	4.18	2.50	5.03	3.05	5.69	3.47	6.42	4.49	6.86	4.92	7.07	5.63
5.0	4.18	2.50	5.03	3.05	5.69	3.47	6.42	4.49	6.86	4.92	7.07	5.63
10.0	4.18	2.50	5.03	3.05	5.69	3.47	6.42	4.49	6.86	4.92	7.07	5.63
15.0	4.18	2.50	5.03	3.05	5.69	3.47	6.42	4.49	6.86	4.92	7.07	5.63
20.0	4.18	2.50	5.03	3.05	5.69	3.47	6.42	4.49	6.86	4.92	7.07	5.63
25.0	4.18	2.50	5.03	3.05	5.69	3.47	6.42	4.49	6.86	4.92	7.07	5.63
30.0	4.18	2.50	5.03	3.05	5.69	3.47	6.42	4.49	6.86	4.92	7.07	5.63
35.0	4.18	2.50	5.03	3.05	5.69	3.47	6.42	4.49	6.86	4.92	7.07	5.63
40.0	3.96	2.24	4.76	2.73	5.38	3.11	6.07	4.02	6.49	4.40	6.69	5.04
46.0	3.73	1.99	4.49	2.43	5.08	2.77	5.73	3.58	6.12	3.91	6.31	4.48

NOTES:

- TC: Total Capacity (kW), SHC: Sensible Heat Capacity (kW)
- Values mentioned in the table are based on the following conditions:
 - Pipe length: 5 m, Height difference: 0 m (Outdoor unit—Indoor unit)

■ Mini duct type

MODEL: ARYG07LSLAP

Outdoor temperature	Indoor temperature (°CDB / °CWB)											
	18.0 / 12.0		21.0 / 15.0		23.0 / 16.0		27.0 / 19.0		29.0 / 21.0		32.0 / 23.0	
(°CDB)	TC	SHC	TC	SHC	TC	SHC	TC	SHC	TC	SHC	TC	SHC
-10.0	1.64	1.12	1.97	1.36	2.22	1.55	2.51	2.01	2.68	2.20	2.77	2.52
-5.0	1.64	1.12	1.97	1.36	2.22	1.55	2.51	2.01	2.68	2.20	2.77	2.52
0.0	1.64	1.12	1.97	1.36	2.22	1.55	2.51	2.01	2.68	2.20	2.77	2.52
5.0	1.64	1.12	1.97	1.36	2.22	1.55	2.51	2.01	2.68	2.20	2.77	2.52
10.0	1.64	1.12	1.97	1.36	2.22	1.55	2.51	2.01	2.68	2.20	2.77	2.52
15.0	1.64	1.12	1.97	1.36	2.22	1.55	2.51	2.01	2.68	2.20	2.77	2.52
20.0	1.64	1.12	1.97	1.36	2.22	1.55	2.51	2.01	2.68	2.20	2.77	2.52
25.0	1.64	1.12	1.97	1.36	2.22	1.55	2.51	2.01	2.68	2.20	2.77	2.52
30.0	1.64	1.12	1.97	1.36	2.22	1.55	2.51	2.01	2.68	2.20	2.77	2.52
35.0	1.64	1.12	1.97	1.36	2.22	1.55	2.51	2.01	2.68	2.20	2.77	2.52
40.0	1.55	1.00	1.86	1.22	2.10	1.39	2.37	1.80	2.54	1.97	2.62	2.25
46.0	1.46	0.89	1.76	1.08	1.98	1.24	2.24	1.60	2.39	1.75	2.47	2.00

OUTDOOR UNIT
AOYG36LBA5OUTDOOR UNIT
AOYG36LBA5

MODEL: ARYG09LSLAP

Outdoor temperature	Indoor temperature (°CDB / °CWB)											
	18.0 / 12.0		21.0 / 15.0		23.0 / 16.0		27.0 / 19.0		29.0 / 21.0		32.0 / 23.0	
(°CDB)	TC	SHC	TC	SHC	TC	SHC	TC	SHC	TC	SHC	TC	SHC
-10.0	2.10	1.33	2.52	1.62	2.85	1.84	3.22	2.38	3.44	2.61	3.55	2.99
-5.0	2.10	1.33	2.52	1.62	2.85	1.84	3.22	2.38	3.44	2.61	3.55	2.99
0.0	2.10	1.33	2.52	1.62	2.85	1.84	3.22	2.38	3.44	2.61	3.55	2.99
5.0	2.10	1.33	2.52	1.62	2.85	1.84	3.22	2.38	3.44	2.61	3.55	2.99
10.0	2.10	1.33	2.52	1.62	2.85	1.84	3.22	2.38	3.44	2.61	3.55	2.99
15.0	2.10	1.33	2.52	1.62	2.85	1.84	3.22	2.38	3.44	2.61	3.55	2.99
20.0	2.10	1.33	2.52	1.62	2.85	1.84	3.22	2.38	3.44	2.61	3.55	2.99
25.0	2.10	1.33	2.52	1.62	2.85	1.84	3.22	2.38	3.44	2.61	3.55	2.99
30.0	2.10	1.33	2.52	1.62	2.85	1.84	3.22	2.38	3.44	2.61	3.55	2.99
35.0	2.10	1.33	2.52	1.62	2.85	1.84	3.22	2.38	3.44	2.61	3.55	2.99
40.0	1.99	1.19	2.39	1.45	2.70	1.65	3.05	2.13	3.26	2.33	3.36	2.67
46.0	1.87	1.06	2.25	1.29	2.55	1.47	2.87	1.90	3.07	2.08	3.17	2.38

MODEL: ARYG12LSLAP

Outdoor temperature	Indoor temperature (°CDB / °CWB)											
	18.0 / 12.0		21.0 / 15.0		23.0 / 16.0		27.0 / 19.0		29.0 / 21.0		32.0 / 23.0	
(°CDB)	TC	SHC	TC	SHC	TC	SHC	TC	SHC	TC	SHC	TC	SHC
-10.0	2.80	1.77	3.37	2.16	3.81	2.46	4.30	3.18	4.60	3.48	4.74	3.99
-5.0	2.80	1.77	3.37	2.16	3.81	2.46	4.30	3.18	4.60	3.48	4.74	3.99
0.0	2.80	1.77	3.37	2.16	3.81	2.46	4.30	3.18	4.60	3.48	4.74	3.99
5.0	2.80	1.77	3.37	2.16	3.81	2.46	4.30	3.18	4.60	3.48	4.74	3.99
10.0	2.80	1.77	3.37	2.16	3.81	2.46	4.30	3.18	4.60	3.48	4.74	3.99
15.0	2.80	1.77	3.37	2.16	3.81	2.46	4.30	3.18	4.60	3.48	4.74	3.99
20.0	2.80	1.77	3.37	2.16	3.81	2.46	4.30	3.18	4.60	3.48	4.74	3.99
25.0	2.80	1.77	3.37	2.16	3.81	2.46	4.30	3.18	4.60	3.48	4.74	3.99
30.0	2.80	1.77	3.37	2.16	3.81	2.46	4.30	3.18	4.60	3.48	4.74	3.99
35.0	2.80	1.77	3.37	2.16	3.81	2.46	4.30	3.18	4.60	3.48	4.74	3.99
40.0	2.65	1.58	3.19	1.93	3.60	2.20	4.07	2.85	4.35	3.12	4.48	3.57
46.0	2.50	1.41	3.01	1.72	3.40	1.96	3.84	2.53	4.10	2.77	4.23	3.18

MODEL: ARYG14LSLAP

Outdoor temperature	Indoor temperature (°CDB / °CWB)											
	18.0 / 12.0		21.0 / 15.0		23.0 / 16.0		27.0 / 19.0		29.0 / 21.0		32.0 / 23.0	
(°CDB)	TC	SHC	TC	SHC	TC	SHC	TC	SHC	TC	SHC	TC	SHC
-10.0	3.26	2.06	3.93	2.51	4.44	2.87	5.01	3.71	5.36	4.05	5.52	4.65
-5.0	3.26	2.06	3.93	2.51	4.44	2.87	5.01	3.71	5.36	4.05	5.52	4.65
0.0	3.26	2.06	3.93	2.51	4.44	2.87	5.01	3.71	5.36	4.05	5.52	4.65
5.0	3.26	2.06	3.93	2.51	4.44	2.87	5.01	3.71	5.36	4.05	5.52	4.65
10.0	3.26	2.06	3.93	2.51	4.44	2.87	5.01	3.71	5.36	4.05	5.52	4.65
15.0	3.26	2.06	3.93	2.51	4.44	2.87	5.01	3.71	5.36	4.05	5.52	4.65
20.0	3.26	2.06	3.93	2.51	4.44	2.87	5.01	3.71	5.36	4.05	5.52	4.65
25.0	3.26	2.06	3.93	2.51	4.44	2.87	5.01	3.71	5.36	4.05	5.52	4.65
30.0	3.26	2.06	3.93	2.51	4.44	2.87	5.01	3.71	5.36	4.05	5.52	4.65
35.0	3.26	2.06	3.93	2.51	4.44	2.87	5.01	3.71	5.36	4.05	5.52	4.65
40.0	3.09	1.85	3.72	2.25	4.20	2.57	4.74	3.32	5.07	3.63	5.22	4.16
46.0	2.91	1.64	3.51	2.00	3.96	2.28	4.47	2.95	4.78	3.23	4.93	3.70

MODEL: ARYG18LSLAP

Outdoor temperature (°CDB)	Indoor temperature (°CDB / °CWB)											
	18.0 / 12.0		21.0 / 15.0		23.0 / 16.0		27.0 / 19.0		29.0 / 21.0		32.0 / 23.0	
	TC	SHC	TC	SHC	TC	SHC	TC	SHC	TC	SHC	TC	SHC
-10.0	4.18	2.57	5.03	3.13	5.69	3.57	6.42	4.62	6.86	5.06	7.07	5.79
-5.0	4.18	2.57	5.03	3.13	5.69	3.57	6.42	4.62	6.86	5.06	7.07	5.79
0.0	4.18	2.57	5.03	3.13	5.69	3.57	6.42	4.62	6.86	5.06	7.07	5.79
5.0	4.18	2.57	5.03	3.13	5.69	3.57	6.42	4.62	6.86	5.06	7.07	5.79
10.0	4.18	2.57	5.03	3.13	5.69	3.57	6.42	4.62	6.86	5.06	7.07	5.79
15.0	4.18	2.57	5.03	3.13	5.69	3.57	6.42	4.62	6.86	5.06	7.07	5.79
20.0	4.18	2.57	5.03	3.13	5.69	3.57	6.42	4.62	6.86	5.06	7.07	5.79
25.0	4.18	2.57	5.03	3.13	5.69	3.57	6.42	4.62	6.86	5.06	7.07	5.79
30.0	4.18	2.57	5.03	3.13	5.69	3.57	6.42	4.62	6.86	5.06	7.07	5.79
35.0	4.18	2.57	5.03	3.13	5.69	3.57	6.42	4.62	6.86	5.06	7.07	5.79
40.0	3.96	2.30	4.76	2.81	5.38	3.20	6.07	4.14	6.49	4.53	6.69	5.19
46.0	3.73	2.05	4.49	2.50	5.08	2.85	5.73	3.68	6.12	4.03	6.31	4.61

NOTES:

- TC: Total Capacity (kW), SHC: Sensible Heat Capacity (kW)
- Values mentioned in the table are based on the following conditions:
 - Pipe length: 5 m, Height difference: 0 m [Outdoor unit—Indoor unit]

■ Slim duct type

MODEL: ARYG07LLTA

Outdoor temperature	Indoor temperature (°CDB / °CWB)											
	18.0 / 12.0		21.0 / 15.0		23.0 / 16.0		27.0 / 19.0		29.0 / 21.0		32.0 / 23.0	
(°CDB)	TC	SHC	TC	SHC	TC	SHC	TC	SHC	TC	SHC	TC	SHC
-10.0	1.64	1.12	1.97	1.36	2.22	1.55	2.51	2.01	2.68	2.20	2.77	2.52
-5.0	1.64	1.12	1.97	1.36	2.22	1.55	2.51	2.01	2.68	2.20	2.77	2.52
0.0	1.64	1.12	1.97	1.36	2.22	1.55	2.51	2.01	2.68	2.20	2.77	2.52
5.0	1.64	1.12	1.97	1.36	2.22	1.55	2.51	2.01	2.68	2.20	2.77	2.52
10.0	1.64	1.12	1.97	1.36	2.22	1.55	2.51	2.01	2.68	2.20	2.77	2.52
15.0	1.64	1.12	1.97	1.36	2.22	1.55	2.51	2.01	2.68	2.20	2.77	2.52
20.0	1.64	1.12	1.97	1.36	2.22	1.55	2.51	2.01	2.68	2.20	2.77	2.52
25.0	1.64	1.12	1.97	1.36	2.22	1.55	2.51	2.01	2.68	2.20	2.77	2.52
30.0	1.64	1.12	1.97	1.36	2.22	1.55	2.51	2.01	2.68	2.20	2.77	2.52
35.0	1.64	1.12	1.97	1.36	2.22	1.55	2.51	2.01	2.68	2.20	2.77	2.52
40.0	1.55	1.00	1.86	1.22	2.10	1.39	2.37	1.80	2.54	1.97	2.62	2.25
46.0	1.46	0.89	1.76	1.08	1.98	1.24	2.24	1.60	2.39	1.75	2.47	2.00

MODEL: ARYG09LLTA

Outdoor temperature	Indoor temperature (°CDB / °CWB)											
	18.0 / 12.0		21.0 / 15.0		23.0 / 16.0		27.0 / 19.0		29.0 / 21.0		32.0 / 23.0	
(°CDB)	TC	SHC	TC	SHC	TC	SHC	TC	SHC	TC	SHC	TC	SHC
-10.0	2.10	1.33	2.52	1.62	2.85	1.84	3.22	2.38	3.44	2.61	3.55	2.99
-5.0	2.10	1.33	2.52	1.62	2.85	1.84	3.22	2.38	3.44	2.61	3.55	2.99
0.0	2.10	1.33	2.52	1.62	2.85	1.84	3.22	2.38	3.44	2.61	3.55	2.99
5.0	2.10	1.33	2.52	1.62	2.85	1.84	3.22	2.38	3.44	2.61	3.55	2.99
10.0	2.10	1.33	2.52	1.62	2.85	1.84	3.22	2.38	3.44	2.61	3.55	2.99
15.0	2.10	1.33	2.52	1.62	2.85	1.84	3.22	2.38	3.44	2.61	3.55	2.99
20.0	2.10	1.33	2.52	1.62	2.85	1.84	3.22	2.38	3.44	2.61	3.55	2.99
25.0	2.10	1.33	2.52	1.62	2.85	1.84	3.22	2.38	3.44	2.61	3.55	2.99
30.0	2.10	1.33	2.52	1.62	2.85	1.84	3.22	2.38	3.44	2.61	3.55	2.99
35.0	2.10	1.33	2.52	1.62	2.85	1.84	3.22	2.38	3.44	2.61	3.55	2.99
40.0	1.99	1.19	2.39	1.45	2.70	1.65	3.05	2.13	3.26	2.33	3.36	2.67
46.0	1.87	1.06	2.25	1.29	2.55	1.47	2.87	1.90	3.07	2.08	3.17	2.38

MODEL: ARYG12LLTB

Outdoor temperature	Indoor temperature (°CDB / °CWB)											
	18.0 / 12.0		21.0 / 15.0		23.0 / 16.0		27.0 / 19.0		29.0 / 21.0		32.0 / 23.0	
(°CDB)	TC	SHC	TC	SHC	TC	SHC	TC	SHC	TC	SHC	TC	SHC
-10.0	2.80	1.77	3.37	2.16	3.81	2.46	4.30	3.18	4.60	3.48	4.74	3.99
-5.0	2.80	1.77	3.37	2.16	3.81	2.46	4.30	3.18	4.60	3.48	4.74	3.99
0.0	2.80	1.77	3.37	2.16	3.81	2.46	4.30	3.18	4.60	3.48	4.74	3.99
5.0	2.80	1.77	3.37	2.16	3.81	2.46	4.30	3.18	4.60	3.48	4.74	3.99
10.0	2.80	1.77	3.37	2.16	3.81	2.46	4.30	3.18	4.60	3.48	4.74	3.99
15.0	2.80	1.77	3.37	2.16	3.81	2.46	4.30	3.18	4.60	3.48	4.74	3.99
20.0	2.80	1.77	3.37	2.16	3.81	2.46	4.30	3.18	4.60	3.48	4.74	3.99
25.0	2.80	1.77	3.37	2.16	3.81	2.46	4.30	3.18	4.60	3.48	4.74	3.99
30.0	2.80	1.77	3.37	2.16	3.81	2.46	4.30	3.18	4.60	3.48	4.74	3.99
35.0	2.80	1.77	3.37	2.16	3.81	2.46	4.30	3.18	4.60	3.48	4.74	3.99
40.0	2.65	1.58	3.19	1.93	3.60	2.20	4.07	2.85	4.35	3.12	4.48	3.57
46.0	2.50	1.41	3.01	1.72	3.40	1.96	3.84	2.53	4.10	2.77	4.23	3.18

MODEL: ARYG14LLTB

Outdoor temperature	Indoor temperature (°CDB / °CWB)											
	18.0 / 12.0		21.0 / 15.0		23.0 / 16.0		27.0 / 19.0		29.0 / 21.0		32.0 / 23.0	
(°CDB)	TC	SHC	TC	SHC	TC	SHC	TC	SHC	TC	SHC	TC	SHC
-10.0	3.26	2.06	3.93	2.51	4.44	2.87	5.01	3.71	5.36	4.05	5.52	4.65
-5.0	3.26	2.06	3.93	2.51	4.44	2.87	5.01	3.71	5.36	4.05	5.52	4.65
0.0	3.26	2.06	3.93	2.51	4.44	2.87	5.01	3.71	5.36	4.05	5.52	4.65
5.0	3.26	2.06	3.93	2.51	4.44	2.87	5.01	3.71	5.36	4.05	5.52	4.65
10.0	3.26	2.06	3.93	2.51	4.44	2.87	5.01	3.71	5.36	4.05	5.52	4.65
15.0	3.26	2.06	3.93	2.51	4.44	2.87	5.01	3.71	5.36	4.05	5.52	4.65
20.0	3.26	2.06	3.93	2.51	4.44	2.87	5.01	3.71	5.36	4.05	5.52	4.65
25.0	3.26	2.06	3.93	2.51	4.44	2.87	5.01	3.71	5.36	4.05	5.52	4.65
30.0	3.26	2.06	3.93	2.51	4.44	2.87	5.01	3.71	5.36	4.05	5.52	4.65
35.0	3.26	2.06	3.93	2.51	4.44	2.87	5.01	3.71	5.36	4.05	5.52	4.65
40.0	3.09	1.85	3.72	2.25	4.20	2.57	4.74	3.32	5.07	3.63	5.22	4.16
46.0	2.91	1.64	3.51	2.00	3.96	2.28	4.47	2.95	4.78	3.23	4.93	3.70

MODEL: ARYG18LLTB

Outdoor temperature (°CDB)	Indoor temperature (°CDB / °CWB)											
	18.0 / 12.0		21.0 / 15.0		23.0 / 16.0		27.0 / 19.0		29.0 / 21.0		32.0 / 23.0	
	TC	SHC	TC	SHC	TC	SHC	TC	SHC	TC	SHC	TC	SHC
-10.0	4.18	2.57	5.03	3.13	5.69	3.57	6.42	4.62	6.86	5.06	7.07	5.79
-5.0	4.18	2.57	5.03	3.13	5.69	3.57	6.42	4.62	6.86	5.06	7.07	5.79
0.0	4.18	2.57	5.03	3.13	5.69	3.57	6.42	4.62	6.86	5.06	7.07	5.79
5.0	4.18	2.57	5.03	3.13	5.69	3.57	6.42	4.62	6.86	5.06	7.07	5.79
10.0	4.18	2.57	5.03	3.13	5.69	3.57	6.42	4.62	6.86	5.06	7.07	5.79
15.0	4.18	2.57	5.03	3.13	5.69	3.57	6.42	4.62	6.86	5.06	7.07	5.79
20.0	4.18	2.57	5.03	3.13	5.69	3.57	6.42	4.62	6.86	5.06	7.07	5.79
25.0	4.18	2.57	5.03	3.13	5.69	3.57	6.42	4.62	6.86	5.06	7.07	5.79
30.0	4.18	2.57	5.03	3.13	5.69	3.57	6.42	4.62	6.86	5.06	7.07	5.79
35.0	4.18	2.57	5.03	3.13	5.69	3.57	6.42	4.62	6.86	5.06	7.07	5.79
40.0	3.96	2.30	4.76	2.81	5.38	3.20	6.07	4.14	6.49	4.53	6.69	5.19
46.0	3.73	2.05	4.49	2.50	5.08	2.85	5.73	3.68	6.12	4.03	6.31	4.61

NOTES:

- TC: Total Capacity (kW), SHC: Sensible Heat Capacity (kW)
- Values mentioned in the table are based on the following conditions:
 - Pipe length: 5 m, Height difference: 0 m (Outdoor unit—Indoor unit)

Wall mounted type

MODELS: ASYG07LMCA, ASYG07LMCE, and ASYG07LUCA

Outdoor temperature	Indoor temperature (°CDB / °CWB)											
	18.0 / 12.0		21.0 / 15.0		23.0 / 16.0		27.0 / 19.0		29.0 / 21.0		32.0 / 23.0	
(°CDB)	TC	SHC	TC	SHC	TC	SHC	TC	SHC	TC	SHC	TC	SHC
-10.0	1.64	1.13	1.97	1.38	2.22	1.57	2.51	2.03	2.68	2.22	2.77	2.55
-5.0	1.64	1.13	1.97	1.38	2.22	1.57	2.51	2.03	2.68	2.22	2.77	2.55
0.0	1.64	1.13	1.97	1.38	2.22	1.57	2.51	2.03	2.68	2.22	2.77	2.55
5.0	1.64	1.13	1.97	1.38	2.22	1.57	2.51	2.03	2.68	2.22	2.77	2.55
10.0	1.64	1.13	1.97	1.38	2.22	1.57	2.51	2.03	2.68	2.22	2.77	2.55
15.0	1.64	1.13	1.97	1.38	2.22	1.57	2.51	2.03	2.68	2.22	2.77	2.55
20.0	1.64	1.13	1.97	1.38	2.22	1.57	2.51	2.03	2.68	2.22	2.77	2.55
25.0	1.64	1.13	1.97	1.38	2.22	1.57	2.51	2.03	2.68	2.22	2.77	2.55
30.0	1.64	1.13	1.97	1.38	2.22	1.57	2.51	2.03	2.68	2.22	2.77	2.55
35.0	1.64	1.13	1.97	1.38	2.22	1.57	2.51	2.03	2.68	2.22	2.77	2.55
40.0	1.55	1.01	1.86	1.23	2.10	1.41	2.37	1.82	2.54	1.99	2.62	2.28
46.0	1.46	0.90	1.76	1.10	1.98	1.25	2.24	1.62	2.39	1.77	2.47	2.03

OUTDOOR UNIT
AOYG36LBA5OUTDOOR UNIT
AOYG36LBA5

MODELS: ASYG09LMCA, ASYG09LMCE, and ASYG09LUCA

Outdoor temperature	Indoor temperature (°CDB / °CWB)											
	18.0 / 12.0		21.0 / 15.0		23.0 / 16.0		27.0 / 19.0		29.0 / 21.0		32.0 / 23.0	
(°CDB)	TC	SHC	TC	SHC	TC	SHC	TC	SHC	TC	SHC	TC	SHC
-10.0	2.10	1.45	2.52	1.77	2.85	2.02	3.22	2.61	3.44	2.85	3.55	3.27
-5.0	2.10	1.45	2.52	1.77	2.85	2.02	3.22	2.61	3.44	2.85	3.55	3.27
0.0	2.10	1.45	2.52	1.77	2.85	2.02	3.22	2.61	3.44	2.85	3.55	3.27
5.0	2.10	1.45	2.52	1.77	2.85	2.02	3.22	2.61	3.44	2.85	3.55	3.27
10.0	2.10	1.45	2.52	1.77	2.85	2.02	3.22	2.61	3.44	2.85	3.55	3.27
15.0	2.10	1.45	2.52	1.77	2.85	2.02	3.22	2.61	3.44	2.85	3.55	3.27
20.0	2.10	1.45	2.52	1.77	2.85	2.02	3.22	2.61	3.44	2.85	3.55	3.27
25.0	2.10	1.45	2.52	1.77	2.85	2.02	3.22	2.61	3.44	2.85	3.55	3.27
30.0	2.10	1.45	2.52	1.77	2.85	2.02	3.22	2.61	3.44	2.85	3.55	3.27
35.0	2.10	1.45	2.52	1.77	2.85	2.02	3.22	2.61	3.44	2.85	3.55	3.27
40.0	1.99	1.30	2.39	1.58	2.70	1.81	3.05	2.34	3.26	2.55	3.36	2.93
46.0	1.87	1.16	2.25	1.41	2.55	1.61	2.87	2.08	3.07	2.27	3.17	2.60

MODELS: ASYG12LMCA, ASYG12LMCE, and ASYG12LUCA

Outdoor temperature	Indoor temperature (°CDB / °CWB)											
	18.0 / 12.0		21.0 / 15.0		23.0 / 16.0		27.0 / 19.0		29.0 / 21.0		32.0 / 23.0	
(°CDB)	TC	SHC	TC	SHC	TC	SHC	TC	SHC	TC	SHC	TC	SHC
-10.0	2.80	1.82	3.37	2.22	3.81	2.53	4.30	3.27	4.60	3.57	4.74	4.10
-5.0	2.80	1.82	3.37	2.22	3.81	2.53	4.30	3.27	4.60	3.57	4.74	4.10
0.0	2.80	1.82	3.37	2.22	3.81	2.53	4.30	3.27	4.60	3.57	4.74	4.10
5.0	2.80	1.82	3.37	2.22	3.81	2.53	4.30	3.27	4.60	3.57	4.74	4.10
10.0	2.80	1.82	3.37	2.22	3.81	2.53	4.30	3.27	4.60	3.57	4.74	4.10
15.0	2.80	1.82	3.37	2.22	3.81	2.53	4.30	3.27	4.60	3.57	4.74	4.10
20.0	2.80	1.82	3.37	2.22	3.81	2.53	4.30	3.27	4.60	3.57	4.74	4.10
25.0	2.80	1.82	3.37	2.22	3.81	2.53	4.30	3.27	4.60	3.57	4.74	4.10
30.0	2.80	1.82	3.37	2.22	3.81	2.53	4.30	3.27	4.60	3.57	4.74	4.10
35.0	2.80	1.82	3.37	2.22	3.81	2.53	4.30	3.27	4.60	3.57	4.74	4.10
40.0	2.65	1.63	3.19	1.98	3.60	2.26	4.07	2.93	4.35	3.20	4.48	3.67
46.0	2.50	1.45	3.01	1.76	3.40	2.01	3.84	2.60	4.10	2.85	4.23	3.26

MODELS: ASYG14LMCA, ASYG14LMCE, and ASYG14LUCA

Outdoor temperature	Indoor temperature (°CDB / °CWB)											
	18.0 / 12.0		21.0 / 15.0		23.0 / 16.0		27.0 / 19.0		29.0 / 21.0		32.0 / 23.0	
(°CDB)	TC	SHC	TC	SHC	TC	SHC	TC	SHC	TC	SHC	TC	SHC
-10.0	3.26	2.09	3.93	2.55	4.44	2.90	5.01	3.76	5.36	4.11	5.52	4.71
-5.0	3.26	2.09	3.93	2.55	4.44	2.90	5.01	3.76	5.36	4.11	5.52	4.71
0.0	3.26	2.09	3.93	2.55	4.44	2.90	5.01	3.76	5.36	4.11	5.52	4.71
5.0	3.26	2.09	3.93	2.55	4.44	2.90	5.01	3.76	5.36	4.11	5.52	4.71
10.0	3.26	2.09	3.93	2.55	4.44	2.90	5.01	3.76	5.36	4.11	5.52	4.71
15.0	3.26	2.09	3.93	2.55	4.44	2.90	5.01	3.76	5.36	4.11	5.52	4.71
20.0	3.26	2.09	3.93	2.55	4.44	2.90	5.01	3.76	5.36	4.11	5.52	4.71
25.0	3.26	2.09	3.93	2.55	4.44	2.90	5.01	3.76	5.36	4.11	5.52	4.71
30.0	3.26	2.09	3.93	2.55	4.44	2.90	5.01	3.76	5.36	4.11	5.52	4.71
35.0	3.26	2.09	3.93	2.55	4.44	2.90	5.01	3.76	5.36	4.11	5.52	4.71
40.0	3.09	1.87	3.72	2.28	4.20	2.60	4.74	3.36	5.07	3.68	5.22	4.22
46.0	2.91	1.66	3.51	2.03	3.96	2.31	4.47	2.99	4.78	3.27	4.93	3.75

MODEL: ASYG18LFCA

Outdoor temperature	Indoor temperature (°CDB / °CWB)											
	18.0 / 12.0		21.0 / 15.0		23.0 / 16.0		27.0 / 19.0		29.0 / 21.0		32.0 / 23.0	
(°CDB)	TC	SHC	TC	SHC	TC	SHC	TC	SHC	TC	SHC	TC	SHC
-10.0	4.18	2.75	5.03	3.35	5.69	3.82	6.42	4.94	6.86	5.41	7.07	6.19
-5.0	4.18	2.75	5.03	3.35	5.69	3.82	6.42	4.94	6.86	5.41	7.07	6.19
0.0	4.18	2.75	5.03	3.35	5.69	3.82	6.42	4.94	6.86	5.41	7.07	6.19
5.0	4.18	2.75	5.03	3.35	5.69	3.82	6.42	4.94	6.86	5.41	7.07	6.19
10.0	4.18	2.75	5.03	3.35	5.69	3.82	6.42	4.94	6.86	5.41	7.07	6.19
15.0	4.18	2.75	5.03	3.35	5.69	3.82	6.42	4.94	6.86	5.41	7.07	6.19
20.0	4.18	2.75	5.03	3.35	5.69	3.82	6.42	4.94	6.86	5.41	7.07	6.19
25.0	4.18	2.75	5.03	3.35	5.69	3.82	6.42	4.94	6.86	5.41	7.07	6.19
30.0	4.18	2.75	5.03	3.35	5.69	3.82	6.42	4.94	6.86	5.41	7.07	6.19
35.0	4.18	2.75	5.03	3.35	5.69	3.82	6.42	4.94	6.86	5.41	7.07	6.19
40.0	3.96	2.46	4.76	3.00	5.38	3.42	6.07	4.43	6.49	4.84	6.69	5.55
46.0	3.73	2.19	4.49	2.67	5.08	3.04	5.73	3.94	6.12	4.31	6.31	4.93

OUTDOOR UNIT
AOYG36LBA5OUTDOOR UNIT
AOYG36LBA5**MODELS: ASYG24LFCA and ASYG24LFCC**

Outdoor temperature	Indoor temperature (°CDB / °CWB)											
	18.0 / 12.0		21.0 / 15.0		23.0 / 16.0		27.0 / 19.0		29.0 / 21.0		32.0 / 23.0	
(°CDB)	TC	SHC	TC	SHC	TC	SHC	TC	SHC	TC	SHC	TC	SHC
-10.0	5.60	3.34	6.73	4.08	7.61	4.65	8.59	6.01	9.18	6.58	9.47	7.53
-5.0	5.60	3.34	6.73	4.08	7.61	4.65	8.59	6.01	9.18	6.58	9.47	7.53
0.0	5.60	3.34	6.73	4.08	7.61	4.65	8.59	6.01	9.18	6.58	9.47	7.53
5.0	5.60	3.34	6.73	4.08	7.61	4.65	8.59	6.01	9.18	6.58	9.47	7.53
10.0	5.60	3.34	6.73	4.08	7.61	4.65	8.59	6.01	9.18	6.58	9.47	7.53
15.0	5.60	3.34	6.73	4.08	7.61	4.65	8.59	6.01	9.18	6.58	9.47	7.53
20.0	5.60	3.34	6.73	4.08	7.61	4.65	8.59	6.01	9.18	6.58	9.47	7.53
25.0	5.60	3.34	6.73	4.08	7.61	4.65	8.59	6.01	9.18	6.58	9.47	7.53
30.0	5.60	3.34	6.73	4.08	7.61	4.65	8.59	6.01	9.18	6.58	9.47	7.53
35.0	5.60	3.34	6.73	4.08	7.61	4.65	8.59	6.01	9.18	6.58	9.47	7.53
40.0	5.30	2.99	6.37	3.65	7.20	4.16	8.13	5.38	8.69	5.89	8.96	6.75
46.0	5.00	2.66	6.01	3.25	6.79	3.70	7.67	4.79	8.19	5.24	8.45	6.00

NOTES:

- TC: Total Capacity (kW), SHC: Sensible Heat Capacity (kW)
- Values mentioned in the table are based on the following conditions:
 - Pipe length: 5 m, Height difference: 0 m (Outdoor unit—Indoor unit)

■ Floor/Ceiling type

MODEL: ABYG14LVTA

Outdoor temperature	Indoor temperature (°CDB / °CWB)											
	18.0 / 12.0		21.0 / 15.0		23.0 / 16.0		27.0 / 19.0		29.0 / 21.0		32.0 / 23.0	
(°CDB)	TC	SHC	TC	SHC	TC	SHC	TC	SHC	TC	SHC	TC	SHC
-10.0	3.26	2.01	3.93	2.45	4.44	2.79	5.01	3.61	5.36	3.95	5.52	4.52
-5.0	3.26	2.01	3.93	2.45	4.44	2.79	5.01	3.61	5.36	3.95	5.52	4.52
0.0	3.26	2.01	3.93	2.45	4.44	2.79	5.01	3.61	5.36	3.95	5.52	4.52
5.0	3.26	2.01	3.93	2.45	4.44	2.79	5.01	3.61	5.36	3.95	5.52	4.52
10.0	3.26	2.01	3.93	2.45	4.44	2.79	5.01	3.61	5.36	3.95	5.52	4.52
15.0	3.26	2.01	3.93	2.45	4.44	2.79	5.01	3.61	5.36	3.95	5.52	4.52
20.0	3.26	2.01	3.93	2.45	4.44	2.79	5.01	3.61	5.36	3.95	5.52	4.52
25.0	3.26	2.01	3.93	2.45	4.44	2.79	5.01	3.61	5.36	3.95	5.52	4.52
30.0	3.26	2.01	3.93	2.45	4.44	2.79	5.01	3.61	5.36	3.95	5.52	4.52
35.0	3.26	2.01	3.93	2.45	4.44	2.79	5.01	3.61	5.36	3.95	5.52	4.52
40.0	3.09	1.80	3.72	2.19	4.20	2.50	4.74	3.23	5.07	3.53	5.22	4.05
46.0	2.91	1.60	3.51	1.95	3.96	2.22	4.47	2.87	4.78	3.14	4.93	3.60

MODEL: ABYG18LVTB

Outdoor temperature	Indoor temperature (°CDB / °CWB)											
	18.0 / 12.0		21.0 / 15.0		23.0 / 16.0		27.0 / 19.0		29.0 / 21.0		32.0 / 23.0	
(°CDB)	TC	SHC	TC	SHC	TC	SHC	TC	SHC	TC	SHC	TC	SHC
-10.0	4.18	2.50	5.03	3.05	5.69	3.47	6.42	4.49	6.86	4.60	7.07	5.63
-5.0	4.18	2.50	5.03	3.05	5.69	3.47	6.42	4.49	6.86	4.92	7.07	5.63
0.0	4.18	2.50	5.03	3.05	5.69	3.47	6.42	4.49	6.86	4.92	7.07	5.63
5.0	4.18	2.50	5.03	3.05	5.69	3.47	6.42	4.49	6.86	4.92	7.07	5.63
10.0	4.18	2.50	5.03	3.05	5.69	3.47	6.42	4.49	6.86	4.92	7.07	5.63
15.0	4.18	2.50	5.03	3.05	5.69	3.47	6.42	4.49	6.86	4.92	7.07	5.63
20.0	4.18	2.50	5.03	3.05	5.69	3.47	6.42	4.49	6.86	4.92	7.07	5.63
25.0	4.18	2.50	5.03	3.05	5.69	3.47	6.42	4.49	6.86	4.92	7.07	5.63
30.0	4.18	2.50	5.03	3.05	5.69	3.47	6.42	4.49	6.86	4.92	7.07	5.63
35.0	4.18	2.50	5.03	3.05	5.69	3.47	6.42	4.49	6.86	4.92	7.07	5.63
40.0	3.96	2.24	4.76	2.73	5.38	3.11	6.07	4.02	6.49	4.40	6.69	5.04
46.0	3.73	1.99	4.49	2.43	5.08	2.77	5.73	3.58	6.12	3.91	6.31	4.48

NOTES:

- TC: Total Capacity (kW), SHC: Sensible Heat Capacity (kW)
- Values mentioned in the table are based on the following conditions:
 - Pipe length: 5 m, Height difference: 0 m (Outdoor unit—Indoor unit)

■ Floor type

MODEL: AGYG09LVCA

Outdoor temperature	Indoor temperature (°CDB / °CWB)											
	18.0 / 12.0		21.0 / 15.0		23.0 / 16.0		27.0 / 19.0		29.0 / 21.0		32.0 / 23.0	
(°CDB)	TC	SHC	TC	SHC	TC	SHC	TC	SHC	TC	SHC	TC	SHC
-10.0	2.10	1.42	2.52	1.73	2.85	1.97	3.22	2.54	3.44	2.78	3.55	3.19
-5.0	2.10	1.42	2.52	1.73	2.85	1.97	3.22	2.54	3.44	2.78	3.55	3.19
0.0	2.10	1.42	2.52	1.73	2.85	1.97	3.22	2.54	3.44	2.78	3.55	3.19
5.0	2.10	1.42	2.52	1.73	2.85	1.97	3.22	2.54	3.44	2.78	3.55	3.19
10.0	2.10	1.42	2.52	1.73	2.85	1.97	3.22	2.54	3.44	2.78	3.55	3.19
15.0	2.10	1.42	2.52	1.73	2.85	1.97	3.22	2.54	3.44	2.78	3.55	3.19
20.0	2.10	1.42	2.52	1.73	2.85	1.97	3.22	2.54	3.44	2.78	3.55	3.19
25.0	2.10	1.42	2.52	1.73	2.85	1.97	3.22	2.54	3.44	2.78	3.55	3.19
30.0	2.10	1.42	2.52	1.73	2.85	1.97	3.22	2.54	3.44	2.78	3.55	3.19
35.0	2.10	1.42	2.52	1.73	2.85	1.97	3.22	2.54	3.44	2.78	3.55	3.19
40.0	1.99	1.27	2.39	1.54	2.70	1.76	3.05	2.28	3.26	2.49	3.36	2.85
46.0	1.87	1.13	2.25	1.37	2.55	1.57	2.87	2.03	3.07	2.22	3.17	2.54

OUTDOOR UNIT
AOYG36LBA5OUTDOOR UNIT
AOYG36LBA5

MODEL: AGYG12LVCA

Outdoor temperature	Indoor temperature (°CDB / °CWB)											
	18.0 / 12.0		21.0 / 15.0		23.0 / 16.0		27.0 / 19.0		29.0 / 21.0		32.0 / 23.0	
(°CDB)	TC	SHC	TC	SHC	TC	SHC	TC	SHC	TC	SHC	TC	SHC
-10.0	2.80	1.77	3.37	2.16	3.81	2.46	4.30	3.18	4.60	3.48	4.74	3.99
-5.0	2.80	1.77	3.37	2.16	3.81	2.46	4.30	3.18	4.60	3.48	4.74	3.99
0.0	2.80	1.77	3.37	2.16	3.81	2.46	4.30	3.18	4.60	3.48	4.74	3.99
5.0	2.80	1.77	3.37	2.16	3.81	2.46	4.30	3.18	4.60	3.48	4.74	3.99
10.0	2.80	1.77	3.37	2.16	3.81	2.46	4.30	3.18	4.60	3.48	4.74	3.99
15.0	2.80	1.77	3.37	2.16	3.81	2.46	4.30	3.18	4.60	3.48	4.74	3.99
20.0	2.80	1.77	3.37	2.16	3.81	2.46	4.30	3.18	4.60	3.48	4.74	3.99
25.0	2.80	1.77	3.37	2.16	3.81	2.46	4.30	3.18	4.60	3.48	4.74	3.99
30.0	2.80	1.77	3.37	2.16	3.81	2.46	4.30	3.18	4.60	3.48	4.74	3.99
35.0	2.80	1.77	3.37	2.16	3.81	2.46	4.30	3.18	4.60	3.48	4.74	3.99
40.0	2.65	1.58	3.19	1.93	3.60	2.20	4.07	2.85	4.35	3.12	4.48	3.57
46.0	2.50	1.41	3.01	1.72	3.40	1.96	3.84	2.53	4.10	2.77	4.23	3.18

MODEL: AGYG14LVCA

Outdoor temperature	Indoor temperature (°CDB / °CWB)											
	18.0 / 12.0		21.0 / 15.0		23.0 / 16.0		27.0 / 19.0		29.0 / 21.0		32.0 / 23.0	
(°CDB)	TC	SHC	TC	SHC	TC	SHC	TC	SHC	TC	SHC	TC	SHC
-10.0	3.26	2.01	3.93	2.45	4.44	2.79	5.01	3.61	5.36	3.95	5.52	4.52
-5.0	3.26	2.01	3.93	2.45	4.44	2.79	5.01	3.61	5.36	3.95	5.52	4.52
0.0	3.26	2.01	3.93	2.45	4.44	2.79	5.01	3.61	5.36	3.95	5.52	4.52
5.0	3.26	2.01	3.93	2.45	4.44	2.79	5.01	3.61	5.36	3.95	5.52	4.52
10.0	3.26	2.01	3.93	2.45	4.44	2.79	5.01	3.61	5.36	3.95	5.52	4.52
15.0	3.26	2.01	3.93	2.45	4.44	2.79	5.01	3.61	5.36	3.95	5.52	4.52
20.0	3.26	2.01	3.93	2.45	4.44	2.79	5.01	3.61	5.36	3.95	5.52	4.52
25.0	3.26	2.01	3.93	2.45	4.44	2.79	5.01	3.61	5.36	3.95	5.52	4.52
30.0	3.26	2.01	3.93	2.45	4.44	2.79	5.01	3.61	5.36	3.95	5.52	4.52
35.0	3.26	2.01	3.93	2.45	4.44	2.79	5.01	3.61	5.36	3.95	5.52	4.52
40.0	3.09	1.80	3.72	2.19	4.20	2.50	4.74	3.23	5.07	3.53	5.22	4.05
46.0	2.91	1.60	3.51	1.95	3.96	2.22	4.47	2.87	4.78	3.14	4.93	3.60

NOTES:

- TC: Total Capacity (kW), SHC: Sensible Heat Capacity (kW)
- Values mentioned in the table are based on the following conditions:
 - Pipe length: 5 m, Height difference: 0 m [Outdoor unit—Indoor unit]

6-3. Heating capacity

Model: AOYG36LBLA5

NOTE: Values mentioned in the table are calculated based on the maximum capacity.

OUTDOOR UNIT
AOYG36LBLA5

OUTDOOR UNIT
AOYG36LBLA5

Indoor unit connecting capacity	Outdoor temperature		Indoor temperature									
			16.0 °CDB		18.0 °CDB		20.0 °CDB		22.0 °CDB		24.0 °CDB	
kBtu/h	°CDB	°CWB	TC	IP	TC	IP	TC	IP	TC	IP	TC	IP
54	-15.0	-16.0	10.28	4.30	9.79	4.30	9.40	4.30	9.20	4.29	9.01	4.28
	-10.0	-11.0	11.50	4.30	10.96	4.30	10.60	4.30	10.38	4.29	10.15	4.28
	-5.0	-7.0	12.78	4.30	12.24	4.30	11.80	4.30	11.62	4.29	11.45	4.28
	0.0	-2.0	14.08	4.30	13.54	4.30	13.00	4.30	12.69	4.28	12.37	4.26
	5.0	3.0	15.87	4.30	15.12	4.30	14.00	4.30	13.53	4.17	13.07	4.05
	7.0	6.0	16.19	4.14	15.23	4.06	14.00	3.98	13.34	3.78	12.69	3.57
	10.0	8.0	16.07	4.13	15.12	4.05	14.00	3.97	13.35	3.86	12.70	3.75
	15.0	10.0	16.05	4.14	15.02	4.06	14.00	3.94	13.40	3.82	12.80	3.70
53	20.0	15.0	15.93	3.97	14.92	3.89	14.00	3.78	13.46	3.66	12.91	3.54
	24.0	18.0	15.73	3.83	14.82	3.76	14.00	3.65	13.75	3.62	13.51	3.58
	-15.0	-16.0	10.28	4.30	9.79	4.30	9.40	4.30	9.20	4.29	9.01	4.28
	-10.0	-11.0	11.50	4.30	10.96	4.30	10.60	4.30	10.38	4.29	10.15	4.28
	-5.0	-7.0	12.78	4.30	12.24	4.30	11.80	4.30	11.62	4.29	11.45	4.28
	0.0	-2.0	14.08	4.30	13.54	4.30	13.00	4.30	12.69	4.28	12.37	4.26
	5.0	3.0	15.87	4.30	15.12	4.30	14.00	4.30	13.53	4.17	13.07	4.05
	7.0	6.0	16.19	4.14	15.23	4.06	14.00	3.98	13.34	3.78	12.69	3.57
52	10.0	8.0	16.07	4.13	15.12	4.05	14.00	3.97	13.35	3.86	12.70	3.75
	15.0	10.0	16.05	4.14	15.02	4.06	14.00	3.94	13.40	3.82	12.80	3.70
	20.0	15.0	15.93	3.97	14.92	3.89	14.00	3.78	13.46	3.66	12.91	3.54
	24.0	18.0	15.73	3.83	14.82	3.76	14.00	3.65	13.75	3.62	13.51	3.58
	-15.0	-16.0	10.28	4.30	9.79	4.30	9.40	4.30	9.20	4.29	9.01	4.28
	-10.0	-11.0	11.50	4.30	10.96	4.30	10.60	4.30	10.38	4.29	10.15	4.28
	-5.0	-7.0	12.78	4.30	12.24	4.30	11.80	4.30	11.62	4.29	11.45	4.28
	0.0	-2.0	14.08	4.30	13.54	4.30	13.00	4.30	12.69	4.28	12.37	4.26
51	5.0	3.0	15.87	4.30	15.12	4.30	14.00	4.30	13.53	4.17	13.07	4.05
	7.0	6.0	16.19	4.14	15.23	4.06	14.00	3.98	13.34	3.78	12.69	3.57
	10.0	8.0	16.07	4.13	15.12	4.05	14.00	3.97	13.35	3.86	12.70	3.75
	15.0	10.0	16.05	4.14	15.02	4.06	14.00	3.94	13.40	3.82	12.80	3.70
	20.0	15.0	15.93	3.97	14.92	3.89	14.00	3.78	13.46	3.66	12.91	3.54
	24.0	18.0	15.73	3.83	14.82	3.76	14.00	3.65	13.75	3.62	13.51	3.58
	-15.0	-16.0	10.28	4.30	9.79	4.30	9.40	4.30	9.20	4.29	9.01	4.28
	-10.0	-11.0	11.50	4.30	10.96	4.30	10.60	4.30	10.38	4.29	10.15	4.28
50	-5.0	-7.0	12.78	4.30	12.24	4.30	11.80	4.30	11.62	4.29	11.45	4.28
	0.0	-2.0	14.08	4.30	13.54	4.30	13.00	4.30	12.69	4.28	12.37	4.26
	5.0	3.0	15.87	4.30	15.12	4.30	14.00	4.30	13.53	4.17	13.07	4.05
	7.0	6.0	16.19	4.14	15.23	4.06	14.00	3.98	13.34	3.78	12.69	3.57
	10.0	8.0	16.07	4.13	15.12	4.05	14.00	3.97	13.35	3.86	12.70	3.75
	15.0	10.0	16.05	4.14	15.02	4.06	14.00	3.94	13.40	3.82	12.80	3.70
	20.0	15.0	15.93	3.97	14.92	3.89	14.00	3.78	13.46	3.66	12.91	3.54
	24.0	18.0	15.73	3.83	14.82	3.76	14.00	3.65	13.75	3.62	13.51	3.58
49	-15.0	-16.0	10.28	4.30	9.79	4.30	9.40	4.30	9.20	4.29	9.01	4.28
	-10.0	-11.0	11.50	4.30	10.96	4.30	10.60	4.30	10.38	4.29	10.15	4.28
	-5.0	-7.0	12.78	4.30	12.24	4.30	11.80	4.30	11.62	4.29	11.45	4.28
	0.0	-2.0	14.08	4.30	13.54	4.30	13.00	4.30	12.69	4.28	12.37	4.26
	5.0	3.0	15.87	4.30	15.12	4.30	14.00	4.30	13.53	4.17	13.07	4.05
	7.0	6.0	16.19	4.14	15.23	4.06	14.00	3.98	13.34	3.78	12.69	3.57
	10.0	8.0	16.07	4.13	15.12	4.05	14.00	3.97	13.35	3.86	12.70	3.75
	15.0	10.0	16.05	4.14	15.02	4.06	14.00	3.94	13.40	3.82	12.80	3.70
48	20.0	15.0	15.93	3.97	14.92	3.89	14.00	3.78	13.46	3.66	12.91	3.54
	24.0	18.0	15.73	3.83	14.82	3.76	14.00	3.65	13.75	3.62	13.51	3.58
	-15.0	-16.0	10.28	4.30	9.79	4.30	9.40	4.30	9.20	4.29	9.01	4.28
	-10.0	-11.0	11.50	4.30	10.96	4.30	10.60	4.30	10.38	4.29	10.15	4.28
	-5.0	-7.0	12.78	4.30	12.24	4.30	11.80	4.30	11.62	4.29	11.45	4.28
	0.0	-2.0	14.08	4.30	13.54	4.30	13.00	4.30	12.69	4.28	12.37	4.26
	5.0	3.0	15.87	4.30	15.12	4.30	14.00	4.30	13.53	4.17	13.07	4.05
	7.0	6.0	16.19	4.14	15.23	4.06	14.00	3.98	13.34	3.78	12.69	3.57
47	10.0	8.0	16.07	4.13	15.12	4.05	14.00	3.97	13.35	3.86	12.70	3.75
	15.0	10.0	16.05	4.14	15.02	4.06	14.00	3.94	13.40	3.82	12.80	3.70
	20.0	15.0	15.93	3.97	14.92	3.89	14.00	3.78	13.46	3.66	12.91	3.54
	24.0	18.0	15.73	3.83	14.82	3.76	14.00	3.65	13.75	3.62	13.51	3.58
	-15.0	-16.0	10.28	4.30	9.79	4.30	9.40	4.30	9.20	4.29	9.01	4.28
	-10.0	-11.0	11.50	4.30	10.96	4.30	10.60	4.30	10.38	4.29	10.15	4.28
	-5.0	-7.0	12.78	4.30	12.24	4.30	11.80	4.30	11.62	4.29	11.45	4.28
	0.0	-2.0	14.08	4.30	13.54	4.30	13.00	4.30	12.69	4.28	12.37	4.26

OUTDOOR UNIT
AOYG36LBA5

OUTDOOR UNIT
AOYG36LBA5

Indoor unit connecting capacity	Outdoor temperature		Indoor temperature									
			16.0 °CDB		18.0 °CDB		20.0 °CDB		22.0 °CDB		24.0 °CDB	
	kBtu/h	°CDB	°CWB	TC	IP	TC	IP	TC	IP	TC	IP	TC
37	-15.0	-16.0	10.28	4.30	9.79	4.30	9.40	4.30	9.20	4.29	9.01	4.28
	-10.0	-11.0	11.50	4.30	10.96	4.30	10.60	4.30	10.38	4.29	10.15	4.28
	-5.0	-7.0	12.78	4.30	12.24	4.30	11.80	4.30	11.62	4.29	11.45	4.28
	0.0	-2.0	14.08	4.30	13.54	4.30	13.00	4.30	12.69	4.28	12.37	4.26
	5.0	3.0	15.87	4.30	15.12	4.30	14.00	4.30	13.53	4.17	13.07	4.05
	7.0	6.0	16.19	4.14	15.23	4.06	14.00	3.98	13.34	3.78	12.69	3.57
	10.0	8.0	16.07	4.13	15.12	4.05	14.00	3.97	13.35	3.86	12.70	3.75
	15.0	10.0	16.05	4.14	15.02	4.06	14.00	3.94	13.40	3.82	12.80	3.70
	20.0	15.0	15.93	3.97	14.92	3.89	14.00	3.78	13.46	3.66	12.91	3.54
	24.0	18.0	15.73	3.83	14.82	3.76	14.00	3.65	13.75	3.62	13.51	3.58
36	-15.0	-16.0	10.28	4.30	9.79	4.30	9.40	4.30	9.20	4.29	9.01	4.28
	-10.0	-11.0	11.50	4.30	10.96	4.30	10.60	4.30	10.38	4.29	10.15	4.28
	-5.0	-7.0	12.78	4.30	12.24	4.30	11.80	4.30	11.62	4.29	11.45	4.28
	0.0	-2.0	14.08	4.30	13.54	4.30	13.00	4.30	12.69	4.28	12.37	4.26
	5.0	3.0	15.87	4.30	15.12	4.30	14.00	4.30	13.53	4.17	13.07	4.05
	7.0	6.0	16.19	4.14	15.23	4.06	14.00	3.98	13.34	3.78	12.69	3.57
	10.0	8.0	16.07	4.13	15.12	4.05	14.00	3.97	13.35	3.86	12.70	3.75
	15.0	10.0	16.05	4.14	15.02	4.06	14.00	3.94	13.40	3.82	12.80	3.70
	20.0	15.0	15.93	3.97	14.92	3.89	14.00	3.78	13.46	3.66	12.91	3.54
	24.0	18.0	15.73	3.83	14.82	3.76	14.00	3.65	13.75	3.62	13.51	3.58
35	-15.0	-16.0	10.28	4.30	9.79	4.30	9.40	4.30	9.20	4.29	9.01	4.28
	-10.0	-11.0	11.50	4.30	10.96	4.30	10.60	4.30	10.38	4.29	10.15	4.28
	-5.0	-7.0	12.78	4.30	12.24	4.30	11.80	4.30	11.62	4.29	11.45	4.28
	0.0	-2.0	14.08	4.30	13.54	4.30	13.00	4.30	12.69	4.28	12.37	4.26
	5.0	3.0	15.87	4.30	15.12	4.30	14.00	4.30	13.53	4.17	13.07	4.05
	7.0	6.0	16.19	4.14	15.23	4.06	14.00	3.98	13.34	3.78	12.69	3.57
	10.0	8.0	16.07	4.13	15.12	4.05	14.00	3.97	13.35	3.86	12.70	3.75
	15.0	10.0	16.05	4.14	15.02	4.06	14.00	3.94	13.40	3.82	12.80	3.70
	20.0	15.0	15.93	3.97	14.92	3.89	14.00	3.78	13.46	3.66	12.91	3.54
	24.0	18.0	15.73	3.83	14.82	3.76	14.00	3.65	13.75	3.62	13.51	3.58
34	-15.0	-16.0	9.99	4.18	9.51	4.18	9.13	4.18	8.94	4.17	8.75	4.16
	-10.0	-11.0	11.17	4.18	10.65	4.18	10.30	4.18	10.08	4.17	9.86	4.16
	-5.0	-7.0	12.41	4.18	11.89	4.18	11.46	4.18	11.29	4.17	11.12	4.16
	0.0	-2.0	13.67	4.18	13.15	4.18	12.63	4.18	12.32	4.16	12.02	4.14
	5.0	3.0	15.41	4.18	14.69	4.18	13.60	4.18	13.15	4.06	12.69	3.93
	7.0	6.0	15.73	4.02	14.79	3.94	13.60	3.86	12.96	3.66	12.33	3.47
	10.0	8.0	15.61	4.01	14.69	3.93	13.60	3.85	12.97	3.74	12.34	3.63
	15.0	10.0	15.59	4.01	14.60	3.94	13.60	3.82	13.02	3.71	12.44	3.59
	20.0	15.0	15.47	3.85	14.50	3.78	13.60	3.67	13.07	3.55	12.54	3.43
	24.0	18.0	15.28	3.72	14.40	3.65	13.60	3.54	13.36	3.51	13.12	3.47
33	-15.0	-16.0	9.69	4.04	9.23	4.04	8.86	4.04	8.68	4.03	8.49	4.03
	-10.0	-11.0	10.84	4.04	10.33	4.04	9.99	4.04	9.78	4.03	9.57	4.03
	-5.0	-7.0	12.05	4.04	11.54	4.04	11.13	4.04	10.96	4.03	10.79	4.02
	0.0	-2.0	13.27	4.04	12.76	4.04	12.26	4.04	11.96	4.02	11.67	4.00
	5.0	3.0	14.96	4.04	14.26	4.04	13.20	4.04	12.76	3.92	12.32	3.80
	7.0	6.0	15.26	3.89	14.36	3.82	13.20	3.74	12.58	3.55	11.96	3.36
	10.0	8.0	15.16	3.88	14.26	3.81	13.20	3.73	12.59	3.63	11.98	3.52
	15.0	10.0	15.13	3.89	14.17	3.81	13.20	3.70	12.64	3.59	12.07	3.48
	20.0	15.0	15.02	3.73	14.07	3.66	13.20	3.55	12.69	3.44	12.17	3.32
	24.0	18.0	14.83	3.60	13.98	3.53	13.20	3.43	12.97	3.40	12.73	3.36
32	-15.0	-16.0	9.40	3.91	8.95	3.91	8.59	3.91	8.42	3.90	8.24	3.90
	-10.0	-11.0	10.51	3.91	10.02	3.91	9.69	3.91	9.49	3.90	9.28	3.90
	-5.0	-7.0	11.68	3.91	11.19	3.91	10.79	3.91	10.63	3.90	10.46	3.89
	0.0	-2.0	12.87	3.91	12.38	3.91	11.89	3.91	11.60	3.89	11.31	3.87
	5.0	3.0	14.51	3.91	13.82	3.91	12.80	3.91	12.37	3.79	11.95	3.68
	7.0	6.0	14.80	3.76	13.92	3.69	12.80	3.62	12.20	3.43	11.60	3.25
	10.0	8.0	14.70	3.76	13.83	3.68	12.80	3.61	12.21	3.51	11.61	3.41
	15.0	10.0	14.67	3.76	13.74	3.69	12.80	3.58	12.25	3.47	11.71	3.37
	20.0	15.0	14.56	3.61	13.64	3.54	12.80	3.44	12.30	3.33	11.80	3.22
	24.0	18.0	14.38	3.48	13.55	3.42	12.80	3.32	12.57	3.29	12.35	3.25
31	-15.0	-16.0	9.11	3.78	8.67	3.78	8.33	3.78	8.15	3.77	7.98	3.77
	-10.0	-11.0	10.18	3.78	9.71	3.78	9.39	3.78	9.19	3.77	8.99	3.77
	-5.0	-7.0	11.32	3.78	10.84	3.78	10.45	3.78	10.29	3.77	10.14	3.76
	0.0	-2.0	12.47	3.78	11.99	3.78	11.51	3.78	11.24	3.76	10.96	3.74
	5.0	3.0	14.05	3.78	13.39	3.78	12.40	3.78	11.99	3.67	11.57	3.56
	7.0	6.0	14.34	3.64	13.49	3.57	12.40	3.50	11.82	3.32	11.24	3.14
	10.0	8.0	14.24	3.63	13.40	3.56	12.40	3.49	11.83	3.39	11.25	3.29
	15.0	10.0	14.21	3.64	13.31	3.57	12.40	3.46	11.87	3.36	11.34	3.25
	20.0	15.0	14.11	3.49	13.22	3.42	12.40	3.32	11.92	3.22	11.43	3.11
	24.0	18.0	13.93	3.37	13.13	3.30	12.40	3.21	12.18	3.18	11.96	3.14
30	-15.0	-16.0	8.81	3.65	8.39	3.65	8.06	3.65	7.89	3.64	7.72	3.64
	-10.0	-11.0	9.86	3.65	9.39	3.65	9.09	3.65	8.89	3.64	8.70	3.64
	-5.0	-7.0	10.95	3.65	10.49	3.65	10.11	3.65	9.96	3.64	9.81	3.63
	0.0	-2.0	12.07	3.65	11.60	3.65	11.14	3.65	10.87	3.63	10.60	3.61
	5.0	3.0	13.60	3.65	12.96	3.65	12.00	3.65	11.60	3.54	11.20	3.43
	7.0	6.0	13.88	3.51	13.05	3.45	12.00	3.38	11.44	3.21	10.88	3.03
	10.0	8.0	13.78	3.51	12.96	3.44	12.00	3.37	11.44	3.28	10.89	3.18
	15.0	10.0	13.76	3.51	12.88	3.45	12.00	3.34	11.49	3.24	10.98	3.14
	20.0	15.0	13.65	3.37	12.79	3.30	12.00	3.21	11.53	3.10	11.07	3.00
	24.0	18.0	13.48	3.25	12.71	3.19	12.00	3.10	11.79	3.07	11.58	3.04
29	-15.0	-16.0	8.52	3.52	8.11	3.52	7.79	3.52	7.63	3.51	7.46	3.51
	-10.0	-11.0	9.53	3.52	9.08	3.52	8.78	3.52	8.60	3.51	8.41	3.51
	-5.0	-7.0	10.59	3.52	10.14	3.52	9.78	3.52	9.63	3.51	9.48	3.50
	0.0	-2.0	11.66	3.52	11.22	3.52	10.77	3.52	10.51	3.50	10.25	3.48
	5.0	3.0	13.15	3.52	12.53	3.52	11.60	3.52	11.21	3.42	10.83	3.31
	7.0	6.0	13.41	3.39	12.62	3.32	11.60	3.26	11.06	3.09	10.51	2.92
	10.0	8.0	13.32	3.38	12.53	3.31	11.60	3.25	11.06	3.16	10.53	3.07
	15.0	10.0	13.30	3.39	12.45	3.32	11.60	3.23	11.10	3.13	10.61	3.03
	20.0	15.0	13.20	3.25	12.36	3.19	11.60	3.09	11.15	2.99	10.70	2.89
	24.0	18.0	13.03	3.14	12.28	3.08	11.60	2.99	11.40	2.96	11.19	2.93

Indoor unit connecting capacity	Outdoor temperature		Indoor temperature									
			16.0 °CDB		18.0 °CDB		20.0 °CDB		22.0 °CDB		24.0 °CDB	
	kBtu/h	°CDB	°CWB	TC	IP	TC	IP	TC	IP	TC	IP	TC
28	-15.0	-16.0	8.23	3.39	7.83	3.39	7.52	3.39	7.36	3.38	7.21	3.38
	-10.0	-11.0	9.20	3.39	8.77	3.39	8.48	3.39	8.30	3.38	8.12	3.38
	-5.0	-7.0	10.22	3.39	9.79	3.39	9.44	3.39	9.30	3.38	9.16	3.37
	0.0	-2.0	11.26	3.39	10.83	3.39	10.40	3.39	10.15	3.37	9.90	3.35
	5.0	3.0	12.69	3.39	12.10	3.39	11.20	3.39	10.83	3.29	10.45	3.19
	7.0	6.0	12.95	3.26	12.18	3.20	11.20	3.14	10.68	2.98	10.15	2.82
	10.0	8.0	12.86	3.25	12.10	3.19	11.20	3.13	10.68	3.04	10.16	2.95
	15.0	10.0	12.84	3.26	12.02	3.20	11.20	3.11	10.72	3.01	10.24	2.92
	20.0	15.0	12.74	3.13	11.94	3.07	11.20	2.98	10.76	2.88	10.33	2.79
	24.0	18.0	12.58	3.02	11.86	2.96	11.20	2.88	11.00	2.85	10.80	2.82
27	-15.0	-16.0	7.93	3.26	7.55	3.26	7.25	3.26	7.10	3.25	6.95	3.25
	-10.0	-11.0	8.87	3.26	8.45	3.26	8.18	3.26	8.00	3.25	7.83	3.25
	-5.0	-7.0	9.86	3.26	9.45	3.26	9.10	3.26	8.97	3.25	8.83	3.24
	0.0	-2.0	10.86	3.26	10.44	3.26	10.03	3.26	9.79	3.24	9.54	3.23
	5.0	3.0	12.24	3.26	11.66	3.26	10.80	3.26	10.44	3.16	10.08	3.07
	7.0	6.0	12.49	3.14	11.75	3.08	10.80	3.02	10.29	2.86	9.79	2.71
	10.0	8.0	12.40	3.13	11.67	3.07	10.80	3.01	10.30	2.92	9.80	2.84
	15.0	10.0	12.38	3.14	11.59	3.08	10.80	2.99	10.34	2.90	9.88	2.81
	20.0	15.0	12.29	3.01	11.51	2.95	10.80	2.86	10.38	2.77	9.96	2.68
	24.0	18.0	12.13	2.90	11.44	2.85	10.80	2.77	10.61	2.74	10.42	2.71

OUTDOOR UNIT
AOYG36LBA5

OUTDOOR UNIT
AOYG36LBA5

NOTES:

- TC: Total Capacity (kW), IP: Input Power (kW)
- Values mentioned in the table are based on the following conditions:
 - Power source of specifications: 230 V
 - Pipe length: 5 m, Height difference: 0 m (Outdoor unit—Indoor unit)
- 2 or more indoor units should be connected.
- The total ability of connected a indoor unit is from 27,000 Btu up to 54,000 Btu.
- Input in the table are calculated based on the maximum indoor unit input combinations.

■ Compact cassette type

MODEL: AUYG07LVLA

Outdoor temperature		Indoor temperature (°CDB)				
		16.0	18.0	20.0	22.0	24.0
(°CDB)	(°CWB)	TC	TC	TC	TC	TC
-15.0	-16.0	2.06	1.96	1.88	1.84	1.80
-10.0	-11.0	2.30	2.19	2.12	2.08	2.03
-5.0	-7.0	2.56	2.45	2.36	2.32	2.29
0.0	-2.0	2.82	2.71	2.60	2.54	2.47
5.0	3.0	3.17	3.02	2.80	2.71	2.61
7.0	6.0	3.24	3.05	2.80	2.67	2.54
10.0	8.0	3.21	3.02	2.80	2.67	2.54
15.0	10.0	3.21	3.00	2.80	2.68	2.56
20.0	15.0	3.19	2.98	2.80	2.69	2.58
24.0	18.0	3.15	2.96	2.80	2.75	2.70

MODEL: AUYG09LVLA

Outdoor temperature		Indoor temperature (°CDB)				
		16.0	18.0	20.0	22.0	24.0
(°CDB)	(°CWB)	TC	TC	TC	TC	TC
-15.0	-16.0	2.64	2.52	2.42	2.37	2.32
-10.0	-11.0	2.96	2.82	2.73	2.67	2.61
-5.0	-7.0	3.29	3.15	3.03	2.99	2.94
0.0	-2.0	3.62	3.48	3.34	3.26	3.18
5.0	3.0	4.08	3.89	3.60	3.48	3.36
7.0	6.0	4.16	3.92	3.60	3.43	3.26
10.0	8.0	4.13	3.89	3.60	3.43	3.27
15.0	10.0	4.13	3.86	3.60	3.45	3.29
20.0	15.0	4.10	3.84	3.60	3.46	3.32
24.0	18.0	4.04	3.81	3.60	3.54	3.47

MODEL: AUYG12LVLB

Outdoor temperature		Indoor temperature (°CDB)				
		16.0	18.0	20.0	22.0	24.0
(°CDB)	(°CWB)	TC	TC	TC	TC	TC
-15.0	-16.0	3.53	3.36	3.22	3.16	3.09
-10.0	-11.0	3.94	3.76	3.63	3.56	3.48
-5.0	-7.0	4.38	4.20	4.05	3.98	3.92
0.0	-2.0	4.83	4.64	4.46	4.35	4.24
5.0	3.0	5.44	5.18	4.80	4.64	4.48
7.0	6.0	5.55	5.22	4.80	4.58	4.35
10.0	8.0	5.51	5.19	4.80	4.58	4.36
15.0	10.0	5.50	5.15	4.80	4.60	4.39
20.0	15.0	5.46	5.12	4.80	4.61	4.43
24.0	18.0	5.39	5.08	4.80	4.72	4.63

MODEL: AUYG14LVLB

Outdoor temperature		Indoor temperature (°CDB)				
		16.0	18.0	20.0	22.0	24.0
(°CDB)	(°CWB)	TC	TC	TC	TC	TC
-15.0	-16.0	4.11	3.92	3.76	3.68	3.60
-10.0	-11.0	4.60	4.38	4.24	4.15	4.06
-5.0	-7.0	5.11	4.90	4.72	4.65	4.58
0.0	-2.0	5.63	5.42	5.20	5.07	4.95
5.0	3.0	6.35	6.05	5.60	5.41	5.23
7.0	6.0	6.48	6.09	5.60	5.34	5.08
10.0	8.0	6.43	6.05	5.60	5.34	5.08
15.0	10.0	6.42	6.01	5.60	5.36	5.12
20.0	15.0	6.37	5.97	5.60	5.38	5.16
24.0	18.0	6.29	5.93	5.60	5.50	5.40

MODEL: AUYG18LVLB

Outdoor temperature		Indoor temperature (°CDB)				
		16.0	18.0	20.0	22.0	24.0
(°CDB)	(°CWB)	TC	TC	TC	TC	TC
-15.0	-16.0	5.29	5.04	4.83	4.73	4.63
-10.0	-11.0	5.91	5.64	5.45	5.34	5.22
-5.0	-7.0	6.57	6.30	6.07	5.98	5.89
0.0	-2.0	7.24	6.96	6.69	6.52	6.36
5.0	3.0	8.16	7.78	7.20	6.96	6.72
7.0	6.0	8.33	7.83	7.20	6.86	6.53
10.0	8.0	8.27	7.78	7.20	6.87	6.53
15.0	10.0	8.25	7.73	7.20	6.89	6.59
20.0	15.0	8.19	7.67	7.20	6.92	6.64
24.0	18.0	8.09	7.62	7.20	7.07	6.95

NOTES:

- TC: Total Capacity (kW)
- Values mentioned in the table are based on the following conditions:
 - Pipe length: 5 m, Height difference: 0 m (Outdoor unit—Indoor unit)

■ Mini duct type

MODEL: ARYG07LSLAP

Outdoor temperature		Indoor temperature (°CDB)				
		16.0	18.0	20.0	22.0	24.0
(°CDB)	(°CWB)	TC	TC	TC	TC	TC
-15.0	-16.0	2.06	1.96	1.88	1.84	1.80
-10.0	-11.0	2.30	2.19	2.12	2.08	2.03
-5.0	-7.0	2.56	2.45	2.36	2.32	2.29
0.0	-2.0	2.82	2.71	2.60	2.54	2.47
5.0	3.0	3.17	3.02	2.80	2.71	2.61
7.0	6.0	3.24	3.05	2.80	2.67	2.54
10.0	8.0	3.21	3.02	2.80	2.67	2.54
15.0	10.0	3.21	3.00	2.80	2.68	2.56
20.0	15.0	3.19	2.98	2.80	2.69	2.58
24.0	18.0	3.15	2.96	2.80	2.75	2.70

MODEL: ARYG09LSLAP

Outdoor temperature		Indoor temperature (°CDB)				
		16.0	18.0	20.0	22.0	24.0
(°CDB)	(°CWB)	TC	TC	TC	TC	TC
-15.0	-16.0	2.64	2.52	2.42	2.37	2.32
-10.0	-11.0	2.96	2.82	2.73	2.67	2.61
-5.0	-7.0	3.29	3.15	3.03	2.99	2.94
0.0	-2.0	3.62	3.48	3.34	3.26	3.18
5.0	3.0	4.08	3.89	3.60	3.48	3.36
7.0	6.0	4.16	3.92	3.60	3.43	3.26
10.0	8.0	4.13	3.89	3.60	3.43	3.27
15.0	10.0	4.13	3.86	3.60	3.45	3.29
20.0	15.0	4.10	3.84	3.60	3.46	3.32
24.0	18.0	4.04	3.81	3.60	3.54	3.47

MODEL: ARYG12LSLAP

Outdoor temperature		Indoor temperature (°CDB)				
		16.0	18.0	20.0	22.0	24.0
(°CDB)	(°CWB)	TC	TC	TC	TC	TC
-15.0	-16.0	3.53	3.36	3.22	3.16	3.09
-10.0	-11.0	3.94	3.76	3.63	3.56	3.48
-5.0	-7.0	4.38	4.20	4.05	3.98	3.92
0.0	-2.0	4.83	4.64	4.46	4.35	4.24
5.0	3.0	5.44	5.18	4.80	4.64	4.48
7.0	6.0	5.55	5.22	4.80	4.58	4.35
10.0	8.0	5.51	5.19	4.80	4.58	4.36
15.0	10.0	5.50	5.15	4.80	4.60	4.39
20.0	15.0	5.46	5.12	4.80	4.61	4.43
24.0	18.0	5.39	5.08	4.80	4.72	4.63

MODEL: ARYG14LSLAP

Outdoor temperature		Indoor temperature (°CDB)				
		16.0	18.0	20.0	22.0	24.0
(°CDB)	(°CWB)	TC	TC	TC	TC	TC
-15.0	-16.0	4.11	3.92	3.76	3.68	3.60
-10.0	-11.0	4.60	4.38	4.24	4.15	4.06
-5.0	-7.0	5.11	4.90	4.72	4.65	4.58
0.0	-2.0	5.63	5.42	5.20	5.07	4.95
5.0	3.0	6.35	6.05	5.60	5.41	5.23
7.0	6.0	6.48	6.09	5.60	5.34	5.08
10.0	8.0	6.43	6.05	5.60	5.34	5.08
15.0	10.0	6.42	6.01	5.60	5.36	5.12
20.0	15.0	6.37	5.97	5.60	5.38	5.16
24.0	18.0	6.29	5.93	5.60	5.50	5.40

MODEL: ARYG18LSLAP

Outdoor temperature		Indoor temperature (°CDB)				
		16.0	18.0	20.0	22.0	24.0
(°CDB)	(°CWB)	TC	TC	TC	TC	TC
-15.0	-16.0	5.29	5.04	4.83	4.73	4.63
-10.0	-11.0	5.91	5.64	5.45	5.34	5.22
-5.0	-7.0	6.57	6.30	6.07	5.98	5.89
0.0	-2.0	7.24	6.96	6.69	6.52	6.36
5.0	3.0	8.16	7.78	7.20	6.96	6.72
7.0	6.0	8.33	7.83	7.20	6.86	6.53
10.0	8.0	8.27	7.78	7.20	6.87	6.53
15.0	10.0	8.25	7.73	7.20	6.89	6.59
20.0	15.0	8.19	7.67	7.20	6.92	6.64
24.0	18.0	8.09	7.62	7.20	7.07	6.95

NOTES:

- TC: Total Capacity (kW)
- Values mentioned in the table are based on the following conditions:
 - Pipe length: 5 m, Height difference: 0 m [Outdoor unit—Indoor unit]

■ Slim duct type

MODEL: ARYG07LLTA

Outdoor temperature		Indoor temperature (°CDB)				
		16.0	18.0	20.0	22.0	24.0
(°CDB)	(°CWB)	TC	TC	TC	TC	TC
-15.0	-16.0	2.06	1.96	1.88	1.84	1.80
-10.0	-11.0	2.30	2.19	2.12	2.08	2.03
-5.0	-7.0	2.56	2.45	2.36	2.32	2.29
0.0	-2.0	2.82	2.71	2.60	2.54	2.47
5.0	3.0	3.17	3.02	2.80	2.71	2.61
7.0	6.0	3.24	3.05	2.80	2.67	2.54
10.0	8.0	3.21	3.02	2.80	2.67	2.54
15.0	10.0	3.21	3.00	2.80	2.68	2.56
20.0	15.0	3.19	2.98	2.80	2.69	2.58
24.0	18.0	3.15	2.96	2.80	2.75	2.70

MODEL: ARYG09LLTA

Outdoor temperature		Indoor temperature (°CDB)				
		16.0	18.0	20.0	22.0	24.0
(°CDB)	(°CWB)	TC	TC	TC	TC	TC
-15.0	-16.0	2.64	2.52	2.42	2.37	2.32
-10.0	-11.0	2.96	2.82	2.73	2.67	2.61
-5.0	-7.0	3.29	3.15	3.03	2.99	2.94
0.0	-2.0	3.62	3.48	3.34	3.26	3.18
5.0	3.0	4.08	3.89	3.60	3.48	3.36
7.0	6.0	4.16	3.92	3.60	3.43	3.26
10.0	8.0	4.13	3.89	3.60	3.43	3.27
15.0	10.0	4.13	3.86	3.60	3.45	3.29
20.0	15.0	4.10	3.84	3.60	3.46	3.32
24.0	18.0	4.04	3.81	3.60	3.54	3.47

MODEL: ARYG12LLTB

Outdoor temperature		Indoor temperature (°CDB)				
		16.0	18.0	20.0	22.0	24.0
(°CDB)	(°CWB)	TC	TC	TC	TC	TC
-15.0	-16.0	3.53	3.36	3.22	3.16	3.09
-10.0	-11.0	3.94	3.76	3.63	3.56	3.48
-5.0	-7.0	4.38	4.20	4.05	3.98	3.92
0.0	-2.0	4.83	4.64	4.46	4.35	4.24
5.0	3.0	5.44	5.18	4.80	4.64	4.48
7.0	6.0	5.55	5.22	4.80	4.58	4.35
10.0	8.0	5.51	5.19	4.80	4.58	4.36
15.0	10.0	5.50	5.15	4.80	4.60	4.39
20.0	15.0	5.46	5.12	4.80	4.61	4.43
24.0	18.0	5.39	5.08	4.80	4.72	4.63

MODEL: ARYG14LLTB

Outdoor temperature		Indoor temperature (°CDB)				
		16.0	18.0	20.0	22.0	24.0
(°CDB)	(°CWB)	TC	TC	TC	TC	TC
-15.0	-16.0	4.11	3.92	3.76	3.68	3.60
-10.0	-11.0	4.60	4.38	4.24	4.15	4.06
-5.0	-7.0	5.11	4.90	4.72	4.65	4.58
0.0	-2.0	5.63	5.42	5.20	5.07	4.95
5.0	3.0	6.35	6.05	5.60	5.41	5.23
7.0	6.0	6.48	6.09	5.60	5.34	5.08
10.0	8.0	6.43	6.05	5.60	5.34	5.08
15.0	10.0	6.42	6.01	5.60	5.36	5.12
20.0	15.0	6.37	5.97	5.60	5.38	5.16
24.0	18.0	6.29	5.93	5.60	5.50	5.40

MODEL: ARYG18LLTB

Outdoor temperature		Indoor temperature (°CDB)				
		16.0	18.0	20.0	22.0	24.0
(°CDB)	(°CWB)	TC	TC	TC	TC	TC
-15.0	-16.0	5.29	5.04	4.83	4.73	4.63
-10.0	-11.0	5.91	5.64	5.45	5.34	5.22
-5.0	-7.0	6.57	6.30	6.07	5.98	5.89
0.0	-2.0	7.24	6.96	6.69	6.52	6.36
5.0	3.0	8.16	7.78	7.20	6.96	6.72
7.0	6.0	8.33	7.83	7.20	6.86	6.53
10.0	8.0	8.27	7.78	7.20	6.87	6.53
15.0	10.0	8.25	7.73	7.20	6.89	6.59
20.0	15.0	8.19	7.67	7.20	6.92	6.64
24.0	18.0	8.09	7.62	7.20	7.07	6.95

NOTES:

- TC: Total Capacity (kW)
- Values mentioned in the table are based on the following conditions:
 - Pipe length: 5 m, Height difference: 0 m (Outdoor unit—Indoor unit)

■ Wall mounted type

MODELS: ASYG07LMCA, ASYG07LMCE, and ASYG07LUCA

Outdoor temperature		Indoor temperature (°CDB)				
		16.0	18.0	20.0	22.0	24.0
(°CDB)	(°CWB)	TC	TC	TC	TC	TC
-15.0	-16.0	2.06	1.96	1.88	1.84	1.80
-10.0	-11.0	2.30	2.19	2.12	2.08	2.03
-5.0	-7.0	2.56	2.45	2.36	2.32	2.29
0.0	-2.0	2.82	2.71	2.60	2.54	2.47
5.0	3.0	3.17	3.02	2.80	2.71	2.61
7.0	6.0	3.24	3.05	2.80	2.67	2.54
10.0	8.0	3.21	3.02	2.80	2.67	2.54
15.0	10.0	3.21	3.00	2.80	2.68	2.56
20.0	15.0	3.19	2.98	2.80	2.69	2.58
24.0	18.0	3.15	2.96	2.80	2.75	2.70

OUTDOOR UNIT
AOYG36LBA5OUTDOOR UNIT
AOYG36LBA5

MODELS: ASYG09LMCA, ASYG09LMCE, and ASYG09LUCA

Outdoor temperature		Indoor temperature (°CDB)				
		16.0	18.0	20.0	22.0	24.0
(°CDB)	(°CWB)	TC	TC	TC	TC	TC
-15.0	-16.0	2.64	2.52	2.42	2.37	2.32
-10.0	-11.0	2.96	2.82	2.73	2.67	2.61
-5.0	-7.0	3.29	3.15	3.03	2.99	2.94
0.0	-2.0	3.62	3.48	3.34	3.26	3.18
5.0	3.0	4.08	3.89	3.60	3.48	3.36
7.0	6.0	4.16	3.92	3.60	3.43	3.26
10.0	8.0	4.13	3.89	3.60	3.43	3.27
15.0	10.0	4.13	3.86	3.60	3.45	3.29
20.0	15.0	4.10	3.84	3.60	3.46	3.32
24.0	18.0	4.04	3.81	3.60	3.54	3.47

MODELS: ASYG12LMCA, ASYG12LMCE, and ASYG12LUCA

Outdoor temperature		Indoor temperature (°CDB)				
		16.0	18.0	20.0	22.0	24.0
(°CDB)	(°CWB)	TC	TC	TC	TC	TC
-15.0	-16.0	3.53	3.36	3.22	3.16	3.09
-10.0	-11.0	3.94	3.76	3.63	3.56	3.48
-5.0	-7.0	4.38	4.20	4.05	3.98	3.92
0.0	-2.0	4.83	4.64	4.46	4.35	4.24
5.0	3.0	5.44	5.18	4.80	4.64	4.48
7.0	6.0	5.55	5.22	4.80	4.58	4.35
10.0	8.0	5.51	5.19	4.80	4.58	4.36
15.0	10.0	5.50	5.15	4.80	4.60	4.39
20.0	15.0	5.46	5.12	4.80	4.61	4.43
24.0	18.0	5.39	5.08	4.80	4.72	4.63

MODELS: ASYG14LMCA, ASYG14LMCE, and ASYG14LUCA

Outdoor temperature		Indoor temperature (°CDB)				
		16.0	18.0	20.0	22.0	24.0
(°CDB)	(°CWB)	TC	TC	TC	TC	TC
-15.0	-16.0	4.11	3.92	3.76	3.68	3.60
-10.0	-11.0	4.60	4.38	4.24	4.15	4.06
-5.0	-7.0	5.11	4.90	4.72	4.65	4.58
0.0	-2.0	5.63	5.42	5.20	5.07	4.95
5.0	3.0	6.35	6.05	5.60	5.41	5.23
7.0	6.0	6.48	6.09	5.60	5.34	5.08
10.0	8.0	6.43	6.05	5.60	5.34	5.08
15.0	10.0	6.42	6.01	5.60	5.36	5.12
20.0	15.0	6.37	5.97	5.60	5.38	5.16
24.0	18.0	6.29	5.93	5.60	5.50	5.40

MODEL: ASYG18LFCA

Outdoor temperature		Indoor temperature (°CDB)				
		16.0	18.0	20.0	22.0	24.0
(°CDB)	(°CWB)	TC	TC	TC	TC	TC
-15.0	-16.0	5.29	5.04	4.83	4.73	4.63
-10.0	-11.0	5.91	5.64	5.45	5.34	5.22
-5.0	-7.0	6.57	6.30	6.07	5.98	5.89
0.0	-2.0	7.24	6.96	6.69	6.52	6.36
5.0	3.0	8.16	7.78	7.20	6.96	6.72
7.0	6.0	8.33	7.83	7.20	6.86	6.53
10.0	8.0	8.27	7.78	7.20	6.87	6.53
15.0	10.0	8.25	7.73	7.20	6.89	6.59
20.0	15.0	8.19	7.67	7.20	6.92	6.64
24.0	18.0	8.09	7.62	7.20	7.07	6.95

MODELS: ASYG24LFCA and ASYG24LFCC

Outdoor temperature		Indoor temperature (°CDB)				
		16.0	18.0	20.0	22.0	24.0
(°CDB)	(°CWB)	TC	TC	TC	TC	TC
-15.0	-16.0	7.05	6.71	6.45	6.31	6.18
-10.0	-11.0	7.88	7.51	7.27	7.11	6.96
-5.0	-7.0	8.76	8.40	8.09	7.97	7.85
0.0	-2.0	9.65	9.28	8.91	8.70	8.48
5.0	3.0	10.88	10.37	9.60	9.28	8.96
7.0	6.0	11.10	10.44	9.60	9.15	8.70
10.0	8.0	11.02	10.37	9.60	9.16	8.71
15.0	10.0	11.00	10.30	9.60	9.19	8.78
20.0	15.0	10.92	10.23	9.60	9.23	8.85
24.0	18.0	10.79	10.16	9.60	9.43	9.26

NOTES:

- TC: Total Capacity (kW)
- Values mentioned in the table are based on the following conditions:
 - Pipe length: 5 m, Height difference: 0 m (Outdoor unit—Indoor unit)

■ Floor/Ceiling type

MODEL: ABYG14LVTA

Outdoor temperature		Indoor temperature (°CDB)				
		16.0	18.0	20.0	22.0	24.0
(°CDB)	(°CWB)	TC	TC	TC	TC	TC
-15.0	-16.0	4.11	3.92	3.76	3.68	3.60
-10.0	-11.0	4.60	4.38	4.24	4.15	4.06
-5.0	-7.0	5.11	4.90	4.72	4.65	4.58
0.0	-2.0	5.63	5.42	5.20	5.07	4.95
5.0	3.0	6.35	6.05	5.60	5.41	5.23
7.0	6.0	6.48	6.09	5.60	5.34	5.08
10.0	8.0	6.43	6.05	5.60	5.34	5.08
15.0	10.0	6.42	6.01	5.60	5.36	5.12
20.0	15.0	6.37	5.97	5.60	5.38	5.16
24.0	18.0	6.29	5.93	5.60	5.50	5.40

MODEL: ABYG18LVTB

Outdoor temperature		Indoor temperature (°CDB)				
		16.0	18.0	20.0	22.0	24.0
(°CDB)	(°CWB)	TC	TC	TC	TC	TC
-15.0	-16.0	5.29	5.04	4.83	4.73	4.63
-10.0	-11.0	5.91	5.64	5.45	5.34	5.22
-5.0	-7.0	6.57	6.30	6.07	5.98	5.89
0.0	-2.0	7.24	6.96	6.69	6.52	6.36
5.0	3.0	8.16	7.78	7.20	6.96	6.72
7.0	6.0	8.33	7.83	7.20	6.86	6.53
10.0	8.0	8.27	7.78	7.20	6.87	6.53
15.0	10.0	8.25	7.73	7.20	6.89	6.59
20.0	15.0	8.19	7.67	7.20	6.92	6.64
24.0	18.0	8.09	7.62	7.20	7.07	6.95

NOTES:

- TC: Total Capacity (kW)
- Values mentioned in the table are based on the following conditions:
 - Pipe length: 5 m, Height difference: 0 m (Outdoor unit—Indoor unit)

■ Floor type

MODEL: AGYG09LVCA

Outdoor temperature		Indoor temperature (°CDB)				
		16.0	18.0	20.0	22.0	24.0
(°CDB)	(°CWB)	TC	TC	TC	TC	TC
-15.0	-16.0	2.64	2.52	2.42	2.37	2.32
-10.0	-11.0	2.96	2.82	2.73	2.67	2.61
-5.0	-7.0	3.29	3.15	3.03	2.99	2.94
0.0	-2.0	3.62	3.48	3.34	3.26	3.18
5.0	3.0	4.08	3.89	3.60	3.48	3.36
7.0	6.0	4.16	3.92	3.60	3.43	3.26
10.0	8.0	4.13	3.89	3.60	3.43	3.27
15.0	10.0	4.13	3.86	3.60	3.45	3.29
20.0	15.0	4.10	3.84	3.60	3.46	3.32
24.0	18.0	4.04	3.81	3.60	3.54	3.47

MODEL: AGYG12LVCA

Outdoor temperature		Indoor temperature (°CDB)				
		16.0	18.0	20.0	22.0	24.0
(°CDB)	(°CWB)	TC	TC	TC	TC	TC
-15.0	-16.0	3.53	3.36	3.22	3.16	3.09
-10.0	-11.0	3.94	3.76	3.63	3.56	3.48
-5.0	-7.0	4.38	4.20	4.05	3.98	3.92
0.0	-2.0	4.83	4.64	4.46	4.35	4.24
5.0	3.0	5.44	5.18	4.80	4.64	4.48
7.0	6.0	5.55	5.22	4.80	4.58	4.35
10.0	8.0	5.51	5.19	4.80	4.58	4.36
15.0	10.0	5.50	5.15	4.80	4.60	4.39
20.0	15.0	5.46	5.12	4.80	4.61	4.43
24.0	18.0	5.39	5.08	4.80	4.72	4.63

MODEL: AGYG14LVCA

Outdoor temperature		Indoor temperature (°CDB)				
		16.0	18.0	20.0	22.0	24.0
(°CDB)	(°CWB)	TC	TC	TC	TC	TC
-15.0	-16.0	4.11	3.92	3.76	3.68	3.60
-10.0	-11.0	4.60	4.38	4.24	4.15	4.06
-5.0	-7.0	5.11	4.90	4.72	4.65	4.58
0.0	-2.0	5.63	5.42	5.20	5.07	4.95
5.0	3.0	6.35	6.05	5.60	5.41	5.23
7.0	6.0	6.48	6.09	5.60	5.34	5.08
10.0	8.0	6.43	6.05	5.60	5.34	5.08
15.0	10.0	6.42	6.01	5.60	5.36	5.12
20.0	15.0	6.37	5.97	5.60	5.38	5.16
24.0	18.0	6.29	5.93	5.60	5.50	5.40

NOTES:

- TC: Total Capacity (kW)
- Values mentioned in the table are based on the following conditions:
 - Pipe length: 5 m, Height difference: 0 m [Outdoor unit—Indoor unit]

7. Capacity compensation rate for pipe length and height difference

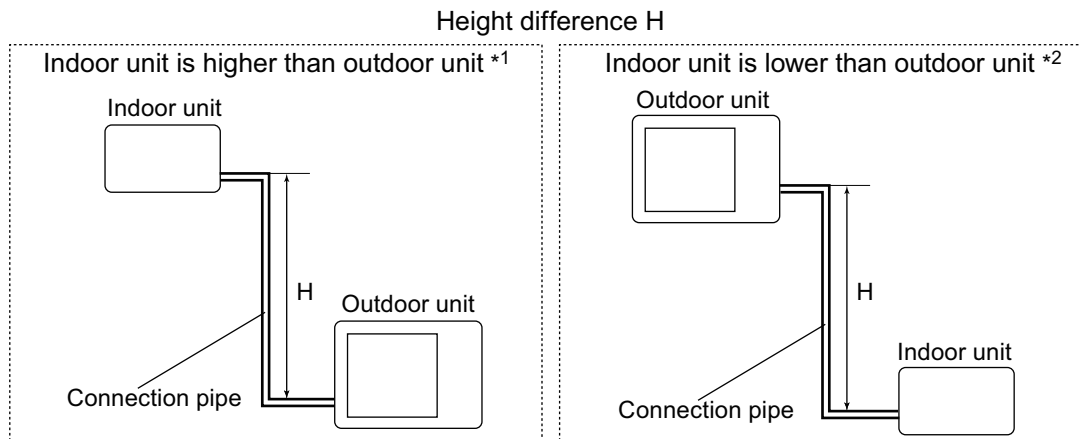

OUTDOOR UNIT
AOYG36LBLA5

OUTDOOR UNIT
AOYG36LBLA5

7-1. Model: AOYG36LBLA5

NOTE: Values mentioned in the table are calculated based on the maximum capacity.

■ Indoor unit: 7,000 Btu

COOLING		Pipe length						
		m	5	7.5	10	15	20	25
Height difference H (m)	Indoor unit is higher than outdoor unit *1	15	—	—	—	0.955	0.941	0.927
		10	—	—	0.976	0.962	0.949	0.935
		7.5	—	0.988	0.980	0.966	0.952	0.939
		5	0.992	0.992	0.984	0.970	0.956	0.942
		0	1.000	1.000	0.992	0.978	0.964	0.950
	Indoor unit is lower than outdoor unit *2	-5	1.000	1.000	0.992	0.978	0.964	0.950
		-7.5	—	1.000	0.992	0.978	0.964	0.950
		-10	—	—	0.992	0.978	0.964	0.950
		-15	—	—	—	0.978	0.964	0.950

HEATING		Pipe length						
		m	5	7.5	10	15	20	25
Height difference H (m)	Indoor unit is higher than outdoor unit *1	15	—	—	—	0.976	0.957	0.938
		10	—	—	0.991	0.976	0.957	0.938
		7.5	—	1.000	0.991	0.976	0.957	0.938
		5	1.000	1.000	0.991	0.976	0.957	0.938
		0	1.000	1.000	0.991	0.976	0.957	0.938
	Indoor unit is lower than outdoor unit *2	-5	0.995	0.995	0.986	0.971	0.952	0.933
		-7.5	—	0.993	0.984	0.969	0.950	0.931
		-10	—	—	0.981	0.966	0.947	0.929
		-15	—	—	—	0.961	0.943	0.924

Indoor unit: 9,000 Btu

COOLING		Pipe length						
		m	5	7.5	10	15	20	25
Height difference H (m)	Indoor unit is higher than outdoor unit *1	15	—	—	—	0.956	0.942	0.928
		10	—	—	0.977	0.963	0.950	0.936
		7.5	—	0.988	0.981	0.967	0.954	0.940
		5	0.992	0.992	0.985	0.971	0.957	0.943
		0	1.000	1.000	0.993	0.979	0.965	0.951
	Indoor unit is lower than outdoor unit *2	-5	1.000	1.000	0.993	0.979	0.965	0.951
		-7.5	—	1.000	0.993	0.979	0.965	0.951
		-10	—	—	0.993	0.979	0.965	0.951
		-15	—	—	—	0.979	0.965	0.951

HEATING		Pipe length						
		m	5	7.5	10	15	20	25
Height difference H (m)	Indoor unit is higher than outdoor unit *1	15	—	—	—	0.977	0.958	0.939
		10	—	—	0.993	0.977	0.958	0.939
		7.5	—	1.000	0.993	0.977	0.958	0.939
		5	1.000	1.000	0.993	0.977	0.958	0.939
		0	1.000	1.000	0.993	0.977	0.958	0.939
	Indoor unit is lower than outdoor unit *2	-5	0.995	0.995	0.988	0.972	0.954	0.934
		-7.5	—	0.993	0.986	0.970	0.952	0.932
		-10	—	—	0.983	0.967	0.949	0.930
		-15	—	—	—	0.962	0.944	0.925

Indoor unit: 12,000 Btu

COOLING		Pipe length						
		m	5	7.5	10	15	20	25
Height difference H (m)	Indoor unit is higher than outdoor unit *1	15	—	—	—	0.937	0.912	0.888
		10	—	—	0.970	0.944	0.919	0.896
		7.5	—	0.988	0.974	0.948	0.923	0.899
		5	0.992	0.992	0.978	0.952	0.927	0.903
		0	1.000	1.000	0.986	0.960	0.934	0.910
	Indoor unit is lower than outdoor unit *2	-5	1.000	1.000	0.986	0.960	0.934	0.910
		-7.5	—	1.000	0.986	0.960	0.934	0.910
		-10	—	—	0.986	0.960	0.934	0.910
		-15	—	—	—	0.960	0.934	0.910

HEATING		Pipe length						
		m	5	7.5	10	15	20	25
Height difference H (m)	Indoor unit is higher than outdoor unit *1	15	—	—	—	0.977	0.958	0.938
		10	—	—	0.993	0.977	0.958	0.938
		7.5	—	1.000	0.993	0.977	0.958	0.938
		5	1.000	1.000	0.993	0.977	0.958	0.938
		0	1.000	1.000	0.993	0.977	0.958	0.938
	Indoor unit is lower than outdoor unit *2	-5	0.995	0.995	0.988	0.972	0.953	0.933
		-7.5	—	0.993	0.986	0.970	0.952	0.932
		-10	—	—	0.983	0.967	0.949	0.929
		-15	—	—	—	0.962	0.944	0.924

■ Indoor unit: 14,000 Btu

COOLING		Pipe length						
		m	5	7.5	10	15	20	25
Height difference H (m)	Indoor unit is higher than outdoor unit *1	15	—	—	—	0.955	0.937	0.922
		10	—	—	0.974	0.962	0.945	0.930
		7.5	—	0.988	0.978	0.966	0.948	0.934
		5	0.992	0.992	0.982	0.970	0.952	0.937
	Indoor unit is lower than outdoor unit *2	0	1.000	1.000	0.990	0.978	0.960	0.945
		-5	1.000	1.000	0.990	0.978	0.960	0.945
		-7.5	—	1.000	0.990	0.978	0.960	0.945
		-10	—	—	0.990	0.978	0.960	0.945
		-15	—	—	—	0.978	0.960	0.945

HEATING		Pipe length						
		m	5	7.5	10	15	20	25
Height difference H (m)	Indoor unit is higher than outdoor unit *1	15	—	—	—	0.972	0.945	0.919
		10	—	—	0.992	0.972	0.945	0.919
		7.5	—	1.000	0.992	0.972	0.945	0.919
		5	1.000	1.000	0.992	0.972	0.945	0.919
	Indoor unit is lower than outdoor unit *2	0	1.000	1.000	0.992	0.972	0.945	0.919
		-5	0.995	0.995	0.987	0.967	0.940	0.914
		-7.5	—	0.993	0.985	0.965	0.938	0.912
		-10	—	—	0.982	0.962	0.935	0.910
		-15	—	—	—	0.957	0.930	0.905

■ Indoor unit: 18,000 Btu

COOLING		Pipe length						
		m	5	7.5	10	15	20	25
Height difference H (m)	Indoor unit is higher than outdoor unit *1	15	—	—	—	0.968	0.961	0.954
		10	—	—	0.982	0.976	0.969	0.962
		7.5	—	0.988	0.986	0.980	0.973	0.966
		5	0.992	0.992	0.990	0.984	0.977	0.970
	Indoor unit is lower than outdoor unit *2	0	1.000	1.000	0.998	0.992	0.985	0.978
		-5	1.000	1.000	0.998	0.992	0.985	0.978
		-7.5	—	1.000	0.998	0.992	0.985	0.978
		-10	—	—	0.998	0.992	0.985	0.978
		-15	—	—	—	0.992	0.985	0.978

HEATING		Pipe length						
		m	5	7.5	10	15	20	25
Height difference H (m)	Indoor unit is higher than outdoor unit *1	15	—	—	—	0.967	0.943	0.917
		10	—	—	0.990	0.967	0.943	0.917
		7.5	—	1.000	0.990	0.967	0.943	0.917
		5	1.000	1.000	0.990	0.967	0.943	0.917
	Indoor unit is lower than outdoor unit *2	0	1.000	1.000	0.990	0.967	0.943	0.917
		-5	0.995	0.995	0.985	0.962	0.938	0.912
		-7.5	—	0.993	0.983	0.960	0.936	0.910
		-10	—	—	0.980	0.958	0.933	0.908
		-15	—	—	—	0.953	0.929	0.903

■ Indoor unit: 24,000 Btu

COOLING		Pipe length						
		m	5	7.5	10	15	20	25
Height difference H (m)	Indoor unit is higher than outdoor unit *1	15	—	—	—	0.978	0.969	0.953
		10	—	—	0.986	0.986	0.977	0.961
		7.5	—	0.988	0.990	0.990	0.981	0.965
		5	0.992	0.992	0.994	0.994	0.984	0.968
	Indoor unit is lower than outdoor unit *2	0	1.000	1.000	1.002	1.002	0.992	0.976
		-5	1.000	1.000	1.002	1.002	0.992	0.976
		-7.5	—	1.000	1.002	1.002	0.992	0.976
		-10	—	—	1.002	1.002	0.992	0.976
		-15	—	—	—	1.002	0.992	0.976

HEATING		Pipe length						
		m	5	7.5	10	15	20	25
Height difference H (m)	Indoor unit is higher than outdoor unit *1	15	—	—	—	0.964	0.939	0.913
		10	—	—	0.988	0.964	0.939	0.913
		7.5	—	1.000	0.988	0.964	0.939	0.913
		5	1.000	1.000	0.988	0.964	0.939	0.913
	Indoor unit is lower than outdoor unit *2	0	1.000	1.000	0.988	0.964	0.939	0.913
		-5	0.995	0.995	0.983	0.959	0.934	0.909
		-7.5	—	0.993	0.981	0.957	0.932	0.907
		-10	—	—	0.978	0.954	0.929	0.904
		-15	—	—	—	0.949	0.925	0.899

8. Additional charge calculation

8-1. Model: AOYG36LBLA5

Refrigerant type				R410A
Refrigerant amount	g	4,000		

■ Refrigerant charge

Total pipe length	m	50 or less	60	70	80 (Max.)	20 g/m
Additional charge	g	0	200	400	600	

9. Airflow

9-1. Model: AOYG36LBLA5

● Cooling

m ³ /h	4,200
l/s	1,167
CFM	2,472

● Heating

m ³ /h	4,200
l/s	1,167
CFM	2,472

10. Operation noise (sound pressure)

10-1. Noise level curve

Model: AOYG36LBLA5

● Cooling

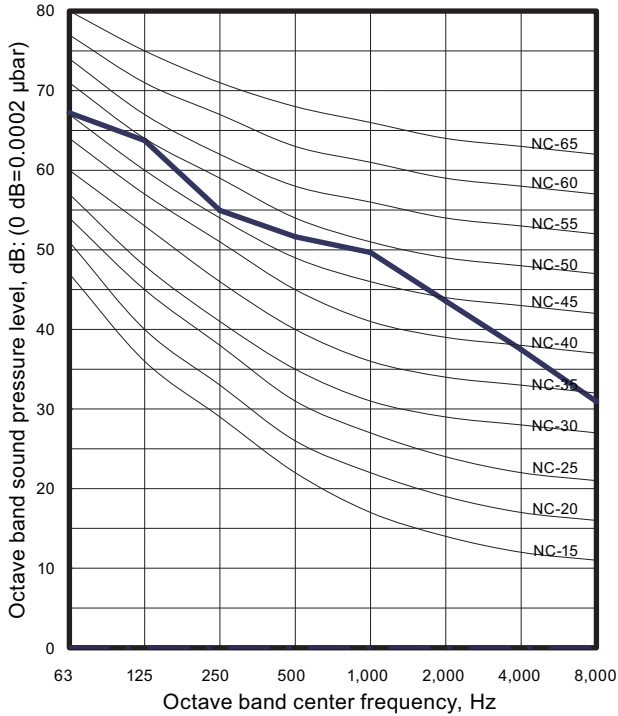

● Heating

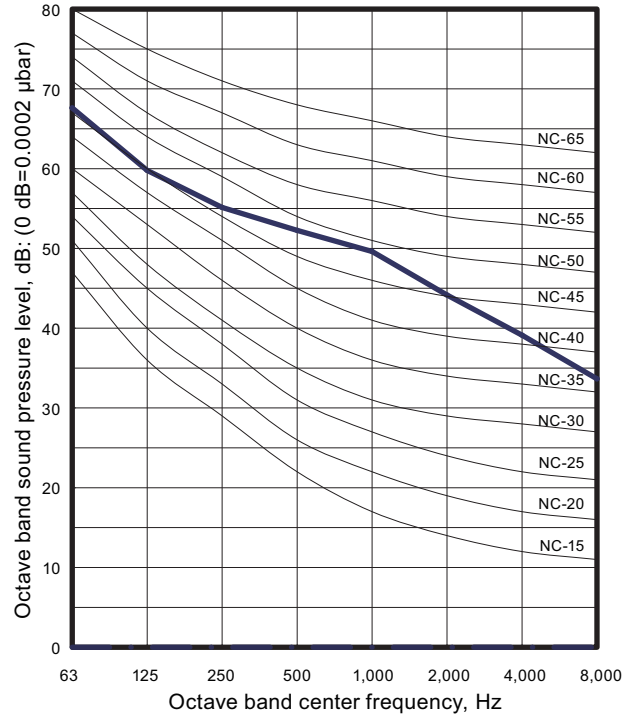

10-2. Sound level check point

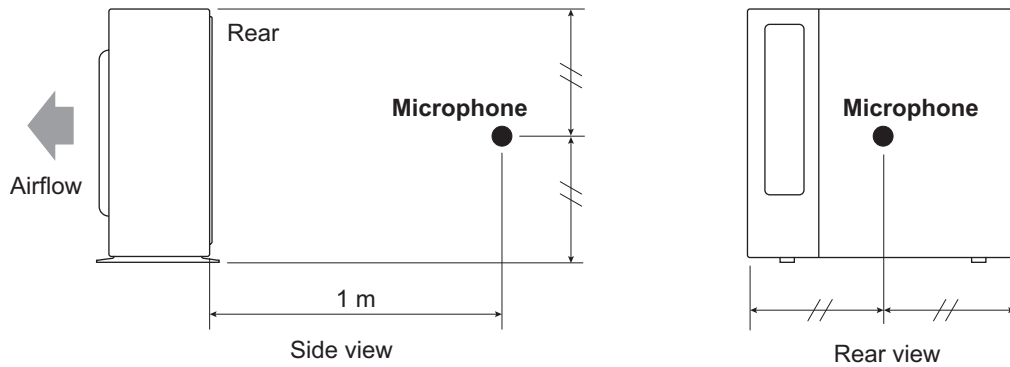

NOTE: Detailed shape of the actual outdoor unit might be slightly different from the one illustrated above.

OUTDOOR UNIT
AOYG36LBLA5

OUTDOOR UNIT
AOYG36LBLA5

11. Electrical characteristics

Model name			AOYG36LBLA5
Power supply	Voltage	V	230 ~
	Frequency	Hz	50
Maximum operating current		A	20.6
Starting current		A	12.3
Wiring spec. *	CKT. BKR	A	25
	Power cable	mm ²	6.0

*: Selected sample based on Japan Electrotechnical Standards and Codes Committee E0005. As the regulations of wire size and circuit breaker differ in each country or region, select appropriate devices complied to the regional standard.

CKT. BKR: Circuit Breaker

12. Safety devices

Type of protection	Protection form		Model
			AOYG36LBLA5
Circuit protection	Current fuse (PCB)		250 V, 10 A 250 V, 5 A 400 V, 5 A 250 V, 3.15 A
	Protector (PCB)		500 V, 45 A
Fan motor protection	Thermal protection program		Activate 115±15 °C Fan motor stop
			Reset 70 °C Fan motor restart
Compressor protection	Thermal protection program (Compressor temp.)		Activate 108 °C Compressor stop
			Reset 80 °C Compressor restart
	Thermal protection program (Discharge temp.)		Activate 110 °C Compressor stop
			Reset After 3 minutes and 110 °C less than Compressor restart

13. Function settings

13-1. Setting methods

⚠ WARNING

Never touch electrical components such as the terminal blocks or reactor except the switch on the display board. It may cause a serious accident such as electric shock.

⚠ CAUTION

- Once refrigerant charging is completed, be sure to open the valve prior to performing the local settings. Otherwise, the compressor may fail.
- Discharge any static electricity from your body before touching the push switches. Never touch any terminal or pattern of any parts on the control board.

The positions of the switches on the outdoor unit control board are shown in the figure below.

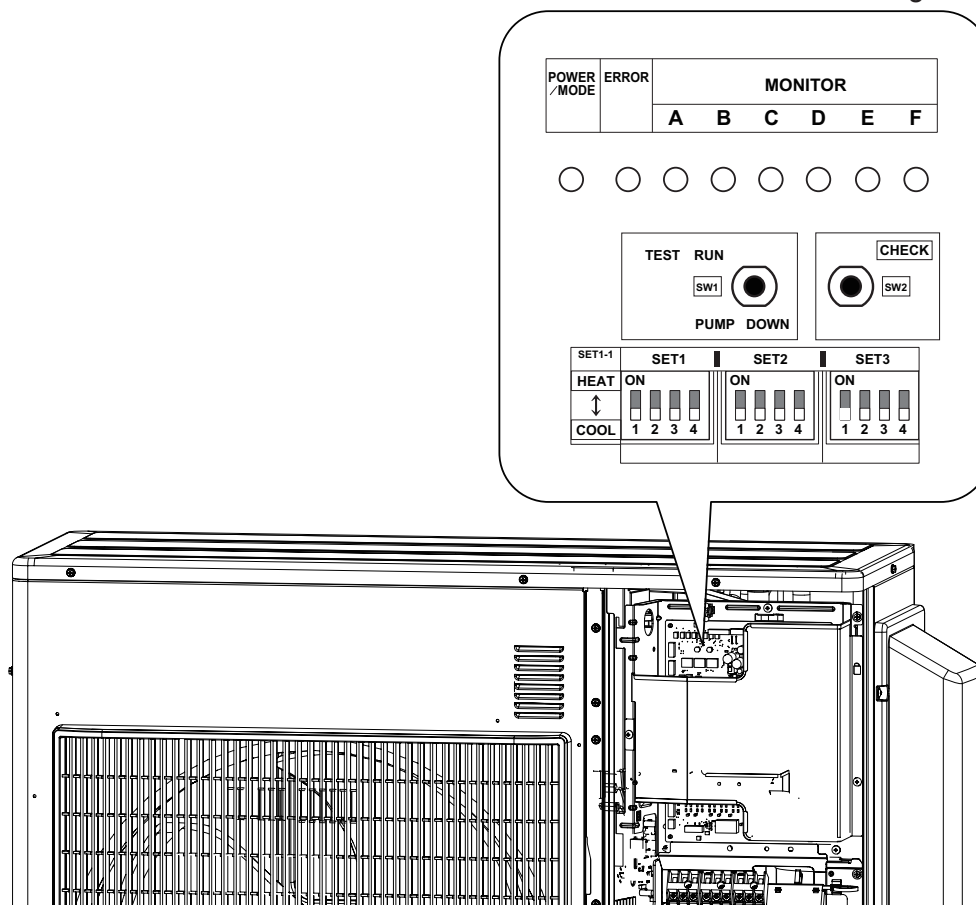

■ Setting method

1. Be sure to disconnect the power supply or turn off the breaker.
2. Change the DIP switch setting according to the required setting.
 - Various settings can be adjusted by changing DIP switches and push switches on the board of the outdoor unit.
 - The printed characters for the LED display are shown below.

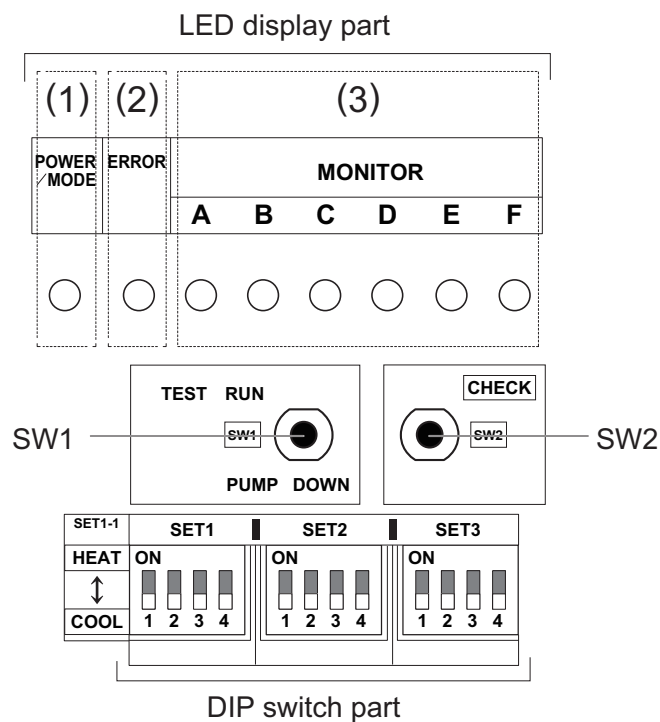

■ Description of display

LED display lamp			Function or operation method
(1)	POWER/MODE	Green	<ul style="list-style-type: none"> Turns on when the power supply is ON (Including when error occurs). Indicate the MODE by the number of flashes when the installation function is active.
(2)	ERROR	Red	Flashes at high-speed when there is an error.
(3)	MONITOR	A	<ul style="list-style-type: none"> Displays the location and contents of errors when there is an error. (Refer to Chapter 14-3. "Error code" on page 336 for details.) Displays when check run is activated. (Refer to Chapter 14-1. "Check run" on page 329 for details.)
		B	
		C	
		D	
		E	
		F	

Switch		Function or operation method	Factory setting
SW1	Push	<ul style="list-style-type: none"> For the test run start and stop. For the pump down start and stop. 	—
SW2	Push	<ul style="list-style-type: none"> For when check run function is activated. For displaying the check run. For resetting the Automatic wiring correction memory. 	—
SET1-1	DIP	For selecting cooling or heating during test operation.	OFF
SET1-2	DIP	For switching SW1 operation.	OFF
SET1-3	DIP	(Prohibited)	OFF (Do not change)
SET1-4	DIP	(Prohibited)	OFF (Do not change)
SET2-1	DIP	<ul style="list-style-type: none"> For selecting outdoor unit low noise operation function. To use this function, the Central remote controller (option) is necessary. 	OFF
SET2-2	DIP	(Prohibited)	OFF (Do not change)
SET2-3	DIP	Changing the current limit	OFF
SET2-4	DIP		
SET3-1	DIP	(Prohibited)	OFF (Do not change)
SET3-2	DIP	(Prohibited)	OFF (Do not change)
SET3-3	DIP	(Prohibited)	OFF (Do not change)
SET3-4	DIP	(Prohibited)	OFF (Do not change)

Be sure to disconnect the power supply or turn off the breaker before changing the DIP switch setting.

13-2. Outdoor unit low noise operation function (option)

Change the outdoor unit low noise operation by using this setting. Optional Central remote controller is necessary to use this function.

SET2-1	Setting	Factory setting
ON	Lower	
OFF	Low	◆

⚠ CAUTION

- When the low noise operation function is working, cooling and heating capacity will decrease.
- When changing the settings, explain to the customer beforehand that the capacity decreases.

13-3. Changing the current limit function

Change the outdoor unit current limit function by using this setting.

SET2-3	SET2-4	Current	Factory setting
OFF	OFF	Full	◆
ON	OFF	20.5 A	
OFF	ON	16.5 A	

⚠ CAUTION

- When the current limited function is working, cooling and heating capacity will decrease.
- When changing the settings, explain to the customer beforehand that the capacity decreases.

14. Check and test

14-1. Check run

- The check run is a function to screen and detect any wiring errors.
- After carrying out the check run, you can use the automatic wiring correction function to correct the wiring.
- Normal operation is possible without using the check run. In this case, use the test run or forced cooling function of the indoor unit to confirm any wiring errors.

■ Things to confirm before starting the check run

To ensure safety, check that the following work, inspections and operations have been completed.

	Check item	Check column
1	Check that all work on the piping connecting the outdoor unit, indoor units has been completed.	
2	Check that all work on the wiring connecting the outdoor unit, indoor units has been completed.	
3	Is there a gas leakage? (At pipe connections [flange connections and brazed areas])	
4	Is the system charged with the specified volume of refrigerant?	
5	Is a breaker installed at the power supply cable of outdoor unit?	
6	Are the wires connected to the terminals without looseness, and in accordance with the specifications?	
7	Is the 3-way valve of the outdoor unit open? (Gas pipe and liquid pipe)	
8	Is the power supply connected for more than 12 hours?	

■ Restrictions applicable when performing the check run

- When the check run starts, all indoor units connected to the outdoor unit will start to run automatically. During the check run, you cannot check the operation of the indoor units separately. After the check run, check the operation of the indoor units separately in normal operation.
- The check run can be used when the temperature is within the operable temperature of the air conditioner.
- In the check run, the air conditioner will automatically switch between cooling and heating depending on the external temperature and internal temperature.
- The check run can be completed in about 30 minutes (cooling) or about 1 hour (heating), but may take more depending on the external and internal temperature conditions etc.
- Do not conduct the check run with all the windows in the room closed. Otherwise the room temperature could get too low or too high.
- Depending on the difference of the room temperature of each room, a judgment may be impossible.
- Check run is a special operation so there may be a noise louder than the normal refrigerant noise or a creaking noise.

■ Operating procedure for check run

⚠ CAUTION

Initiate check run after more than 12 hours after the power supply is connected.

NOTE: Be sure that the indoor unit and outdoor unit are not operating before starting the check run.

1. Press the "CHECK" switch for 3 seconds or more.

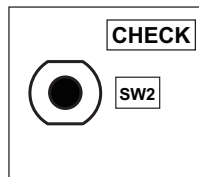

2. The number of indoor units (and the places) connected through the communication lines is displayed.
 - If the displayed number of units (places) and the installed number of units (places) is the same, proceed to step 3.
 - If the displayed number of units (places) and the installed number of units (places) is not the same, shut off the power and check whether the indoor and outdoor communication lines are properly connected.
 - If there is no operation for 1 minute, the LED will return to the original display. (POWER/MODE LED: ON)

Example: When 4 indoor units (A to D) are connected

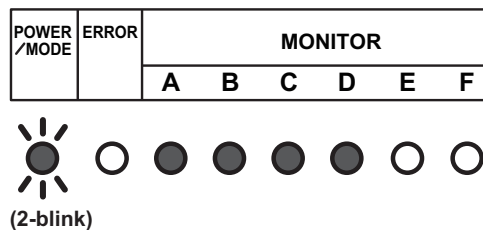

3. Press the "CHECK" switch for 3 seconds or more again. Check run is initiated.
 - When check run is initiated, all LEDs from A to F will flash. (Preliminary operation)
 - The LED for each indoor unit will switch off in order as check for each unit is completed.

NOTE: To interrupt the check run, press the "CHECK" switch.

Example: When 4 indoor units (A to D) are connected

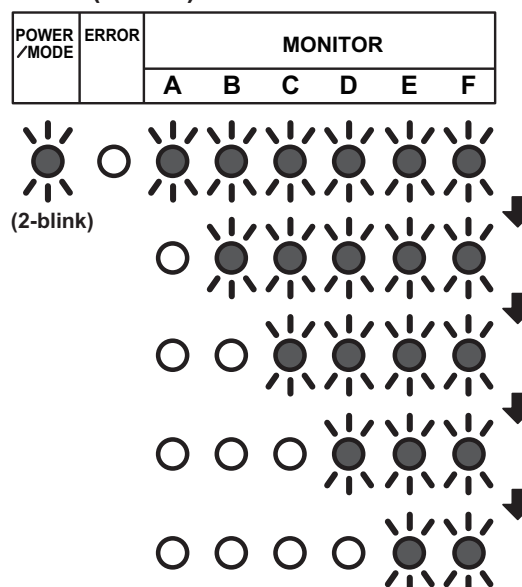

4. After the check run is completed, results will be displayed. Fill the displayed results in the result table accordingly.

• **If the connection is correct (Example: When 4 indoor units are connected)**

After the number of connected units are displayed, the LED for each unit will light up in order from A to D.

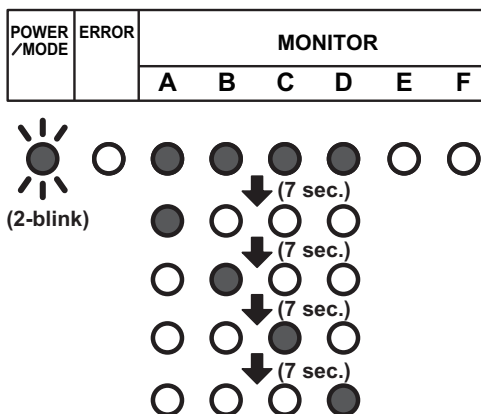

• **If the connection is incorrect (Example: When connection of B and C of the 4 units are reversed)**

After the number of connected units are displayed, B and C will light up in reverse.

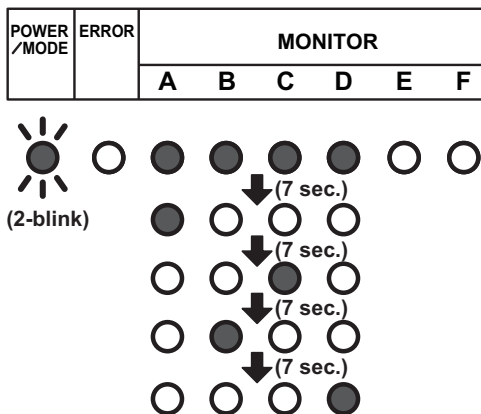

NOTES:

- Automatic wiring correction will not be completed if the power supply is disconnected while displaying the results. To confirm the automatic wiring correction, be sure to carry out step 5.
- If frost is formed on the outdoor unit while displaying the results, automatic defrost function will be operated. Proceed to step 5 after the defrost function is finished.

[How to record the contents]

- Fill the displayed results according to the following example.

Example: When piping A to D is connected but the wires for B and C are connected in reverse.

<Displayed results>

The LEDs will light up in 7 second intervals in the following order.

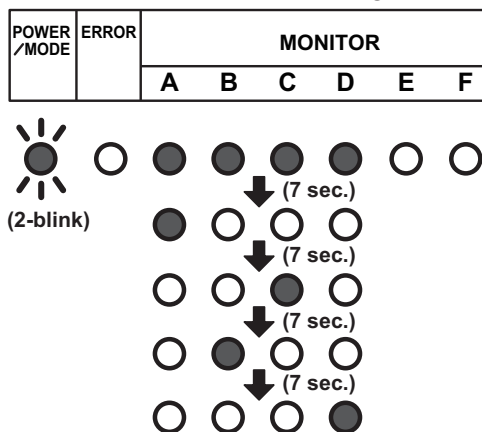

<Example of result table>

- a. Please write a ● where the LEDs light up in the order that they light up.

	A	B	C	D	E	F
1	●	●	●	●	○	○
2	●	○	○	○	○	○
3	○	○	●	○	○	○
4	○	●	○	○	○	○
5	○	○	○	●	○	○
6	○	○	○	○	○	○
7	○	○	○	○	○	○

- b. Based on the results of step (a), please record as follows.

- Trace the dotted circle with a pen if multiple places light up.

A	B	C	D	E	F
○	○	○	○	⊙	⊙

- Write the order from A to D in which the LEDs lit up inside the circle.

A	B	C	D	E	F
Ⓐ	Ⓒ	Ⓑ	Ⓓ	⊙	⊙

- c. Select the correction method.

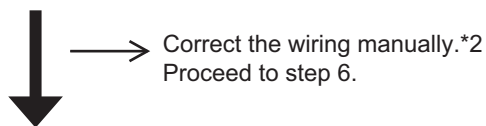

Use the Automatic wiring correction function.*1
Proceed to step 5.

Write down the same results in the label on the reverse side of the service panel.

The results recorded are needed at the time of servicing.

NOTES:

- *1: By using this function, the wiring is automatically corrected according to the piping.
- *2: When correcting the wiring manually, please disconnect the power supply or turn off the breaker during results display, and then change the wiring manually according to the obtained test results.

For example, in Example 1, the wirings connected to the terminals B and C is to be exchanged manually.

<Result Table>

	A	B	C	D	E	F
1	○	○	○	○	○	○
2	○	○	○	○	○	○
3	○	○	○	○	○	○
4	○	○	○	○	○	○
5	○	○	○	○	○	○
6	○	○	○	○	○	○
7	○	○	○	○	○	○

A	B	C	D	E	F
○	○	○	○	○	○

5. During results display, press the "CHECK" switch for 3 seconds or more. After LEDs A to F have lit in turn, all LEDs will light up indicating that the automatic wiring correction is completed.

POWER /MODE	ERROR	MONITOR					
		A	B	C	D	E	F



6. Disconnect the power supply or turn off the breaker and wait 10 minutes then turn the power back on and perform test run.

NOTE: If you do not disconnect the power supply or turn off the breaker, normal operation is not possible.

Notices:

- If an error occurs during check run it will be suspended. Correct the error and start check run again.
- After the check run, if automatic wiring correction is carried out, the indoor unit's position will be modified to match the piping. (Note that the display of the optional remote controller changes.)
- If you start check run again after the automatic wiring correction is finished, the modification will be reset.

■ Check run judgment failure display

If check run cannot be performed, the following is displayed. In this case, the check run will stop. Please check by using the cooling test run of the indoor unit.

● Temperature out of range judgment

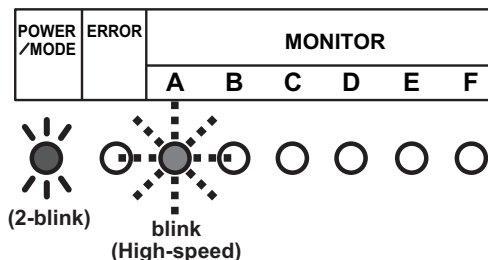

● Wiring/piping number difference

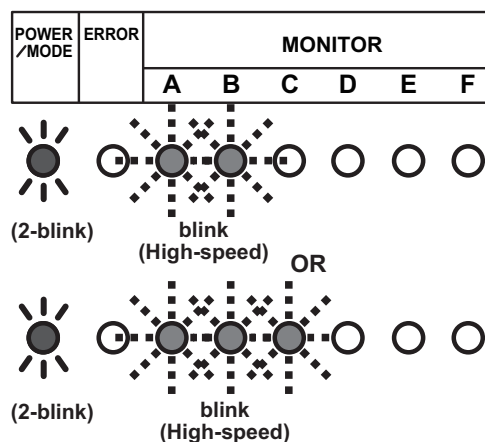

■ Re-display check run results

- If you wish to check the automatic wiring correction contents, by briefly pressing the "CHECK" switch, the check run results is displayed. Check the check run results by referring to the result table in step (4) of "Chapter 14-1-3. ["Operating procedure for check run"](#) on page 330".
- If the automatic wiring correction contents has not been done, the POWER/MODE LED will blink twice and the MONITOR LED will turn off.

■ Automatic wiring correction memory reset

⚠ CAUTION

When relocating the unit, reset the memory beforehand, or the unit may not function normally.

1. Press the "CHECK" switch.
The LED will light as shown in ["Re-display check run results"](#) on page 334".
2. Press the "CHECK" switch for more than 3 seconds when the LED is on.
3. The LEDs from A to F will light in sequence, and then all LEDs will light to indicate the completion of the Automatic wiring correction memory reset.
4. Disconnect the power supply or turn off the breaker.

14-2. Test run

⚠ CAUTION

Always connect the power supply 12 hours prior to the start of the operation in order to protect the compressor.

1. Indoor unit
 - a. Is the drain normal?
 - b. Is there any abnormal noise and vibration during operation?
 2. Outdoor unit
 - a. Is there any abnormal noise and vibration during operation?
 - b. Will noise, wind, or drain water from the unit disturb the neighbors?
 - c. Is there any gas leakage?
- Do not operate the air conditioner in the test running state for a long time.
 - For the operation method of the test run for indoor unit and central remote controller, refer to the operating manual and perform operation check.

■ Test run method

Be sure to temporarily disconnect the power supply or turn off the breaker before changing the DIP switch settings.

1. Check the 3-way valves (both at the liquid side and gas side) are opened. Confirm that the DIP switch SET1-2 is switched off.
2. Set the operation mode to "COOL" or "HEAT". When switching the DIP switch SET1-1 between HEAT and COOL, disconnect the power supply or turn off the circuit breaker beforehand.

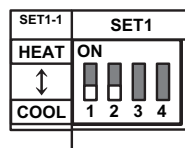

- In the first test run, be sure to set the operation mode to "COOL".
 - The operation mode cannot be switched between "COOL" and "HEAT" during the test run. To switch the operation mode between "COOL" and "HEAT", stop the test run, switch the operation mode, and then start the test run again.
3. Press "TEST RUN" switch for more than 3 seconds.
The POWER / MODE LED flashes once.

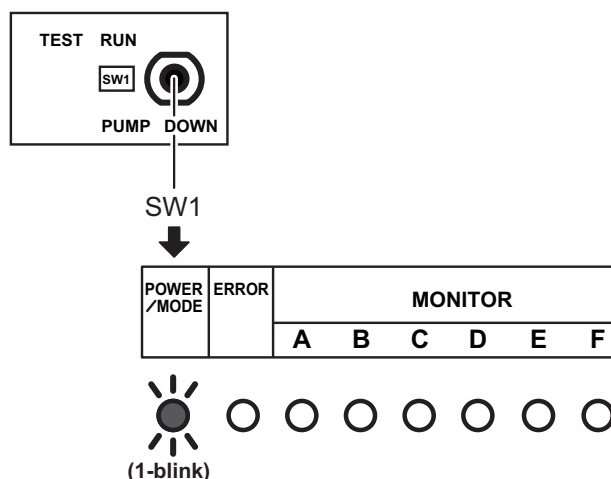

4. Confirm operating status.

5. Press "TEST RUN" switch for more than 3 seconds.

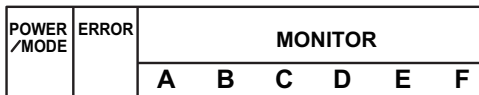

14-3. Error code

If an error occurs, the LED will light up to display the error location and the error code.

■ In the event of an error

The error LED blink quickly.

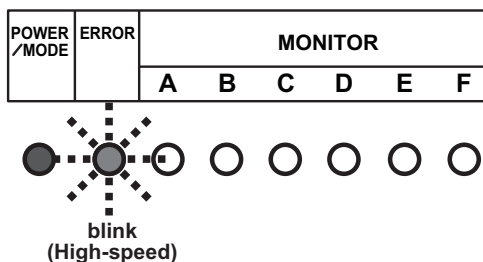

■ Error location display

LEDs A to F of MONITOR light up and display the error location. In the case of an overall error, LEDs A to F of MONITOR do not light up.

Example: Coil error in indoor unit B

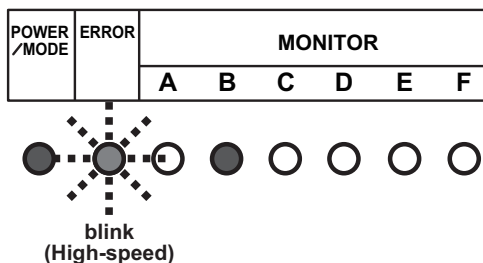

■ Error code display

While the error is occurring, briefly press SW1. The error code is displayed.

Example: Coil error (Error cord = 9A.1)

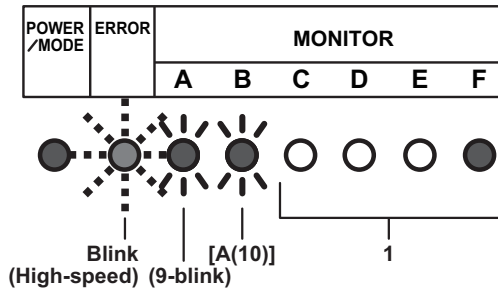

Display mode

LED on: ●

LED off: ○

Blink: 
(0.5s Light on / 0.5s Light off)

Number of blinking: ()

For MONITOR (A and B)

- A: 10-Blink
- C: 11-Blink
- F: 12-Blink
- J: 13-Blink
- P: 14-Blink
- U: 15-Blink

C	D	E	F	
○	○	○	●	➔ 1
○	○	●	○	➔ 2
○	○	●	●	➔ 3
○	●	○	○	➔ 4
○	●	○	●	➔ 5
○	●	●	○	➔ 6
○	●	●	●	➔ 7
●	○	○	○	➔ 8
●	○	○	●	➔ 9
●	○	●	○	➔ A
●	○	●	●	➔ C
●	●	○	○	➔ F
●	●	○	●	➔ J
●	●	●	○	➔ P
●	●	●	●	➔ U

Error code	Error type
11.3	Serial communication error
11.4	Serial communication error during operation
16.5	Communication error between controller and outdoor unit
22.1	Indoor unit capacity error
5U.1	Indoor unit error
62.1	PCB model information error
62.3	EEPROM access error
62.8	EEPROM data corruption error
63.1	Inverter error
65.3	IPM error (Trip terminal L error)
71.1	Discharge temp. sensor error
72.1	Compressor temp. sensor error
73.2	Heat exchanger middle temp. sensor error
73.3	Heat exchanger liquid temp. sensor error
74.1	Outdoor temp. sensor error
75.1	Suction gas temp. sensor error
76.1	Valve sensor error
76.2	
77.1	Heat sink temp. sensor error
84.1	Current sensor 1 error (stoppage permanently)
86.1	Discharge pressure sensor error
94.1	Trip detection
95.1	Compressor motor control error (stoppage permanently)
97.3	Fan motor 1 error (Duty error)
98.3	Fan motor 2 error (Duty error)
99.1	4-way valve error
9A.1	Coil 1 (expansion valve 1) error
A1.1	Discharge temperature 1 error (stoppage permanently)
A3.1	Compressor 1 temperature error

14-4. Pump down

⚠ WARNING

During the pump down operation, make sure that compressor is off before you remove the refrigerant piping. Do not remove the connection pipe while the compressor is in operation with valve open. This may cause abnormal pressure in the refrigeration cycle that leads to breakage and even injury.

■ Pump down operation

When moving or discarding the air conditioner, in order to consider the environment and avoid the discharge of refrigerant to the atmosphere, pump down according to the following procedure.

1. Connect the pressure gauge to the charging port.
2. Change the DIP switch on the board (SET1-2) to On*1
*Be sure the power supply is disconnected on the breaker is turned off when changing the DIP switch.

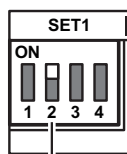

*1: DIP switch (SET1-2)

3. To start operation, press the [PUMP DOWN] switch*2 for 3 seconds or press after the power has been on for 3 min.

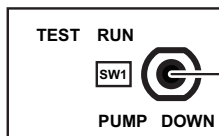

*2: Push switch (SW1)

During pump down, the LED (POWER/MODE) will flash 3 times consecutively.

POWER /MODE	ERROR	MONITOR					
		A	B	C	D	E	F



NOTE: If the [PUMP DOWN] switch is pressed during compressor operation, the compressor will stop, and the operation will start after about 3 min.

4. Close the liquid pipe valve.
5. When the value between 7.3 psi and 0 psi (0.05 Mpa to 0 Mpa) is shown, close the gas pipe valve.
6. Stop pump down by pressing the [PUMP DOWN] switch for 3 seconds.
The LED will light as follows.

POWER /MODE	ERROR	MONITOR					
		A	B	C	D	E	F







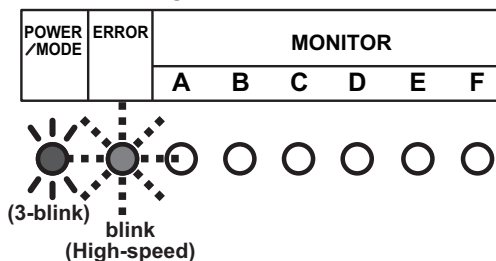



7. Disconnect the power supply or turn off the breaker.

NOTE: If the pump down is not stopped by pressing the switch as in step 6, it will stop automatically after 15 minutes and the LED will light as follows. If the pump down is complete, disconnect the power supply or turn off the breaker. If not completed open the liquid pipe valve, and then start again from step 3.

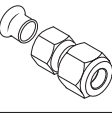

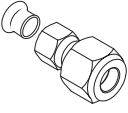
- In order to interrupt the pump down operation, press the [PUMP DOWN] switch again. The LED will return to the original display before starting pump down. (POWER/MODE LED: On)
- The pump down may stop before completion due to error. To complete the pump down, correct the error, open the liquid pipe valve and then start from step 1 again. Otherwise, the refrigerant can be recovered from the service port.

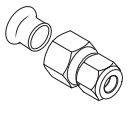
15. Accessories

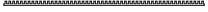
Part name	Exterior	Q'ty	Part name	Exterior	Q'ty
Installation manual		1	Drain cap		7
Drain pipe		1	Adapter K 12.70 mm (1/2 in) 9.52 mm (3/8 in)		2 set
Cable tie with clip (large)		2	Adapter L 12.70 mm (1/2 in) 15.88 mm (5/8 in)		2 set
Cable tie with clip (small)		2	Adapter H 9.52 mm (3/8 in) 12.70 mm (1/2 in)		1 set
Cable tie		1	Grommet edging		1

16. Optional parts

Exterior	Part name	Model name	Summary
	Central remote controller	UTY-DMMYM	<p>Set temperatures on timers to best meet individuals' needs. Includes a large backlit LCD and 4-way navigation pad.</p> <p>Remote controller cable: 0.33 mm² (22AWG)</p> <p>NOTE: The remote controller cable supplied with this controller is for indoor use. If you require cables for outdoor use, purchase locally. Material is not specified. However, it should be selected considering the installing environment (temperature, humidity), and regional regulations (RoHS Directive, etc.).</p>

17. Outdoor unit installation precautions

NOTE: The information listed below are general precautions.
Some models also include items that do not apply.

17-1. Places where prohibited for use

- Places where there is a danger of combustible gas leakage.
- Places where sulfur gas, chlorine gas, acid, alkali, or other matter which effects equipment is generated.
- Places not affected by heat radiation from other heat sources.
- Places where the air is not stagnant.
- Places where machinery which generates high frequencies is used.
- Ocean beaches and other areas where there is a lot of salt.
- Inside of vehicles, ships, and other conveyances.
- Places where voltage fluctuations are product.

17-2. Points to remember when installing

- The product shall be installed at a place which can withstand the weight and vibration of the outdoor unit.
- To allow maintenance after refrigerant piping, drain piping, and electric wiring connection and installation, provide an installation service space.
*Installation service space is shown in "[Installation space](#)" on page 277.
- Be careful when installing the set at the following places.

Condition	Contents	Countermeasures (Reference)
When installed near adjacent houses.	Perform installation work so that operating sound does not disturb the neighbors.	<ol style="list-style-type: none"> 1. Install a soundproof barrier. 2. Change the installation site.
When there is the possibility of strong wind.	<ul style="list-style-type: none"> • If the outdoor unit is exposed to strong wind, capacity may drop, frost may form during heating, and operation may be stopped by high pressure rise. In addition, when a very strong wind blows, the fan may be damaged. • When a very strong wind blows, there is the possibility of the outdoor unit being toppled over if held only by foundation bolts. 	<ol style="list-style-type: none"> 1. Install the outdoor unit with keeping a sufficient distance between the outlet side of the unit and a facing wall or fence. 2. Make the outlet direction and wind direction perpendicular. 3. Fasten the outdoor unit using toppling prevention hardware (purchased locally).
When snow accumulates.	If the outdoor unit is covered by accumulated snow, it may not be able to operate.	<ol style="list-style-type: none"> 1. Make the foundation as high as possible. 2. Perform snow prevention work.
When installing the inverter type.	It may generate noise in TV sets, stereos and PCs.	The inverter type should be installed at a sufficient distance from these equipments.

Part 3. OUTDOOR UNIT (6 ROOMS TYPE)

**MULTI TYPE:
AOYG45LBLA6**

1. Specifications

Type			Inverter heat pump		
Model name			AOYG45LBLA6		
Power supply			230 V ~ 50 Hz		
Available voltage range			198—264 V		
Standard combination of indoor unit			Wall mounted ASYG07LMCA × 5 ASYG09LMCA × 1		
Capacity	Cooling	Rated	kW	12.5	
			Btu/h	42,700	
		Min.—Max.	kW	3.5—14.0	
				Btu/h	11,900—47,800
	Heating	Rated	kW	13.5	
			Btu/h	46,100	
Min.—Max.		kW	3.5—16.0		
			Btu/h	11,900—54,600	
Input power	Cooling	Rated	kW	3.57	
		Max.		5.02	
	Heating	Rated		3.37	
		Max.		4.59	
Current	Cooling	Rated	A	15.7	
		Max.		24.0	
	Heating	Rated		14.9	
		Max.		24.0	
EER	Cooling	kW/kW		3.50	
COP	Heating			4.00	
Starting current			A	15.7	
Maximum operating current *1			A	24.0	
Fan	Airflow rate	Cooling	m ³ /h	4,200	
		Heating			
	Type × Q'ty	Propeller × 1			
	Motor output	W	111		
Sound pressure level*2		Cooling	dB (A)	53	
		Heating		55	
Heat exchanger type		Dimensions (H × W × D)	mm	966 × 922 × 55	
		Fin pitch		1.45	
		Rows × Stages	3 × 46		
		Pipe type	Copper		
		Fin type	Type (Material)	Corrugate (Aluminum)	
	Surface treatment	Corrosion resistance (Blue fin)			
Compressor	Type × Q'ty	DC twin rotary × 1			
	Motor output	W	2,100		
Refrigerant	Type	R410A			
	Charge	g	4,000		
Refrigerant oil	Type	RB68			
	Amount	cm ³	1,150		
Enclosure	Material	Steel sheet			
	Color	Beige (Approximate color of Munsell 10YR 7.5/1.0 NN)			
Dimensions (H × W × D)	Net	mm	998 × 970 × 370		
	Gross		1,162 × 1,150 × 478		
Weight	Net	kg	94		
	Gross		105		
Connection pipe	Size	Liquid	mm	∅ 6.35 (∅ 1/4) × 6	
		Gas		∅ 9.52 (∅ 3/8) × 4 + ∅ 12.70 (∅ 1/2) × 2	
	Method		Flare		
	Pre-charge length (Total)		50		
	Maximum length (Total)		80		
	Maximum length (Each)		25		
	Minimum length (Total)		15		
	Minimum length (Each)		5		
	Maximum height difference between outdoor unit and each indoor units.		15		
	Maximum height difference between indoor units.		10		
Operation range	Cooling	°C	-10 to 46		
	Heating		-15 to 24		

NOTES:

- Specifications are based on the following conditions:
 - Power source of specifications: 230 V
 - Pipe length: 5 m, Height difference: 0 m [Outdoor unit—Indoor unit]
 - Cooling: Indoor temperature of 27 °CDB/19 °CWB, and outdoor temperature of 35 °CDB/24 °CWB.
 - Heating: Indoor temperature of 20 °CDB/15 °CWB, and outdoor temperature of 7 °CDB/6 °CWB.
- *1: The maximum current is the maximum value when the operated within the operation range.
- *2: Sound pressure level
 - Measured values in manufacturer's anechoic chamber.
 - Because of the surrounding sound environment, the sound levels measured in actual installation conditions might be higher than the specified values here.
- *3: Connect to connection valve by the adapter.
- For other combination, refer to the combination table.
- The protective function might work when using it outside the operation range.

2. Dimensions

2-1. Model: AOYG45LBLA6

Unit: mm

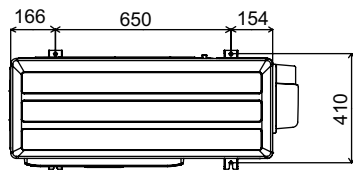

Top view

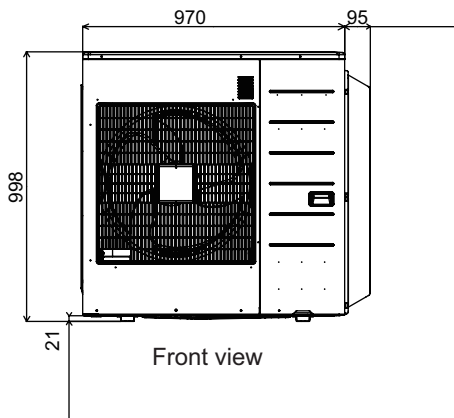
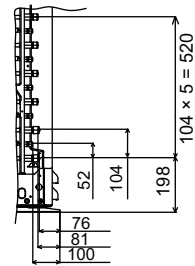

Front view

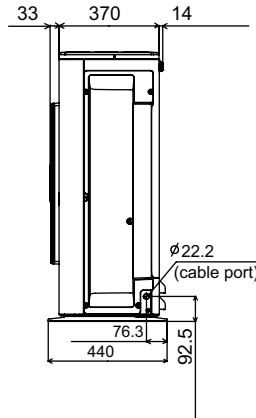

Side view

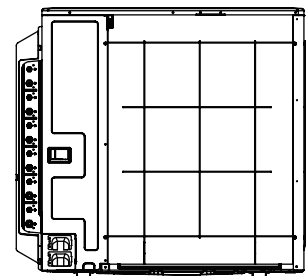

Rear view

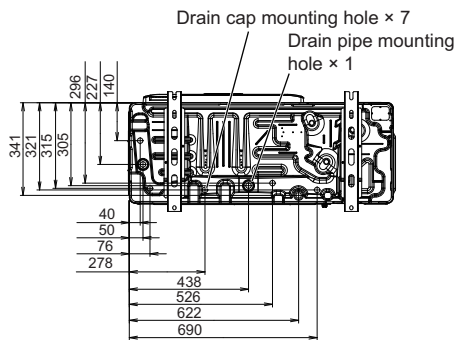

Bottom view

OUTDOOR UNIT
AOYG45LBLA6

OUTDOOR UNIT
AOYG45LBLA6

3. Installation space

3-1. Model: AOYG45LBLA6

■ Space requirement

Provide sufficient installation space for product safety.

● Single outdoor unit installation

- When the upper space is open:

Unit: mm

When there are obstacles at the rear only.

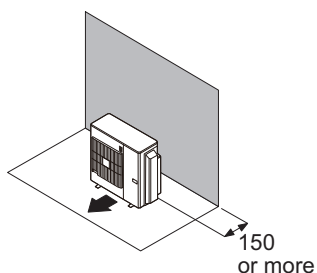

When there are obstacles at the rear and sides.

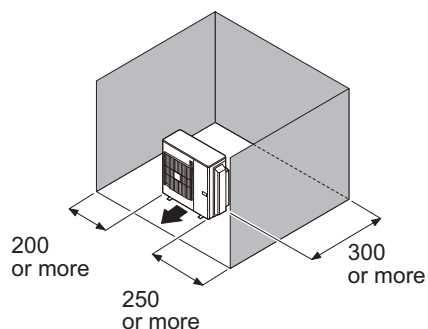

When there are obstacles at the front only.

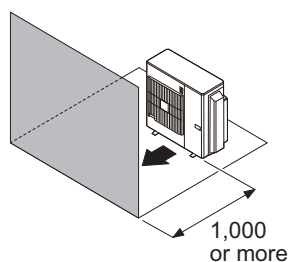

When there are obstacles at the front and rear.

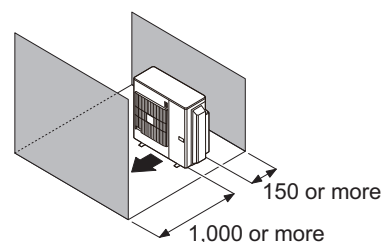

- When there is an obstruction in the upper space:

Unit: mm

When there are obstacles at the rear and above.

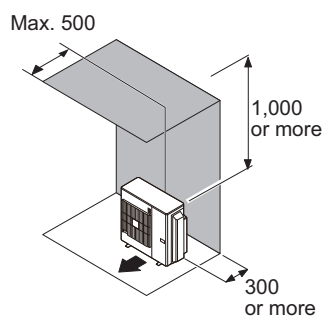

When there are obstacles at the rear, sides, and above.

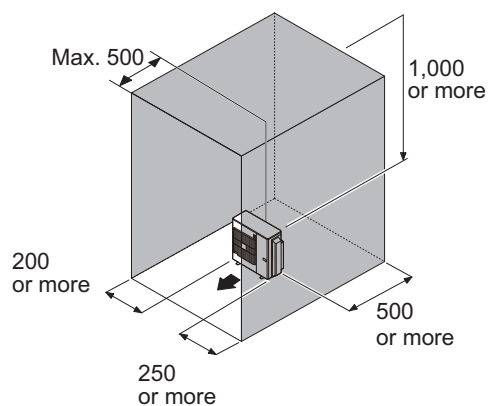

● Multiple outdoor unit installation

- When the upper space is open:

Unit: mm

When there are obstacles at the rear only.

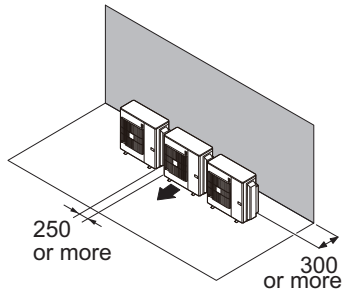

When there are obstacles at the front only.

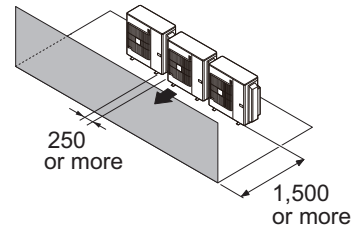

When there are obstacles at the front and rear.

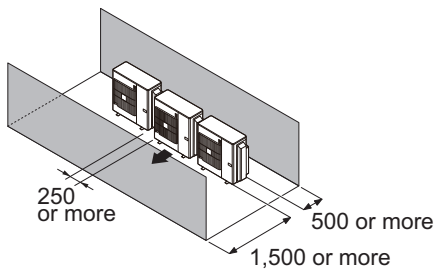

- When there is an obstruction in the upper space:

Unit: mm

When there are obstacles at the rear and above.

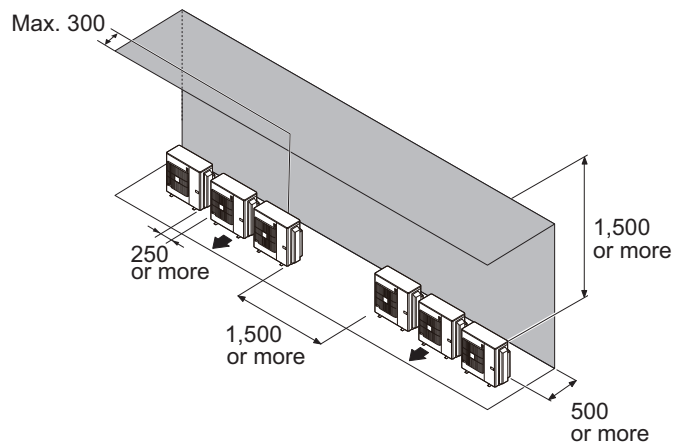

● Outdoor unit installation in multi-row

Unit: mm

Single parallel unit arrangement

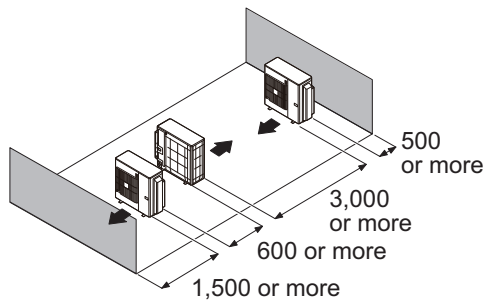

Multiple parallel unit arrangement

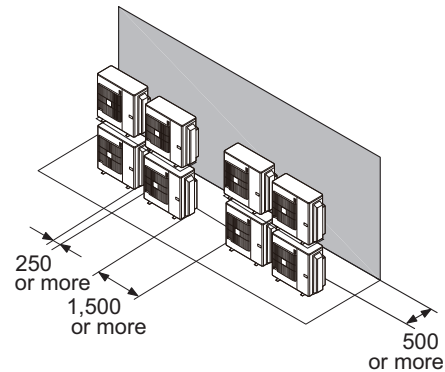
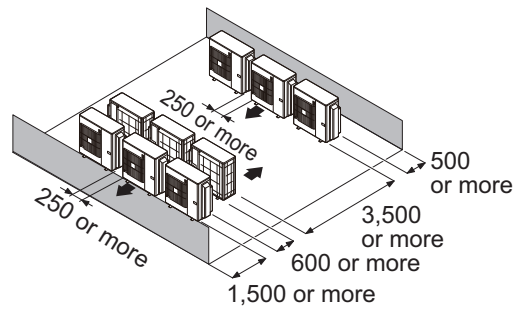

NOTES:

- If the space is larger than stated above, the condition will be the same as when there is no obstacle.
- Height above the floor level should be 50 mm or more.
- When installing the outdoor unit, be sure to open the front and left side to obtain better operation efficiency.

⚠ CAUTION

- Do not install the outdoor unit in two-stage where the drain water could freeze. Otherwise the drainage from the upper unit may form ice and cause a malfunction of the lower unit.
- When the outdoor temperature is 0 °C or less, do not use the accessory drain pipe and drain cap. If the drain pipe and drain cap are used, the drain water in the pipe may freeze in extremely cold climate. (For reverse cycle model only.)
- In area with heavy snowfall, if the inlet and outlet of the outdoor unit is blocked with snow, it might become difficult to get warm, and it is likely to cause product malfunction. Construct a canopy and a pedestal, or place the unit on a high stand that is locally installed.

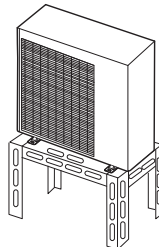

4. Refrigerant circuit

4-1. Model: AOYG45LBLA6

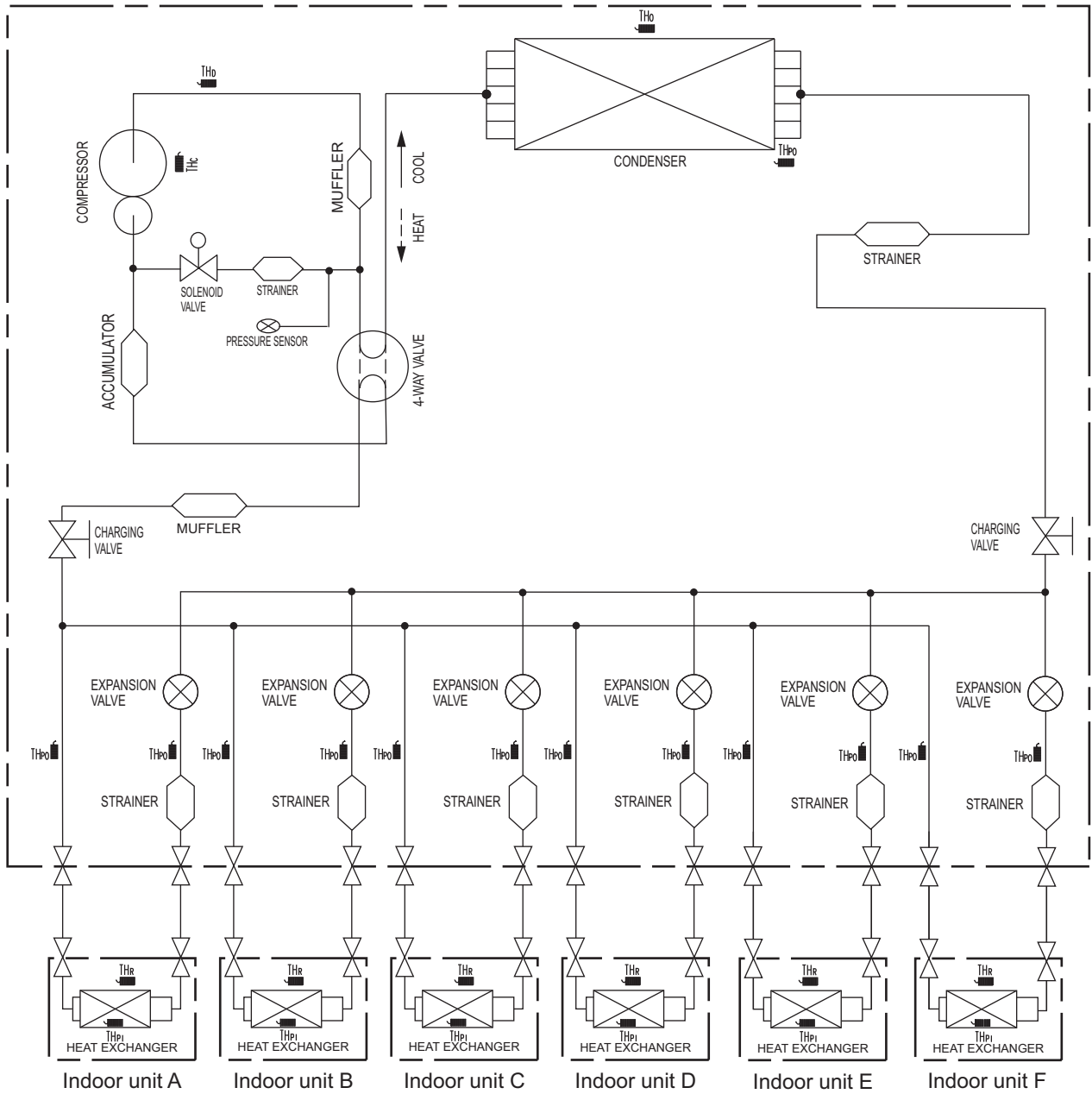

TH_c : THERMISTOR (COMPRESSOR TEMP.)
 TH_o : THERMISTOR (OUTDOOR TEMP.)
 TH_p : THERMISTOR (PIPE TEMP.)
 TH_r : THERMISTOR (ROOM TEMP.)

TH_r : THERMISTOR (ROOM TEMP.)
 TH_p : THERMISTOR (PIPE TEMP.)

OUTDOOR UNIT
AOYG45LBLA6

OUTDOOR UNIT
AOYG45LBLA6

5. Wiring diagram

5-1. Model: AOYG45LBLA6

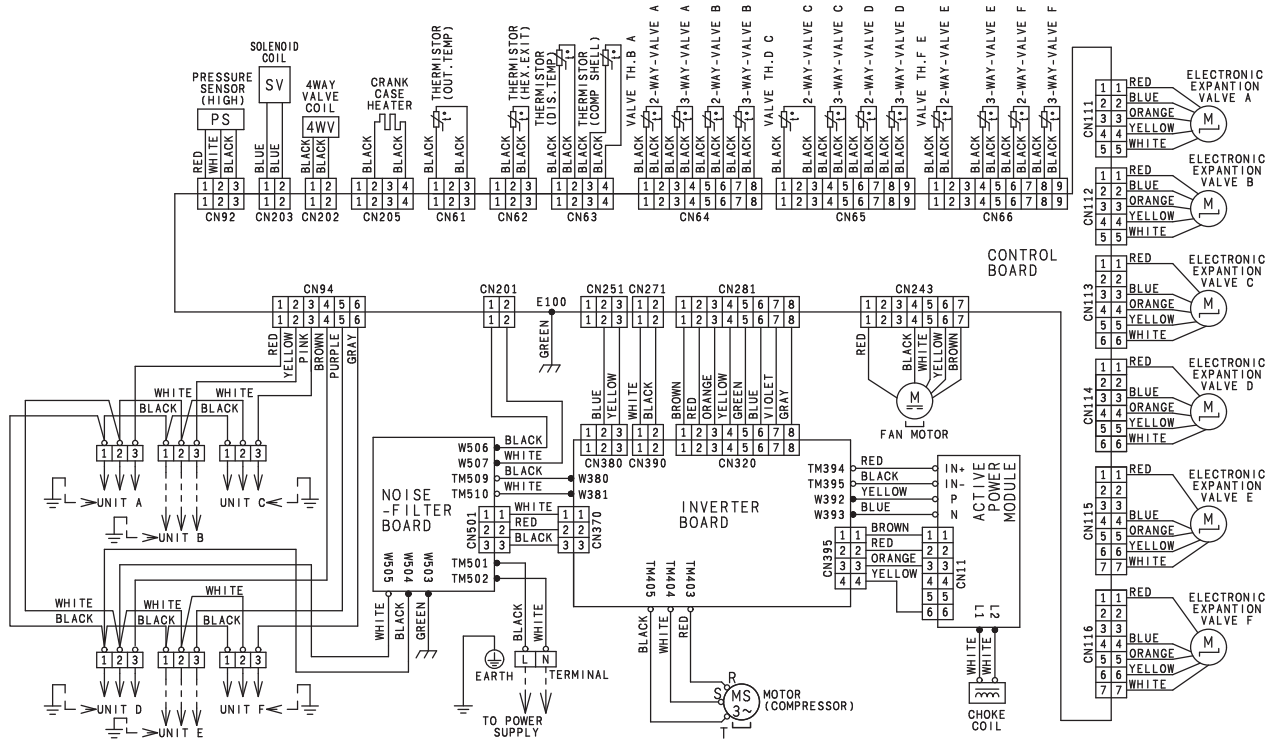

OUTDOOR UNIT
AOYG45LBLA6

OUTDOOR UNIT
AOYG45LBLA6

Combination of indoor unit							Rated capacity for each indoor unit (kW)						Total capacity (kW)			Input power (kW)			EER (W/W)
Room						Total	Room						Min.	Rated	Max.	Min.	Rated	Max.	
1	2	3	4	5	6		1	2	3	4	5	6							
7	9	9	9	9	9	52	1.70	2.16	2.16	2.16	2.16	2.16	3.5	12.5	14.0	0.80	3.52	4.84	3.55
7	9	9	9	9	12	55	1.59	2.05	2.05	2.05	2.05	2.71	3.5	12.5	14.0	0.80	3.50	4.84	3.57
7	9	9	9	9	14	57	1.54	1.97	1.97	1.97	1.97	3.08	3.5	12.5	14.0	0.80	3.49	4.84	3.58
7	9	9	9	12	12	58	1.50	1.94	1.94	1.94	2.59	2.59	3.5	12.5	14.0	0.80	3.48	4.84	3.59
7	9	9	9	12	14	60	1.46	1.88	1.88	1.88	2.50	2.90	3.5	12.5	14.0	0.80	3.47	4.84	3.60
7	9	9	12	12	12	61	1.44	1.84	1.84	2.46	2.46	2.46	3.5	12.5	14.0	0.80	3.47	4.84	3.60
9	9	9	9	9	9	54	2.08	2.08	2.08	2.08	2.08	2.08	3.5	12.5	14.0	0.80	3.51	4.84	3.56
9	9	9	9	9	12	57	1.97	1.97	1.97	1.97	1.97	2.65	3.5	12.5	14.0	0.80	3.49	4.84	3.58
9	9	9	9	12	12	60	1.88	1.88	1.88	1.88	2.49	2.49	3.5	12.5	14.0	0.80	3.47	4.84	3.60

NOTES:

- 7: 7,000 Btu/h, 9: 9,000 Btu/h, 12: 12,000 Btu/h, 14: 14,000 Btu/h, 18: 18,000 Btu/h, 24: 24,000 Btu/h
- Values mentioned in the table are based on the following conditions:
 - Power source of specifications: 230 V
 - Pipe length: 5 m, Height difference: 0 m [Outdoor unit—Indoor unit]
- 2 or more indoor units should be connected.
- The total ability of connected a indoor unit is from 34,000 Btu up to 62,000 Btu.

OUTDOOR UNIT
AOYG45LBLA6

OUTDOOR UNIT
AOYG45LBLA6

NOTES:

- 7: 7,000 Btu/h, 9: 9,000 Btu/h, 12: 12,000 Btu/h, 14: 14,000 Btu/h, 18: 18,000 Btu/h, 24: 24,000 Btu/h
- Values mentioned in the table are based on the following conditions:
 - Power source of specifications: 230 V
 - Pipe length: 5 m, Height difference: 0 m [Outdoor unit—Indoor unit]
- 2 or more indoor units should be connected.
- The total ability of connected a indoor unit is from 34,000 Btu up to 62,000 Btu.

6-2. Cooling capacity

Model: AOYG45LBLA6

NOTE: Values mentioned in the table are calculated based on the maximum capacity.

Indoor unit connect- ing capacity	Outdoor temperature	Indoor temperature											
		18.0 °CDB		21.0 °CDB		23.0 °CDB		27.0 °CDB		29.0 °CDB		32.0 °CDB	
		12.0 °CWB		15.0 °CWB		16.0 °CWB		19.0 °CWB		21.0 °CWB		23.0 °CWB	
kBtu/h	°CDB	TC	IP	TC	IP	TC	IP	TC	IP	TC	IP	TC	IP
62	-10.0	10.98	1.77	12.40	1.80	13.08	1.81	14.00	1.83	14.97	1.86	15.43	1.87
	-5.0	10.98	1.76	12.40	1.79	13.08	1.80	14.00	1.82	14.97	1.85	15.43	1.86
	0.0	10.98	1.75	12.40	1.78	13.08	1.79	14.00	1.81	14.97	1.84	15.43	1.85
	5.0	10.98	1.95	12.40	1.98	13.08	2.00	14.00	2.02	14.97	2.04	15.43	2.06
	10.0	10.98	2.15	12.40	2.19	13.08	2.20	14.00	2.23	14.97	2.25	15.43	2.27
	15.0	10.98	2.96	12.40	3.01	13.08	3.03	14.00	3.07	14.97	3.10	15.43	3.12
	20.0	10.98	3.77	12.40	3.83	13.08	3.86	14.00	3.91	14.97	3.95	15.43	3.97
	25.0	10.98	4.15	12.40	4.22	13.08	4.26	14.00	4.30	14.97	4.35	15.43	4.38
	30.0	10.98	4.53	12.40	4.61	13.08	4.65	14.00	4.70	14.97	4.76	15.43	4.78
	35.0	10.98	4.84	12.40	4.92	13.08	4.96	14.00	5.02	14.97	5.08	15.43	5.11
	40.0	9.55	4.49	10.79	4.57	11.37	4.61	12.18	4.66	13.02	4.71	13.42	4.74
46.0	8.12	4.15	9.18	4.22	9.67	4.25	10.36	4.30	11.07	4.35	11.41	4.37	
61	-10.0	10.98	1.77	12.40	1.80	13.08	1.81	14.00	1.83	14.97	1.86	15.43	1.87
	-5.0	10.98	1.76	12.40	1.79	13.08	1.80	14.00	1.82	14.97	1.85	15.43	1.86
	0.0	10.98	1.75	12.40	1.78	13.08	1.79	14.00	1.81	14.97	1.84	15.43	1.85
	5.0	10.98	1.95	12.40	1.98	13.08	2.00	14.00	2.02	14.97	2.04	15.43	2.06
	10.0	10.98	2.15	12.40	2.19	13.08	2.20	14.00	2.23	14.97	2.25	15.43	2.27
	15.0	10.98	2.96	12.40	3.01	13.08	3.03	14.00	3.07	14.97	3.10	15.43	3.12
	20.0	10.98	3.77	12.40	3.83	13.08	3.86	14.00	3.91	14.97	3.95	15.43	3.97
	25.0	10.98	4.15	12.40	4.22	13.08	4.26	14.00	4.30	14.97	4.35	15.43	4.38
	30.0	10.98	4.53	12.40	4.61	13.08	4.65	14.00	4.70	14.97	4.76	15.43	4.78
	35.0	10.98	4.84	12.40	4.92	13.08	4.96	14.00	5.02	14.97	5.08	15.43	5.11
	40.0	9.55	4.49	10.79	4.57	11.37	4.61	12.18	4.66	13.02	4.71	13.42	4.74
46.0	8.12	4.15	9.18	4.22	9.67	4.25	10.36	4.30	11.07	4.35	11.41	4.37	
60	-10.0	10.98	1.77	12.40	1.80	13.08	1.81	14.00	1.83	14.97	1.86	15.43	1.87
	-5.0	10.98	1.76	12.40	1.79	13.08	1.80	14.00	1.82	14.97	1.85	15.43	1.86
	0.0	10.98	1.75	12.40	1.78	13.08	1.79	14.00	1.81	14.97	1.84	15.43	1.85
	5.0	10.98	1.95	12.40	1.98	13.08	2.00	14.00	2.02	14.97	2.04	15.43	2.06
	10.0	10.98	2.15	12.40	2.19	13.08	2.20	14.00	2.23	14.97	2.25	15.43	2.27
	15.0	10.98	2.96	12.40	3.01	13.08	3.03	14.00	3.07	14.97	3.10	15.43	3.12
	20.0	10.98	3.77	12.40	3.83	13.08	3.86	14.00	3.91	14.97	3.95	15.43	3.97
	25.0	10.98	4.15	12.40	4.22	13.08	4.26	14.00	4.30	14.97	4.35	15.43	4.38
	30.0	10.98	4.53	12.40	4.61	13.08	4.65	14.00	4.70	14.97	4.76	15.43	4.78
	35.0	10.98	4.84	12.40	4.92	13.08	4.96	14.00	5.02	14.97	5.08	15.43	5.11
	40.0	9.55	4.49	10.79	4.57	11.37	4.61	12.18	4.66	13.02	4.71	13.42	4.74
46.0	8.12	4.15	9.18	4.22	9.67	4.25	10.36	4.30	11.07	4.35	11.41	4.37	
59	-10.0	10.98	1.77	12.40	1.80	13.08	1.81	14.00	1.83	14.97	1.86	15.43	1.87
	-5.0	10.98	1.76	12.40	1.79	13.08	1.80	14.00	1.82	14.97	1.85	15.43	1.86
	0.0	10.98	1.75	12.40	1.78	13.08	1.79	14.00	1.81	14.97	1.84	15.43	1.85
	5.0	10.98	1.95	12.40	1.98	13.08	2.00	14.00	2.02	14.97	2.04	15.43	2.06
	10.0	10.98	2.15	12.40	2.19	13.08	2.20	14.00	2.23	14.97	2.25	15.43	2.27
	15.0	10.98	2.96	12.40	3.01	13.08	3.03	14.00	3.07	14.97	3.10	15.43	3.12
	20.0	10.98	3.77	12.40	3.83	13.08	3.86	14.00	3.91	14.97	3.95	15.43	3.97
	25.0	10.98	4.15	12.40	4.22	13.08	4.26	14.00	4.30	14.97	4.35	15.43	4.38
	30.0	10.98	4.53	12.40	4.61	13.08	4.65	14.00	4.70	14.97	4.76	15.43	4.78
	35.0	10.98	4.84	12.40	4.92	13.08	4.96	14.00	5.02	14.97	5.08	15.43	5.11
	40.0	9.55	4.49	10.79	4.57	11.37	4.61	12.18	4.66	13.02	4.71	13.42	4.74
46.0	8.12	4.15	9.18	4.22	9.67	4.25	10.36	4.30	11.07	4.35	11.41	4.37	
58	-10.0	10.98	1.77	12.40	1.80	13.08	1.81	14.00	1.83	14.97	1.86	15.43	1.87
	-5.0	10.98	1.76	12.40	1.79	13.08	1.80	14.00	1.82	14.97	1.85	15.43	1.86
	0.0	10.98	1.75	12.40	1.78	13.08	1.79	14.00	1.81	14.97	1.84	15.43	1.85
	5.0	10.98	1.95	12.40	1.98	13.08	2.00	14.00	2.02	14.97	2.04	15.43	2.06
	10.0	10.98	2.15	12.40	2.19	13.08	2.20	14.00	2.23	14.97	2.25	15.43	2.27
	15.0	10.98	2.96	12.40	3.01	13.08	3.03	14.00	3.07	14.97	3.10	15.43	3.12
	20.0	10.98	3.77	12.40	3.83	13.08	3.86	14.00	3.91	14.97	3.95	15.43	3.97
	25.0	10.98	4.15	12.40	4.22	13.08	4.26	14.00	4.30	14.97	4.35	15.43	4.38
	30.0	10.98	4.53	12.40	4.61	13.08	4.65	14.00	4.70	14.97	4.76	15.43	4.78
	35.0	10.98	4.84	12.40	4.92	13.08	4.96	14.00	5.02	14.97	5.08	15.43	5.11
	40.0	9.55	4.49	10.79	4.57	11.37	4.61	12.18	4.66	13.02	4.71	13.42	4.74
46.0	8.12	4.15	9.18	4.22	9.67	4.25	10.36	4.30	11.07	4.35	11.41	4.37	
57	-10.0	10.98	1.77	12.40	1.80	13.08	1.81	14.00	1.83	14.97	1.86	15.43	1.87
	-5.0	10.98	1.76	12.40	1.79	13.08	1.80	14.00	1.82	14.97	1.85	15.43	1.86
	0.0	10.98	1.75	12.40	1.78	13.08	1.79	14.00	1.81	14.97	1.84	15.43	1.85
	5.0	10.98	1.95	12.40	1.98	13.08	2.00	14.00	2.02	14.97	2.04	15.43	2.06
	10.0	10.98	2.15	12.40	2.19	13.08	2.20	14.00	2.23	14.97	2.25	15.43	2.27
	15.0	10.98	2.96	12.40	3.01	13.08	3.03	14.00	3.07	14.97	3.10	15.43	3.12
	20.0	10.98	3.77	12.40	3.83	13.08	3.86	14.00	3.91	14.97	3.95	15.43	3.97
	25.0	10.98	4.15	12.40	4.22	13.08	4.26	14.00	4.30	14.97	4.35	15.43	4.38
	30.0	10.98	4.53	12.40	4.61	13.08	4.65	14.00	4.70	14.97	4.76	15.43	4.78
	35.0	10.98	4.84	12.40	4.92	13.08	4.96	14.00	5.02	14.97	5.08	15.43	5.11
	40.0	9.55	4.49	10.79	4.57	11.37	4.61	12.18	4.66	13.02	4.71	13.42	4.74
46.0	8.12	4.15	9.18	4.22	9.67	4.25	10.36	4.30	11.07	4.35	11.41	4.37	

OUTDOOR UNIT
AOYG45LBLA6

OUTDOOR UNIT
AOYG45LBLA6

Indoor unit connecting capacity	Outdoor temperature	Indoor temperature											
		18.0 °CDB		21.0 °CDB		23.0 °CDB		27.0 °CDB		29.0 °CDB		32.0 °CDB	
		12.0 °CWB		15.0 °CWB		16.0 °CWB		19.0 °CWB		21.0 °CWB		23.0 °CWB	
kBtu/h	°CDB	TC	IP	TC	IP	TC	IP	TC	IP	TC	IP	TC	IP
35	-10.0	9.80	1.42	11.08	1.45	11.68	1.46	12.50	1.48	13.36	1.49	13.78	1.50
	-5.0	9.80	1.42	11.08	1.44	11.68	1.45	12.50	1.47	13.36	1.48	13.78	1.49
	0.0	9.80	1.41	11.08	1.43	11.68	1.44	12.50	1.46	13.36	1.48	13.78	1.48
	5.0	9.80	1.57	11.08	1.60	11.68	1.61	12.50	1.63	13.36	1.65	13.78	1.65
	10.0	9.80	1.73	11.08	1.76	11.68	1.77	12.50	1.79	13.36	1.81	13.78	1.82
	15.0	9.80	2.38	11.08	2.42	11.68	2.44	12.50	2.47	13.36	2.50	13.78	2.51
	20.0	9.80	3.03	11.08	3.08	11.68	3.11	12.50	3.14	13.36	3.18	13.78	3.20
	25.0	9.80	3.34	11.08	3.40	11.68	3.43	12.50	3.46	13.36	3.50	13.78	3.52
	30.0	9.80	3.65	11.08	3.71	11.68	3.74	12.50	3.78	13.36	3.83	13.78	3.85
	35.0	9.80	3.89	11.08	3.96	11.68	4.00	12.50	4.04	13.36	4.09	13.78	4.11
34	40.0	8.52	3.62	9.63	3.68	10.16	3.71	10.87	3.75	11.62	3.79	11.98	3.81
	46.0	7.25	3.34	8.19	3.40	8.64	3.42	9.25	3.46	9.88	3.50	10.19	3.52
	-10.0	9.52	1.37	10.76	1.40	11.34	1.41	12.14	1.42	12.98	1.44	13.38	1.45
	-5.0	9.52	1.37	10.76	1.39	11.34	1.40	12.14	1.42	12.98	1.43	13.38	1.44
	0.0	9.52	1.36	10.76	1.38	11.34	1.39	12.14	1.41	12.98	1.43	13.38	1.43
	5.0	9.52	1.51	10.76	1.54	11.34	1.55	12.14	1.57	12.98	1.59	13.38	1.60
	10.0	9.52	1.67	10.76	1.70	11.34	1.71	12.14	1.73	12.98	1.75	13.38	1.76
	15.0	9.52	2.30	10.76	2.34	11.34	2.36	12.14	2.38	12.98	2.41	13.38	2.42
	20.0	9.52	2.93	10.76	2.98	11.34	3.00	12.14	3.03	12.98	3.07	13.38	3.09
	25.0	9.52	3.22	10.76	3.28	11.34	3.31	12.14	3.34	12.98	3.38	13.38	3.40
34	30.0	9.52	3.52	10.76	3.58	11.34	3.61	12.14	3.65	12.98	3.69	13.38	3.71
	35.0	9.52	3.76	10.76	3.83	11.34	3.86	12.14	3.90	12.98	3.94	13.38	3.97
	40.0	8.28	3.49	9.36	3.55	9.86	3.58	10.56	3.62	11.29	3.66	11.64	3.68
	46.0	7.04	3.22	7.96	3.28	8.39	3.30	8.98	3.34	9.60	3.38	9.90	3.40

NOTES:

- TC: Total Capacity (kW), IP: Input Power (kW)
- Values mentioned in the table are based on the following conditions:
 - Power source of specifications: 230 V
 - Pipe length: 5 m, Height difference: 0 m [Outdoor unit—Indoor unit]
- 2 or more indoor units should be connected.
- The total ability of connected a indoor unit is from 34,000 Btu up to 62,000 Btu.
- Input in the table are calculated based on the maximum indoor unit input combinations.

OUTDOOR UNIT
AOYG45LBLA6

OUTDOOR UNIT
AOYG45LBLA6

■ Compact cassette type

MODEL: AUYG07LVLA

Outdoor temperature	Indoor temperature (°CDB / °CWB)											
	18.0 / 12.0		21.0 / 15.0		23.0 / 16.0		27.0 / 19.0		29.0 / 21.0		32.0 / 23.0	
(°CDB)	TC	SHC	TC	SHC	TC	SHC	TC	SHC	TC	SHC	TC	SHC
-10.0	1.46	0.97	1.76	1.18	1.98	1.35	2.24	1.75	2.39	1.91	2.47	2.19
-5.0	1.46	0.97	1.76	1.18	1.98	1.35	2.24	1.75	2.39	1.91	2.47	2.19
0.0	1.46	0.97	1.76	1.18	1.98	1.35	2.24	1.75	2.39	1.91	2.47	2.19
5.0	1.46	0.97	1.76	1.18	1.98	1.35	2.24	1.75	2.39	1.91	2.47	2.19
10.0	1.46	0.97	1.76	1.18	1.98	1.35	2.24	1.75	2.39	1.91	2.47	2.19
15.0	1.46	0.97	1.76	1.18	1.98	1.35	2.24	1.75	2.39	1.91	2.47	2.19
20.0	1.46	0.97	1.76	1.18	1.98	1.35	2.24	1.75	2.39	1.91	2.47	2.19
25.0	1.46	0.97	1.76	1.18	1.98	1.35	2.24	1.75	2.39	1.91	2.47	2.19
30.0	1.46	0.97	1.76	1.18	1.98	1.35	2.24	1.75	2.39	1.91	2.47	2.19
35.0	1.46	0.97	1.76	1.18	1.98	1.35	2.24	1.75	2.39	1.91	2.47	2.19
40.0	1.27	0.74	1.53	0.90	1.73	1.02	1.95	1.32	2.08	1.45	2.15	1.66
46.0	1.08	0.53	1.30	0.65	1.47	0.74	1.66	0.96	1.77	1.05	1.83	1.20

MODEL: AUYG09LVLA

Outdoor temperature	Indoor temperature (°CDB / °CWB)											
	18.0 / 12.0		21.0 / 15.0		23.0 / 16.0		27.0 / 19.0		29.0 / 21.0		32.0 / 23.0	
(°CDB)	TC	SHC	TC	SHC	TC	SHC	TC	SHC	TC	SHC	TC	SHC
-10.0	1.88	1.23	2.26	1.50	2.55	1.71	2.88	2.22	3.08	2.43	3.17	2.78
-5.0	1.88	1.23	2.26	1.50	2.55	1.71	2.88	2.22	3.08	2.43	3.17	2.78
0.0	1.88	1.23	2.26	1.50	2.55	1.71	2.88	2.22	3.08	2.43	3.17	2.78
5.0	1.88	1.23	2.26	1.50	2.55	1.71	2.88	2.22	3.08	2.43	3.17	2.78
10.0	1.88	1.23	2.26	1.50	2.55	1.71	2.88	2.22	3.08	2.43	3.17	2.78
15.0	1.88	1.23	2.26	1.50	2.55	1.71	2.88	2.22	3.08	2.43	3.17	2.78
20.0	1.88	1.23	2.26	1.50	2.55	1.71	2.88	2.22	3.08	2.43	3.17	2.78
25.0	1.88	1.23	2.26	1.50	2.55	1.71	2.88	2.22	3.08	2.43	3.17	2.78
30.0	1.88	1.23	2.26	1.50	2.55	1.71	2.88	2.22	3.08	2.43	3.17	2.78
35.0	1.88	1.23	2.26	1.50	2.55	1.71	2.88	2.22	3.08	2.43	3.17	2.78
40.0	1.63	0.93	1.96	1.14	2.22	1.30	2.51	1.68	2.68	1.84	2.76	2.10
46.0	1.39	0.68	1.67	0.82	1.89	0.94	2.13	1.21	2.28	1.33	2.35	1.52

MODEL: AUYG12LVLB

Outdoor temperature	Indoor temperature (°CDB / °CWB)											
	18.0 / 12.0		21.0 / 15.0		23.0 / 16.0		27.0 / 19.0		29.0 / 21.0		32.0 / 23.0	
(°CDB)	TC	SHC	TC	SHC	TC	SHC	TC	SHC	TC	SHC	TC	SHC
-10.0	2.50	1.62	3.01	1.98	3.40	2.26	3.84	2.92	4.10	3.19	4.23	3.66
-5.0	2.50	1.62	3.01	1.98	3.40	2.26	3.84	2.92	4.10	3.19	4.23	3.66
0.0	2.50	1.62	3.01	1.98	3.40	2.26	3.84	2.92	4.10	3.19	4.23	3.66
5.0	2.50	1.62	3.01	1.98	3.40	2.26	3.84	2.92	4.10	3.19	4.23	3.66
10.0	2.50	1.62	3.01	1.98	3.40	2.26	3.84	2.92	4.10	3.19	4.23	3.66
15.0	2.50	1.62	3.01	1.98	3.40	2.26	3.84	2.92	4.10	3.19	4.23	3.66
20.0	2.50	1.62	3.01	1.98	3.40	2.26	3.84	2.92	4.10	3.19	4.23	3.66
25.0	2.50	1.62	3.01	1.98	3.40	2.26	3.84	2.92	4.10	3.19	4.23	3.66
30.0	2.50	1.62	3.01	1.98	3.40	2.26	3.84	2.92	4.10	3.19	4.23	3.66
35.0	2.50	1.62	3.01	1.98	3.40	2.26	3.84	2.92	4.10	3.19	4.23	3.66
40.0	2.18	1.23	2.62	1.50	2.96	1.71	3.34	2.21	3.57	2.42	3.68	2.77
46.0	1.85	0.89	2.23	1.08	2.52	1.23	2.84	1.60	3.04	1.75	3.13	2.00

MODEL: AUYG14LVLB

Outdoor temperature	Indoor temperature (°CDB / °CWB)											
	18.0 / 12.0		21.0 / 15.0		23.0 / 16.0		27.0 / 19.0		29.0 / 21.0		32.0 / 23.0	
(°CDB)	TC	SHC	TC	SHC	TC	SHC	TC	SHC	TC	SHC	TC	SHC
-10.0	2.92	1.79	3.51	2.19	3.97	2.49	4.48	3.23	4.79	3.53	4.94	4.04
-5.0	2.92	1.79	3.51	2.19	3.97	2.49	4.48	3.23	4.79	3.53	4.94	4.04
0.0	2.92	1.79	3.51	2.19	3.97	2.49	4.48	3.23	4.79	3.53	4.94	4.04
5.0	2.92	1.79	3.51	2.19	3.97	2.49	4.48	3.23	4.79	3.53	4.94	4.04
10.0	2.92	1.79	3.51	2.19	3.97	2.49	4.48	3.23	4.79	3.53	4.94	4.04
15.0	2.92	1.79	3.51	2.19	3.97	2.49	4.48	3.23	4.79	3.53	4.94	4.04
20.0	2.92	1.79	3.51	2.19	3.97	2.49	4.48	3.23	4.79	3.53	4.94	4.04
25.0	2.92	1.79	3.51	2.19	3.97	2.49	4.48	3.23	4.79	3.53	4.94	4.04
30.0	2.92	1.79	3.51	2.19	3.97	2.49	4.48	3.23	4.79	3.53	4.94	4.04
35.0	2.92	1.79	3.51	2.19	3.97	2.49	4.48	3.23	4.79	3.53	4.94	4.04
40.0	2.54	1.36	3.06	1.66	3.45	1.89	3.90	2.44	4.17	2.67	4.29	3.06
46.0	2.16	0.98	2.60	1.20	2.94	1.36	3.31	1.77	3.54	1.93	3.65	2.21

MODEL: AUYG18LVLB

Outdoor temperature (°CDB)	Indoor temperature (°CDB / °CWB)											
	18.0 / 12.0		21.0 / 15.0		23.0 / 16.0		27.0 / 19.0		29.0 / 21.0		32.0 / 23.0	
	TC	SHC	TC	SHC	TC	SHC	TC	SHC	TC	SHC	TC	SHC
-10.0	3.75	2.24	4.51	2.73	5.09	3.11	5.75	4.03	6.15	4.40	6.34	5.04
-5.0	3.75	2.24	4.51	2.73	5.09	3.11	5.75	4.03	6.15	4.40	6.34	5.04
0.0	3.75	2.24	4.51	2.73	5.09	3.11	5.75	4.03	6.15	4.40	6.34	5.04
5.0	3.75	2.24	4.51	2.73	5.09	3.11	5.75	4.03	6.15	4.40	6.34	5.04
10.0	3.75	2.24	4.51	2.73	5.09	3.11	5.75	4.03	6.15	4.40	6.34	5.04
15.0	3.75	2.24	4.51	2.73	5.09	3.11	5.75	4.03	6.15	4.40	6.34	5.04
20.0	3.75	2.24	4.51	2.73	5.09	3.11	5.75	4.03	6.15	4.40	6.34	5.04
25.0	3.75	2.24	4.51	2.73	5.09	3.11	5.75	4.03	6.15	4.40	6.34	5.04
30.0	3.75	2.24	4.51	2.73	5.09	3.11	5.75	4.03	6.15	4.40	6.34	5.04
35.0	3.75	2.24	4.51	2.73	5.09	3.11	5.75	4.03	6.15	4.40	6.34	5.04
40.0	3.26	1.69	3.92	2.07	4.43	2.35	5.00	3.05	5.35	3.33	5.51	3.82
46.0	2.77	1.23	3.33	1.49	3.77	1.70	4.25	2.20	4.55	2.41	4.69	2.76

NOTES:

- TC: Total Capacity (kW), SHC: Sensible Heat Capacity (kW)
- Values mentioned in the table are based on the following conditions:
 - Pipe length: 5 m, Height difference: 0 m [Outdoor unit—Indoor unit]

■ Mini duct type

MODEL: ARYG07LSLAP

Outdoor temperature	Indoor temperature (°CDB / °CWB)											
	18.0 / 12.0		21.0 / 15.0		23.0 / 16.0		27.0 / 19.0		29.0 / 21.0		32.0 / 23.0	
(°CDB)	TC	SHC	TC	SHC	TC	SHC	TC	SHC	TC	SHC	TC	SHC
-10.0	1.46	1.00	1.76	1.22	1.98	1.39	2.24	1.79	2.39	1.96	2.47	2.25
-5.0	1.46	1.00	1.76	1.22	1.98	1.39	2.24	1.79	2.39	1.96	2.47	2.25
0.0	1.46	1.00	1.76	1.22	1.98	1.39	2.24	1.79	2.39	1.96	2.47	2.25
5.0	1.46	1.00	1.76	1.22	1.98	1.39	2.24	1.79	2.39	1.96	2.47	2.25
10.0	1.46	1.00	1.76	1.22	1.98	1.39	2.24	1.79	2.39	1.96	2.47	2.25
15.0	1.46	1.00	1.76	1.22	1.98	1.39	2.24	1.79	2.39	1.96	2.47	2.25
20.0	1.46	1.00	1.76	1.22	1.98	1.39	2.24	1.79	2.39	1.96	2.47	2.25
25.0	1.46	1.00	1.76	1.22	1.98	1.39	2.24	1.79	2.39	1.96	2.47	2.25
30.0	1.46	1.00	1.76	1.22	1.98	1.39	2.24	1.79	2.39	1.96	2.47	2.25
35.0	1.46	1.00	1.76	1.22	1.98	1.39	2.24	1.79	2.39	1.96	2.47	2.25
40.0	1.27	0.75	1.53	0.92	1.73	1.05	1.95	1.36	2.08	1.48	2.15	1.70
46.0	1.08	0.55	1.30	0.66	1.47	0.76	1.66	0.98	1.77	1.07	1.83	1.23

MODEL: ARYG09LSLAP

Outdoor temperature	Indoor temperature (°CDB / °CWB)											
	18.0 / 12.0		21.0 / 15.0		23.0 / 16.0		27.0 / 19.0		29.0 / 21.0		32.0 / 23.0	
(°CDB)	TC	SHC	TC	SHC	TC	SHC	TC	SHC	TC	SHC	TC	SHC
-10.0	1.88	1.19	2.26	1.45	2.55	1.65	2.88	2.13	3.08	2.33	3.17	2.67
-5.0	1.88	1.19	2.26	1.45	2.55	1.65	2.88	2.13	3.08	2.33	3.17	2.67
0.0	1.88	1.19	2.26	1.45	2.55	1.65	2.88	2.13	3.08	2.33	3.17	2.67
5.0	1.88	1.19	2.26	1.45	2.55	1.65	2.88	2.13	3.08	2.33	3.17	2.67
10.0	1.88	1.19	2.26	1.45	2.55	1.65	2.88	2.13	3.08	2.33	3.17	2.67
15.0	1.88	1.19	2.26	1.45	2.55	1.65	2.88	2.13	3.08	2.33	3.17	2.67
20.0	1.88	1.19	2.26	1.45	2.55	1.65	2.88	2.13	3.08	2.33	3.17	2.67
25.0	1.88	1.19	2.26	1.45	2.55	1.65	2.88	2.13	3.08	2.33	3.17	2.67
30.0	1.88	1.19	2.26	1.45	2.55	1.65	2.88	2.13	3.08	2.33	3.17	2.67
35.0	1.88	1.19	2.26	1.45	2.55	1.65	2.88	2.13	3.08	2.33	3.17	2.67
40.0	1.63	0.90	1.96	1.09	2.22	1.25	2.51	1.61	2.68	1.76	2.76	2.02
46.0	1.39	0.65	1.67	0.79	1.89	0.90	2.13	1.17	2.28	1.28	2.35	1.46

MODEL: ARYG12LSLAP

Outdoor temperature	Indoor temperature (°CDB / °CWB)											
	18.0 / 12.0		21.0 / 15.0		23.0 / 16.0		27.0 / 19.0		29.0 / 21.0		32.0 / 23.0	
(°CDB)	TC	SHC	TC	SHC	TC	SHC	TC	SHC	TC	SHC	TC	SHC
-10.0	2.50	1.58	3.01	1.93	3.40	2.20	3.84	2.84	4.10	3.11	4.23	3.56
-5.0	2.50	1.58	3.01	1.93	3.40	2.20	3.84	2.84	4.10	3.11	4.23	3.56
0.0	2.50	1.58	3.01	1.93	3.40	2.20	3.84	2.84	4.10	3.11	4.23	3.56
5.0	2.50	1.58	3.01	1.93	3.40	2.20	3.84	2.84	4.10	3.11	4.23	3.56
10.0	2.50	1.58	3.01	1.93	3.40	2.20	3.84	2.84	4.10	3.11	4.23	3.56
15.0	2.50	1.58	3.01	1.93	3.40	2.20	3.84	2.84	4.10	3.11	4.23	3.56
20.0	2.50	1.58	3.01	1.93	3.40	2.20	3.84	2.84	4.10	3.11	4.23	3.56
25.0	2.50	1.58	3.01	1.93	3.40	2.20	3.84	2.84	4.10	3.11	4.23	3.56
30.0	2.50	1.58	3.01	1.93	3.40	2.20	3.84	2.84	4.10	3.11	4.23	3.56
35.0	2.50	1.58	3.01	1.93	3.40	2.20	3.84	2.84	4.10	3.11	4.23	3.56
40.0	2.18	1.20	2.62	1.46	2.96	1.66	3.34	2.15	3.57	2.35	3.68	2.69
46.0	1.85	0.86	2.23	1.05	2.52	1.20	2.84	1.55	3.04	1.70	3.13	1.95

MODEL: ARYG14LSLAP

Outdoor temperature	Indoor temperature (°CDB / °CWB)											
	18.0 / 12.0		21.0 / 15.0		23.0 / 16.0		27.0 / 19.0		29.0 / 21.0		32.0 / 23.0	
(°CDB)	TC	SHC	TC	SHC	TC	SHC	TC	SHC	TC	SHC	TC	SHC
-10.0	2.92	1.84	3.51	2.25	3.97	2.56	4.48	3.32	4.79	3.63	4.94	4.15
-5.0	2.92	1.84	3.51	2.25	3.97	2.56	4.48	3.32	4.79	3.63	4.94	4.15
0.0	2.92	1.84	3.51	2.25	3.97	2.56	4.48	3.32	4.79	3.63	4.94	4.15
5.0	2.92	1.84	3.51	2.25	3.97	2.56	4.48	3.32	4.79	3.63	4.94	4.15
10.0	2.92	1.84	3.51	2.25	3.97	2.56	4.48	3.32	4.79	3.63	4.94	4.15
15.0	2.92	1.84	3.51	2.25	3.97	2.56	4.48	3.32	4.79	3.63	4.94	4.15
20.0	2.92	1.84	3.51	2.25	3.97	2.56	4.48	3.32	4.79	3.63	4.94	4.15
25.0	2.92	1.84	3.51	2.25	3.97	2.56	4.48	3.32	4.79	3.63	4.94	4.15
30.0	2.92	1.84	3.51	2.25	3.97	2.56	4.48	3.32	4.79	3.63	4.94	4.15
35.0	2.92	1.84	3.51	2.25	3.97	2.56	4.48	3.32	4.79	3.63	4.94	4.15
40.0	2.54	1.40	3.06	1.70	3.45	1.94	3.90	2.51	4.17	2.74	4.29	3.14
46.0	2.16	1.01	2.60	1.23	2.94	1.40	3.31	1.81	3.54	1.98	3.65	2.27

MODEL: ARYG18LSLAP

Outdoor temperature	Indoor temperature (°CDB / °CWB)											
	18.0 / 12.0		21.0 / 15.0		23.0 / 16.0		27.0 / 19.0		29.0 / 21.0		32.0 / 23.0	
(°CDB)	TC	SHC	TC	SHC	TC	SHC	TC	SHC	TC	SHC	TC	SHC
-10.0	3.75	2.30	4.51	2.81	5.09	3.20	5.75	4.14	6.15	4.53	6.34	5.19
-5.0	3.75	2.30	4.51	2.81	5.09	3.20	5.75	4.14	6.15	4.53	6.34	5.19
0.0	3.75	2.30	4.51	2.81	5.09	3.20	5.75	4.14	6.15	4.53	6.34	5.19
5.0	3.75	2.30	4.51	2.81	5.09	3.20	5.75	4.14	6.15	4.53	6.34	5.19
10.0	3.75	2.30	4.51	2.81	5.09	3.20	5.75	4.14	6.15	4.53	6.34	5.19
15.0	3.75	2.30	4.51	2.81	5.09	3.20	5.75	4.14	6.15	4.53	6.34	5.19
20.0	3.75	2.30	4.51	2.81	5.09	3.20	5.75	4.14	6.15	4.53	6.34	5.19
25.0	3.75	2.30	4.51	2.81	5.09	3.20	5.75	4.14	6.15	4.53	6.34	5.19
30.0	3.75	2.30	4.51	2.81	5.09	3.20	5.75	4.14	6.15	4.53	6.34	5.19
35.0	3.75	2.30	4.51	2.81	5.09	3.20	5.75	4.14	6.15	4.53	6.34	5.19
40.0	3.26	1.74	3.92	2.12	4.43	2.42	5.00	3.13	5.35	3.43	5.51	3.93
46.0	2.77	1.26	3.33	1.54	3.77	1.75	4.25	2.27	4.55	2.48	4.69	2.84

NOTES:

- TC: Total Capacity (kW), SHC: Sensible Heat Capacity (kW)
- Values mentioned in the table are based on the following conditions:
 - Pipe length: 5 m, Height difference: 0 m [Outdoor unit—Indoor unit]

■ Slim duct type

MODEL: ARYG07LLTA

Outdoor temperature	Indoor temperature (°CDB / °CWB)											
	18.0 / 12.0		21.0 / 15.0		23.0 / 16.0		27.0 / 19.0		29.0 / 21.0		32.0 / 23.0	
(°CDB)	TC	SHC	TC	SHC	TC	SHC	TC	SHC	TC	SHC	TC	SHC
-10.0	1.46	1.00	1.76	1.22	1.98	1.39	2.24	1.79	2.39	1.96	2.47	2.25
-5.0	1.46	1.00	1.76	1.22	1.98	1.39	2.24	1.79	2.39	1.96	2.47	2.25
0.0	1.46	1.00	1.76	1.22	1.98	1.39	2.24	1.79	2.39	1.96	2.47	2.25
5.0	1.46	1.00	1.76	1.22	1.98	1.39	2.24	1.79	2.39	1.96	2.47	2.25
10.0	1.46	1.00	1.76	1.22	1.98	1.39	2.24	1.79	2.39	1.96	2.47	2.25
15.0	1.46	1.00	1.76	1.22	1.98	1.39	2.24	1.79	2.39	1.96	2.47	2.25
20.0	1.46	1.00	1.76	1.22	1.98	1.39	2.24	1.79	2.39	1.96	2.47	2.25
25.0	1.46	1.00	1.76	1.22	1.98	1.39	2.24	1.79	2.39	1.96	2.47	2.25
30.0	1.46	1.00	1.76	1.22	1.98	1.39	2.24	1.79	2.39	1.96	2.47	2.25
35.0	1.46	1.00	1.76	1.22	1.98	1.39	2.24	1.79	2.39	1.96	2.47	2.25
40.0	1.27	0.75	1.53	0.92	1.73	1.05	1.95	1.36	2.08	1.48	2.15	1.70
46.0	1.08	0.55	1.30	0.66	1.47	0.76	1.66	0.98	1.77	1.07	1.83	1.23

MODEL: ARYG09LLTA

Outdoor temperature	Indoor temperature (°CDB / °CWB)											
	18.0 / 12.0		21.0 / 15.0		23.0 / 16.0		27.0 / 19.0		29.0 / 21.0		32.0 / 23.0	
(°CDB)	TC	SHC	TC	SHC	TC	SHC	TC	SHC	TC	SHC	TC	SHC
-10.0	1.88	1.19	2.26	1.45	2.55	1.65	2.88	2.13	3.08	2.33	3.17	2.67
-5.0	1.88	1.19	2.26	1.45	2.55	1.65	2.88	2.13	3.08	2.33	3.17	2.67
0.0	1.88	1.19	2.26	1.45	2.55	1.65	2.88	2.13	3.08	2.33	3.17	2.67
5.0	1.88	1.19	2.26	1.45	2.55	1.65	2.88	2.13	3.08	2.33	3.17	2.67
10.0	1.88	1.19	2.26	1.45	2.55	1.65	2.88	2.13	3.08	2.33	3.17	2.67
15.0	1.88	1.19	2.26	1.45	2.55	1.65	2.88	2.13	3.08	2.33	3.17	2.67
20.0	1.88	1.19	2.26	1.45	2.55	1.65	2.88	2.13	3.08	2.33	3.17	2.67
25.0	1.88	1.19	2.26	1.45	2.55	1.65	2.88	2.13	3.08	2.33	3.17	2.67
30.0	1.88	1.19	2.26	1.45	2.55	1.65	2.88	2.13	3.08	2.33	3.17	2.67
35.0	1.88	1.19	2.26	1.45	2.55	1.65	2.88	2.13	3.08	2.33	3.17	2.67
40.0	1.63	0.90	1.96	1.09	2.22	1.25	2.51	1.61	2.68	1.76	2.76	2.02
46.0	1.39	0.65	1.67	0.79	1.89	0.90	2.13	1.17	2.28	1.28	2.35	1.46

MODEL: ARYG12LLTB

Outdoor temperature	Indoor temperature (°CDB / °CWB)											
	18.0 / 12.0		21.0 / 15.0		23.0 / 16.0		27.0 / 19.0		29.0 / 21.0		32.0 / 23.0	
(°CDB)	TC	SHC	TC	SHC	TC	SHC	TC	SHC	TC	SHC	TC	SHC
-10.0	2.50	1.58	3.01	1.93	3.40	2.20	3.84	2.84	4.10	3.11	4.23	3.56
-5.0	2.50	1.58	3.01	1.93	3.40	2.20	3.84	2.84	4.10	3.11	4.23	3.56
0.0	2.50	1.58	3.01	1.93	3.40	2.20	3.84	2.84	4.10	3.11	4.23	3.56
5.0	2.50	1.58	3.01	1.93	3.40	2.20	3.84	2.84	4.10	3.11	4.23	3.56
10.0	2.50	1.58	3.01	1.93	3.40	2.20	3.84	2.84	4.10	3.11	4.23	3.56
15.0	2.50	1.58	3.01	1.93	3.40	2.20	3.84	2.84	4.10	3.11	4.23	3.56
20.0	2.50	1.58	3.01	1.93	3.40	2.20	3.84	2.84	4.10	3.11	4.23	3.56
25.0	2.50	1.58	3.01	1.93	3.40	2.20	3.84	2.84	4.10	3.11	4.23	3.56
30.0	2.50	1.58	3.01	1.93	3.40	2.20	3.84	2.84	4.10	3.11	4.23	3.56
35.0	2.50	1.58	3.01	1.93	3.40	2.20	3.84	2.84	4.10	3.11	4.23	3.56
40.0	2.18	1.20	2.62	1.46	2.96	1.66	3.34	2.15	3.57	2.35	3.68	2.69
46.0	1.85	0.86	2.23	1.05	2.52	1.20	2.84	1.55	3.04	1.70	3.13	1.95

MODEL: ARYG14LLTB

Outdoor temperature	Indoor temperature (°CDB / °CWB)											
	18.0 / 12.0		21.0 / 15.0		23.0 / 16.0		27.0 / 19.0		29.0 / 21.0		32.0 / 23.0	
(°CDB)	TC	SHC	TC	SHC	TC	SHC	TC	SHC	TC	SHC	TC	SHC
-10.0	2.92	1.84	3.51	2.25	3.97	2.56	4.48	3.32	4.79	3.63	4.94	4.15
-5.0	2.92	1.84	3.51	2.25	3.97	2.56	4.48	3.32	4.79	3.63	4.94	4.15
0.0	2.92	1.84	3.51	2.25	3.97	2.56	4.48	3.32	4.79	3.63	4.94	4.15
5.0	2.92	1.84	3.51	2.25	3.97	2.56	4.48	3.32	4.79	3.63	4.94	4.15
10.0	2.92	1.84	3.51	2.25	3.97	2.56	4.48	3.32	4.79	3.63	4.94	4.15
15.0	2.92	1.84	3.51	2.25	3.97	2.56	4.48	3.32	4.79	3.63	4.94	4.15
20.0	2.92	1.84	3.51	2.25	3.97	2.56	4.48	3.32	4.79	3.63	4.94	4.15
25.0	2.92	1.84	3.51	2.25	3.97	2.56	4.48	3.32	4.79	3.63	4.94	4.15
30.0	2.92	1.84	3.51	2.25	3.97	2.56	4.48	3.32	4.79	3.63	4.94	4.15
35.0	2.92	1.84	3.51	2.25	3.97	2.56	4.48	3.32	4.79	3.63	4.94	4.15
40.0	2.54	1.40	3.06	1.70	3.45	1.94	3.90	2.51	4.17	2.74	4.29	3.14
46.0	2.16	1.01	2.60	1.23	2.94	1.40	3.31	1.81	3.54	1.98	3.65	2.27

MODEL: ARYG18LLTB

Outdoor temperature (°CDB)	Indoor temperature (°CDB / °CWB)											
	18.0 / 12.0		21.0 / 15.0		23.0 / 16.0		27.0 / 19.0		29.0 / 21.0		32.0 / 23.0	
	TC	SHC	TC	SHC	TC	SHC	TC	SHC	TC	SHC	TC	SHC
-10.0	3.75	2.30	4.51	2.81	5.09	3.20	5.75	4.14	6.15	4.53	6.34	5.19
-5.0	3.75	2.30	4.51	2.81	5.09	3.20	5.75	4.14	6.15	4.53	6.34	5.19
0.0	3.75	2.30	4.51	2.81	5.09	3.20	5.75	4.14	6.15	4.53	6.34	5.19
5.0	3.75	2.30	4.51	2.81	5.09	3.20	5.75	4.14	6.15	4.53	6.34	5.19
10.0	3.75	2.30	4.51	2.81	5.09	3.20	5.75	4.14	6.15	4.53	6.34	5.19
15.0	3.75	2.30	4.51	2.81	5.09	3.20	5.75	4.14	6.15	4.53	6.34	5.19
20.0	3.75	2.30	4.51	2.81	5.09	3.20	5.75	4.14	6.15	4.53	6.34	5.19
25.0	3.75	2.30	4.51	2.81	5.09	3.20	5.75	4.14	6.15	4.53	6.34	5.19
30.0	3.75	2.30	4.51	2.81	5.09	3.20	5.75	4.14	6.15	4.53	6.34	5.19
35.0	3.75	2.30	4.51	2.81	5.09	3.20	5.75	4.14	6.15	4.53	6.34	5.19
40.0	3.26	1.74	3.92	2.12	4.43	2.42	5.00	3.13	5.35	3.43	5.51	3.93
46.0	2.77	1.26	3.33	1.54	3.77	1.75	4.25	2.27	4.55	2.48	4.69	2.84

NOTES:

- TC: Total Capacity (kW), SHC: Sensible Heat Capacity (kW)
- Values mentioned in the table are based on the following conditions:
 - Pipe length: 5 m, Height difference: 0 m [Outdoor unit—Indoor unit]

■ Wall mounted type

MODELS: ASYG07LMCA, ASYG07LMCE, and ASYG07LUCA

Outdoor temperature	Indoor temperature (°CDB / °CWB)											
	18.0 / 12.0		21.0 / 15.0		23.0 / 16.0		27.0 / 19.0		29.0 / 21.0		32.0 / 23.0	
(°CDB)	TC	SHC	TC	SHC	TC	SHC	TC	SHC	TC	SHC	TC	SHC
-10.0	1.46	1.01	1.76	1.23	1.98	1.40	2.24	1.81	2.39	1.98	2.47	2.27
-5.0	1.46	1.01	1.76	1.23	1.98	1.40	2.24	1.81	2.39	1.98	2.47	2.27
0.0	1.46	1.01	1.76	1.23	1.98	1.40	2.24	1.81	2.39	1.98	2.47	2.27
5.0	1.46	1.01	1.76	1.23	1.98	1.40	2.24	1.81	2.39	1.98	2.47	2.27
10.0	1.46	1.01	1.76	1.23	1.98	1.40	2.24	1.81	2.39	1.98	2.47	2.27
15.0	1.46	1.01	1.76	1.23	1.98	1.40	2.24	1.81	2.39	1.98	2.47	2.27
20.0	1.46	1.01	1.76	1.23	1.98	1.40	2.24	1.81	2.39	1.98	2.47	2.27
25.0	1.46	1.01	1.76	1.23	1.98	1.40	2.24	1.81	2.39	1.98	2.47	2.27
30.0	1.46	1.01	1.76	1.23	1.98	1.40	2.24	1.81	2.39	1.98	2.47	2.27
35.0	1.46	1.01	1.76	1.23	1.98	1.40	2.24	1.81	2.39	1.98	2.47	2.27
40.0	1.27	0.76	1.53	0.93	1.73	1.06	1.95	1.37	2.08	1.50	2.15	1.72
46.0	1.08	0.55	1.30	0.67	1.47	0.77	1.66	0.99	1.77	1.09	1.83	1.24

MODELS: ASYG09LMCA, ASYG09LMCE, and ASYG09LUCA

Outdoor temperature	Indoor temperature (°CDB / °CWB)											
	18.0 / 12.0		21.0 / 15.0		23.0 / 16.0		27.0 / 19.0		29.0 / 21.0		32.0 / 23.0	
(°CDB)	TC	SHC	TC	SHC	TC	SHC	TC	SHC	TC	SHC	TC	SHC
-10.0	1.88	1.30	2.26	1.58	2.55	1.80	2.88	2.33	3.08	2.55	3.17	2.92
-5.0	1.88	1.30	2.26	1.58	2.55	1.80	2.88	2.33	3.08	2.55	3.17	2.92
0.0	1.88	1.30	2.26	1.58	2.55	1.80	2.88	2.33	3.08	2.55	3.17	2.92
5.0	1.88	1.30	2.26	1.58	2.55	1.80	2.88	2.33	3.08	2.55	3.17	2.92
10.0	1.88	1.30	2.26	1.58	2.55	1.80	2.88	2.33	3.08	2.55	3.17	2.92
15.0	1.88	1.30	2.26	1.58	2.55	1.80	2.88	2.33	3.08	2.55	3.17	2.92
20.0	1.88	1.30	2.26	1.58	2.55	1.80	2.88	2.33	3.08	2.55	3.17	2.92
25.0	1.88	1.30	2.26	1.58	2.55	1.80	2.88	2.33	3.08	2.55	3.17	2.92
30.0	1.88	1.30	2.26	1.58	2.55	1.80	2.88	2.33	3.08	2.55	3.17	2.92
35.0	1.88	1.30	2.26	1.58	2.55	1.80	2.88	2.33	3.08	2.55	3.17	2.92
40.0	1.63	0.98	1.96	1.20	2.22	1.36	2.51	1.77	2.68	1.93	2.76	2.21
46.0	1.39	0.71	1.67	0.87	1.89	0.99	2.13	1.28	2.28	1.40	2.35	1.60

MODELS: ASYG12LMCA, ASYG12LMCE, and ASYG12LUCA

Outdoor temperature	Indoor temperature (°CDB / °CWB)											
	18.0 / 12.0		21.0 / 15.0		23.0 / 16.0		27.0 / 19.0		29.0 / 21.0		32.0 / 23.0	
(°CDB)	TC	SHC	TC	SHC	TC	SHC	TC	SHC	TC	SHC	TC	SHC
-10.0	2.50	1.62	3.01	1.98	3.40	2.26	3.84	2.92	4.10	3.19	4.23	3.66
-5.0	2.50	1.62	3.01	1.98	3.40	2.26	3.84	2.92	4.10	3.19	4.23	3.66
0.0	2.50	1.62	3.01	1.98	3.40	2.26	3.84	2.92	4.10	3.19	4.23	3.66
5.0	2.50	1.62	3.01	1.98	3.40	2.26	3.84	2.92	4.10	3.19	4.23	3.66
10.0	2.50	1.62	3.01	1.98	3.40	2.26	3.84	2.92	4.10	3.19	4.23	3.66
15.0	2.50	1.62	3.01	1.98	3.40	2.26	3.84	2.92	4.10	3.19	4.23	3.66
20.0	2.50	1.62	3.01	1.98	3.40	2.26	3.84	2.92	4.10	3.19	4.23	3.66
25.0	2.50	1.62	3.01	1.98	3.40	2.26	3.84	2.92	4.10	3.19	4.23	3.66
30.0	2.50	1.62	3.01	1.98	3.40	2.26	3.84	2.92	4.10	3.19	4.23	3.66
35.0	2.50	1.62	3.01	1.98	3.40	2.26	3.84	2.92	4.10	3.19	4.23	3.66
40.0	2.18	1.23	2.62	1.50	2.96	1.71	3.34	2.21	3.57	2.42	3.68	2.77
46.0	1.85	0.89	2.23	1.08	2.52	1.23	2.84	1.60	3.04	1.75	3.13	2.00

MODELS: ASYG14LMCA, ASYG14LMCE, and ASYG14LUCA

Outdoor temperature	Indoor temperature (°CDB / °CWB)											
	18.0 / 12.0		21.0 / 15.0		23.0 / 16.0		27.0 / 19.0		29.0 / 21.0		32.0 / 23.0	
(°CDB)	TC	SHC	TC	SHC	TC	SHC	TC	SHC	TC	SHC	TC	SHC
-10.0	2.92	1.87	3.51	2.28	3.97	2.60	4.48	3.36	4.79	3.67	4.94	4.21
-5.0	2.92	1.87	3.51	2.28	3.97	2.60	4.48	3.36	4.79	3.67	4.94	4.21
0.0	2.92	1.87	3.51	2.28	3.97	2.60	4.48	3.36	4.79	3.67	4.94	4.21
5.0	2.92	1.87	3.51	2.28	3.97	2.60	4.48	3.36	4.79	3.67	4.94	4.21
10.0	2.92	1.87	3.51	2.28	3.97	2.60	4.48	3.36	4.79	3.67	4.94	4.21
15.0	2.92	1.87	3.51	2.28	3.97	2.60	4.48	3.36	4.79	3.67	4.94	4.21
20.0	2.92	1.87	3.51	2.28	3.97	2.60	4.48	3.36	4.79	3.67	4.94	4.21
25.0	2.92	1.87	3.51	2.28	3.97	2.60	4.48	3.36	4.79	3.67	4.94	4.21
30.0	2.92	1.87	3.51	2.28	3.97	2.60	4.48	3.36	4.79	3.67	4.94	4.21
35.0	2.92	1.87	3.51	2.28	3.97	2.60	4.48	3.36	4.79	3.67	4.94	4.21
40.0	2.54	1.41	3.06	1.72	3.45	1.97	3.90	2.54	4.17	2.78	4.29	3.19
46.0	2.16	1.02	2.60	1.25	2.94	1.42	3.31	1.84	3.54	2.01	3.65	2.30

MODEL: ASYG18LFCA

Outdoor temperature	Indoor temperature (°CDB / °CWB)											
	18.0 / 12.0		21.0 / 15.0		23.0 / 16.0		27.0 / 19.0		29.0 / 21.0		32.0 / 23.0	
(°CDB)	TC	SHC	TC	SHC	TC	SHC	TC	SHC	TC	SHC	TC	SHC
-10.0	3.75	2.46	4.51	3.00	5.09	3.42	5.75	4.43	6.15	4.84	6.34	5.55
-5.0	3.75	2.46	4.51	3.00	5.09	3.42	5.75	4.43	6.15	4.84	6.34	5.55
0.0	3.75	2.46	4.51	3.00	5.09	3.42	5.75	4.43	6.15	4.84	6.34	5.55
5.0	3.75	2.46	4.51	3.00	5.09	3.42	5.75	4.43	6.15	4.84	6.34	5.55
10.0	3.75	2.46	4.51	3.00	5.09	3.42	5.75	4.43	6.15	4.84	6.34	5.55
15.0	3.75	2.46	4.51	3.00	5.09	3.42	5.75	4.43	6.15	4.84	6.34	5.55
20.0	3.75	2.46	4.51	3.00	5.09	3.42	5.75	4.43	6.15	4.84	6.34	5.55
25.0	3.75	2.46	4.51	3.00	5.09	3.42	5.75	4.43	6.15	4.84	6.34	5.55
30.0	3.75	2.46	4.51	3.00	5.09	3.42	5.75	4.43	6.15	4.84	6.34	5.55
35.0	3.75	2.46	4.51	3.00	5.09	3.42	5.75	4.43	6.15	4.84	6.34	5.55
40.0	3.26	1.86	3.92	2.27	4.43	2.59	5.00	3.35	5.35	3.66	5.51	4.20
46.0	2.77	1.35	3.33	1.64	3.77	1.87	4.25	2.42	4.55	2.65	4.69	3.04

MODELS: ASYG24LFCA and ASYG24LFCC

Outdoor temperature	Indoor temperature (°CDB / °CWB)											
	18.0 / 12.0		21.0 / 15.0		23.0 / 16.0		27.0 / 19.0		29.0 / 21.0		32.0 / 23.0	
(°CDB)	TC	SHC	TC	SHC	TC	SHC	TC	SHC	TC	SHC	TC	SHC
-10.0	5.00	2.99	6.01	3.64	6.80	4.15	7.67	5.37	8.20	5.87	8.45	6.73
-5.0	5.00	2.99	6.01	3.64	6.80	4.15	7.67	5.37	8.20	5.87	8.45	6.73
0.0	5.00	2.99	6.01	3.64	6.80	4.15	7.67	5.37	8.20	5.87	8.45	6.73
5.0	5.00	2.99	6.01	3.64	6.80	4.15	7.67	5.37	8.20	5.87	8.45	6.73
10.0	5.00	2.99	6.01	3.64	6.80	4.15	7.67	5.37	8.20	5.87	8.45	6.73
15.0	5.00	2.99	6.01	3.64	6.80	4.15	7.67	5.37	8.20	5.87	8.45	6.73
20.0	5.00	2.99	6.01	3.64	6.80	4.15	7.67	5.37	8.20	5.87	8.45	6.73
25.0	5.00	2.99	6.01	3.64	6.80	4.15	7.67	5.37	8.20	5.87	8.45	6.73
30.0	5.00	2.99	6.01	3.64	6.80	4.15	7.67	5.37	8.20	5.87	8.45	6.73
35.0	5.00	2.99	6.01	3.64	6.80	4.15	7.67	5.37	8.20	5.87	8.45	6.73
40.0	4.35	2.26	5.23	2.76	5.91	3.14	6.67	4.06	7.13	4.44	7.35	5.09
46.0	3.70	1.63	4.45	1.99	5.03	2.27	5.67	2.94	6.07	3.21	6.25	3.68

NOTES:

- TC: Total Capacity (kW), SHC: Sensible Heat Capacity (kW)
- Values mentioned in the table are based on the following conditions:
 - Pipe length: 5 m, Height difference: 0 m [Outdoor unit—Indoor unit]

■ Floor/Ceiling type

MODEL: ABYG14LVTA

Outdoor temperature	Indoor temperature (°CDB / °CWB)											
	18.0 / 12.0		21.0 / 15.0		23.0 / 16.0		27.0 / 19.0		29.0 / 21.0		32.0 / 23.0	
(°CDB)	TC	SHC	TC	SHC	TC	SHC	TC	SHC	TC	SHC	TC	SHC
-10.0	2.92	1.79	3.51	2.19	3.97	2.49	4.48	3.23	4.79	3.53	4.94	4.04
-5.0	2.92	1.79	3.51	2.19	3.97	2.49	4.48	3.23	4.79	3.53	4.94	4.04
0.0	2.92	1.79	3.51	2.19	3.97	2.49	4.48	3.23	4.79	3.53	4.94	4.04
5.0	2.92	1.79	3.51	2.19	3.97	2.49	4.48	3.23	4.79	3.53	4.94	4.04
10.0	2.92	1.79	3.51	2.19	3.97	2.49	4.48	3.23	4.79	3.53	4.94	4.04
15.0	2.92	1.79	3.51	2.19	3.97	2.49	4.48	3.23	4.79	3.53	4.94	4.04
20.0	2.92	1.79	3.51	2.19	3.97	2.49	4.48	3.23	4.79	3.53	4.94	4.04
25.0	2.92	1.79	3.51	2.19	3.97	2.49	4.48	3.23	4.79	3.53	4.94	4.04
30.0	2.92	1.79	3.51	2.19	3.97	2.49	4.48	3.23	4.79	3.53	4.94	4.04
35.0	2.92	1.79	3.51	2.19	3.97	2.49	4.48	3.23	4.79	3.53	4.94	4.04
40.0	2.54	1.36	3.06	1.66	3.45	1.89	3.90	2.44	4.17	2.67	4.29	3.06
46.0	2.16	0.98	2.60	1.20	2.94	1.36	3.31	1.77	3.54	1.93	3.65	2.21

MODEL: ABYG18LVTB

Outdoor temperature	Indoor temperature (°CDB / °CWB)											
	18.0 / 12.0		21.0 / 15.0		23.0 / 16.0		27.0 / 19.0		29.0 / 21.0		32.0 / 23.0	
(°CDB)	TC	SHC	TC	SHC	TC	SHC	TC	SHC	TC	SHC	TC	SHC
-10.0	3.75	2.24	4.51	2.73	5.09	3.11	5.75	4.03	6.15	4.12	6.34	5.04
-5.0	3.75	2.24	4.51	2.73	5.09	3.11	5.75	4.03	6.15	4.40	6.34	5.04
0.0	3.75	2.24	4.51	2.73	5.09	3.11	5.75	4.03	6.15	4.40	6.34	5.04
5.0	3.75	2.24	4.51	2.73	5.09	3.11	5.75	4.03	6.15	4.40	6.34	5.04
10.0	3.75	2.24	4.51	2.73	5.09	3.11	5.75	4.03	6.15	4.40	6.34	5.04
15.0	3.75	2.24	4.51	2.73	5.09	3.11	5.75	4.03	6.15	4.40	6.34	5.04
20.0	3.75	2.24	4.51	2.73	5.09	3.11	5.75	4.03	6.15	4.40	6.34	5.04
25.0	3.75	2.24	4.51	2.73	5.09	3.11	5.75	4.03	6.15	4.40	6.34	5.04
30.0	3.75	2.24	4.51	2.73	5.09	3.11	5.75	4.03	6.15	4.40	6.34	5.04
35.0	3.75	2.24	4.51	2.73	5.09	3.11	5.75	4.03	6.15	4.40	6.34	5.04
40.0	3.26	1.69	3.92	2.07	4.43	2.35	5.00	3.05	5.35	3.33	5.51	3.82
46.0	2.77	1.23	3.33	1.49	3.77	1.70	4.25	2.20	4.55	2.41	4.69	2.76

NOTES:

- TC: Total Capacity (kW), SHC: Sensible Heat Capacity (kW)
- Values mentioned in the table are based on the following conditions:
 - Pipe length: 5 m, Height difference: 0 m [Outdoor unit—Indoor unit]

■ Floor type

MODEL: AGYG09LVCA

Outdoor temperature	Indoor temperature (°CDB / °CWB)											
	18.0 / 12.0		21.0 / 15.0		23.0 / 16.0		27.0 / 19.0		29.0 / 21.0		32.0 / 23.0	
(°CDB)	TC	SHC	TC	SHC	TC	SHC	TC	SHC	TC	SHC	TC	SHC
-10.0	1.88	1.27	2.26	1.54	2.55	1.76	2.88	2.28	3.08	2.49	3.17	2.85
-5.0	1.88	1.27	2.26	1.54	2.55	1.76	2.88	2.28	3.08	2.49	3.17	2.85
0.0	1.88	1.27	2.26	1.54	2.55	1.76	2.88	2.28	3.08	2.49	3.17	2.85
5.0	1.88	1.27	2.26	1.54	2.55	1.76	2.88	2.28	3.08	2.49	3.17	2.85
10.0	1.88	1.27	2.26	1.54	2.55	1.76	2.88	2.28	3.08	2.49	3.17	2.85
15.0	1.88	1.27	2.26	1.54	2.55	1.76	2.88	2.28	3.08	2.49	3.17	2.85
20.0	1.88	1.27	2.26	1.54	2.55	1.76	2.88	2.28	3.08	2.49	3.17	2.85
25.0	1.88	1.27	2.26	1.54	2.55	1.76	2.88	2.28	3.08	2.49	3.17	2.85
30.0	1.88	1.27	2.26	1.54	2.55	1.76	2.88	2.28	3.08	2.49	3.17	2.85
35.0	1.88	1.27	2.26	1.54	2.55	1.76	2.88	2.28	3.08	2.49	3.17	2.85
40.0	1.63	0.96	1.96	1.17	2.22	1.33	2.51	1.72	2.68	1.88	2.76	2.16
46.0	1.39	0.69	1.67	0.84	1.89	0.96	2.13	1.25	2.28	1.36	2.35	1.56

MODEL: AGYG12LVCA

Outdoor temperature	Indoor temperature (°CDB / °CWB)											
	18.0 / 12.0		21.0 / 15.0		23.0 / 16.0		27.0 / 19.0		29.0 / 21.0		32.0 / 23.0	
(°CDB)	TC	SHC	TC	SHC	TC	SHC	TC	SHC	TC	SHC	TC	SHC
-10.0	2.50	1.58	3.01	1.93	3.40	2.20	3.84	2.84	4.10	3.11	4.23	3.56
-5.0	2.50	1.58	3.01	1.93	3.40	2.20	3.84	2.84	4.10	3.11	4.23	3.56
0.0	2.50	1.58	3.01	1.93	3.40	2.20	3.84	2.84	4.10	3.11	4.23	3.56
5.0	2.50	1.58	3.01	1.93	3.40	2.20	3.84	2.84	4.10	3.11	4.23	3.56
10.0	2.50	1.58	3.01	1.93	3.40	2.20	3.84	2.84	4.10	3.11	4.23	3.56
15.0	2.50	1.58	3.01	1.93	3.40	2.20	3.84	2.84	4.10	3.11	4.23	3.56
20.0	2.50	1.58	3.01	1.93	3.40	2.20	3.84	2.84	4.10	3.11	4.23	3.56
25.0	2.50	1.58	3.01	1.93	3.40	2.20	3.84	2.84	4.10	3.11	4.23	3.56
30.0	2.50	1.58	3.01	1.93	3.40	2.20	3.84	2.84	4.10	3.11	4.23	3.56
35.0	2.50	1.58	3.01	1.93	3.40	2.20	3.84	2.84	4.10	3.11	4.23	3.56
40.0	2.18	1.20	2.62	1.46	2.96	1.66	3.34	2.15	3.57	2.35	3.68	2.69
46.0	1.85	0.86	2.23	1.05	2.52	1.20	2.84	1.55	3.04	1.70	3.13	1.95

MODEL: AGYG14LVCA

Outdoor temperature	Indoor temperature (°CDB / °CWB)											
	18.0 / 12.0		21.0 / 15.0		23.0 / 16.0		27.0 / 19.0		29.0 / 21.0		32.0 / 23.0	
(°CDB)	TC	SHC	TC	SHC	TC	SHC	TC	SHC	TC	SHC	TC	SHC
-10.0	2.92	1.79	3.51	2.19	3.97	2.49	4.48	3.23	4.79	3.53	4.94	4.04
-5.0	2.92	1.79	3.51	2.19	3.97	2.49	4.48	3.23	4.79	3.53	4.94	4.04
0.0	2.92	1.79	3.51	2.19	3.97	2.49	4.48	3.23	4.79	3.53	4.94	4.04
5.0	2.92	1.79	3.51	2.19	3.97	2.49	4.48	3.23	4.79	3.53	4.94	4.04
10.0	2.92	1.79	3.51	2.19	3.97	2.49	4.48	3.23	4.79	3.53	4.94	4.04
15.0	2.92	1.79	3.51	2.19	3.97	2.49	4.48	3.23	4.79	3.53	4.94	4.04
20.0	2.92	1.79	3.51	2.19	3.97	2.49	4.48	3.23	4.79	3.53	4.94	4.04
25.0	2.92	1.79	3.51	2.19	3.97	2.49	4.48	3.23	4.79	3.53	4.94	4.04
30.0	2.92	1.79	3.51	2.19	3.97	2.49	4.48	3.23	4.79	3.53	4.94	4.04
35.0	2.92	1.79	3.51	2.19	3.97	2.49	4.48	3.23	4.79	3.53	4.94	4.04
40.0	2.54	1.36	3.06	1.66	3.45	1.89	3.90	2.44	4.17	2.67	4.29	3.06
46.0	2.16	0.98	2.60	1.20	2.94	1.36	3.31	1.77	3.54	1.93	3.65	2.21

NOTES:

- TC: Total Capacity (kW), SHC: Sensible Heat Capacity (kW)
- Values mentioned in the table are based on the following conditions:
 - Pipe length: 5 m, Height difference: 0 m [Outdoor unit—Indoor unit]

6-3. Heating capacity

■ Model: AOYG45LBLA6

NOTE: Values mentioned in the table are calculated based on the maximum capacity.

Indoor unit connecting capacity	Outdoor temperature		Indoor temperature									
			16.0 °CDB		18.0 °CDB		20.0 °CDB		22.0 °CDB		24.0 °CDB	
kBtu/h	°CDB	°CWB	TC	IP	TC	IP	TC	IP	TC	IP	TC	IP
62	-15.0	-16.0	10.83	5.10	10.31	5.10	9.90	5.10	9.69	5.09	9.49	5.08
	-10.0	-11.0	12.04	5.10	11.48	5.10	11.10	5.10	10.86	5.09	10.63	5.08
	-5.0	-7.0	13.43	5.10	12.87	5.10	12.40	5.10	12.21	5.09	12.03	5.07
	0.0	-2.0	15.48	5.10	14.89	5.10	14.30	5.10	13.95	5.07	13.61	5.05
	5.0	3.0	17.68	5.10	16.85	5.10	15.60	5.10	15.08	4.95	14.56	4.80
	7.0	6.0	18.50	4.77	17.40	4.68	16.00	4.59	15.25	4.36	14.50	4.12
	10.0	8.0	18.37	4.77	17.28	4.68	16.00	4.59	15.26	4.46	14.52	4.33
	15.0	10.0	18.34	4.49	17.17	4.40	16.00	4.28	15.32	4.15	14.63	4.02
61	20.0	15.0	17.37	3.89	16.28	3.81	15.27	3.70	14.68	3.58	14.08	3.47
	24.0	18.0	16.35	3.55	15.41	3.48	14.55	3.38	14.30	3.35	14.04	3.31
	-15.0	-16.0	10.83	5.10	10.31	5.10	9.90	5.10	9.69	5.09	9.49	5.08
	-10.0	-11.0	12.04	5.10	11.48	5.10	11.10	5.10	10.86	5.09	10.63	5.08
	-5.0	-7.0	13.43	5.10	12.87	5.10	12.40	5.10	12.21	5.09	12.03	5.07
	0.0	-2.0	15.48	5.10	14.89	5.10	14.30	5.10	13.95	5.07	13.61	5.05
	5.0	3.0	17.68	5.10	16.85	5.10	15.60	5.10	15.08	4.95	14.56	4.80
	7.0	6.0	18.50	4.77	17.40	4.68	16.00	4.59	15.25	4.36	14.50	4.12
60	10.0	8.0	18.37	4.77	17.28	4.68	16.00	4.59	15.26	4.46	14.52	4.33
	15.0	10.0	18.34	4.49	17.17	4.40	16.00	4.28	15.32	4.15	14.63	4.02
	20.0	15.0	17.37	3.89	16.28	3.81	15.27	3.70	14.68	3.58	14.08	3.47
	24.0	18.0	16.35	3.55	15.41	3.48	14.55	3.38	14.30	3.35	14.04	3.31
	-15.0	-16.0	10.83	5.10	10.31	5.10	9.90	5.10	9.69	5.09	9.49	5.08
	-10.0	-11.0	12.04	5.10	11.48	5.10	11.10	5.10	10.86	5.09	10.63	5.08
	-5.0	-7.0	13.43	5.10	12.87	5.10	12.40	5.10	12.21	5.09	12.03	5.07
	0.0	-2.0	15.48	5.10	14.89	5.10	14.30	5.10	13.95	5.07	13.61	5.05
59	5.0	3.0	17.68	5.10	16.85	5.10	15.60	5.10	15.08	4.95	14.56	4.80
	7.0	6.0	18.50	4.77	17.40	4.68	16.00	4.59	15.25	4.36	14.50	4.12
	10.0	8.0	18.37	4.77	17.28	4.68	16.00	4.59	15.26	4.46	14.52	4.33
	15.0	10.0	18.34	4.49	17.17	4.40	16.00	4.28	15.32	4.15	14.63	4.02
	20.0	15.0	17.37	3.89	16.28	3.81	15.27	3.70	14.68	3.58	14.08	3.47
	24.0	18.0	16.35	3.55	15.41	3.48	14.55	3.38	14.30	3.35	14.04	3.31
	-15.0	-16.0	10.83	5.10	10.31	5.10	9.90	5.10	9.69	5.09	9.49	5.08
	-10.0	-11.0	12.04	5.10	11.48	5.10	11.10	5.10	10.86	5.09	10.63	5.08
58	-5.0	-7.0	13.43	5.10	12.87	5.10	12.40	5.10	12.21	5.09	12.03	5.07
	0.0	-2.0	15.48	5.10	14.89	5.10	14.30	5.10	13.95	5.07	13.61	5.05
	5.0	3.0	17.68	5.10	16.85	5.10	15.60	5.10	15.08	4.95	14.56	4.80
	7.0	6.0	18.50	4.77	17.40	4.68	16.00	4.59	15.25	4.36	14.50	4.12
	10.0	8.0	18.37	4.77	17.28	4.68	16.00	4.59	15.26	4.46	14.52	4.33
	15.0	10.0	18.34	4.49	17.17	4.40	16.00	4.28	15.32	4.15	14.63	4.02
	20.0	15.0	17.37	3.89	16.28	3.81	15.27	3.70	14.68	3.58	14.08	3.47
	24.0	18.0	16.35	3.55	15.41	3.48	14.55	3.38	14.30	3.35	14.04	3.31
57	-15.0	-16.0	10.83	5.10	10.31	5.10	9.90	5.10	9.69	5.09	9.49	5.08
	-10.0	-11.0	12.04	5.10	11.48	5.10	11.10	5.10	10.86	5.09	10.63	5.08
	-5.0	-7.0	13.43	5.10	12.87	5.10	12.40	5.10	12.21	5.09	12.03	5.07
	0.0	-2.0	15.48	5.10	14.89	5.10	14.30	5.10	13.95	5.07	13.61	5.05
	5.0	3.0	17.68	5.10	16.85	5.10	15.60	5.10	15.08	4.95	14.56	4.80
	7.0	6.0	18.50	4.77	17.40	4.68	16.00	4.59	15.25	4.36	14.50	4.12
	10.0	8.0	18.37	4.77	17.28	4.68	16.00	4.59	15.26	4.46	14.52	4.33
	15.0	10.0	18.34	4.49	17.17	4.40	16.00	4.28	15.32	4.15	14.63	4.02
56	20.0	15.0	17.37	3.89	16.28	3.81	15.27	3.70	14.68	3.58	14.08	3.47
	24.0	18.0	16.35	3.55	15.41	3.48	14.55	3.38	14.30	3.35	14.04	3.31
	-15.0	-16.0	10.83	5.10	10.31	5.10	9.90	5.10	9.69	5.09	9.49	5.08
	-10.0	-11.0	12.04	5.10	11.48	5.10	11.10	5.10	10.86	5.09	10.63	5.08
	-5.0	-7.0	13.43	5.10	12.87	5.10	12.40	5.10	12.21	5.09	12.03	5.07
	0.0	-2.0	15.48	5.10	14.89	5.10	14.30	5.10	13.95	5.07	13.61	5.05
	5.0	3.0	17.68	5.10	16.85	5.10	15.60	5.10	15.08	4.95	14.56	4.80
	7.0	6.0	18.50	4.77	17.40	4.68	16.00	4.59	15.25	4.36	14.50	4.12
55	10.0	8.0	18.37	4.77	17.28	4.68	16.00	4.59	15.26	4.46	14.52	4.33
	15.0	10.0	18.34	4.49	17.17	4.40	16.00	4.28	15.32	4.15	14.63	4.02
	20.0	15.0	17.37	3.89	16.28	3.81	15.27	3.70	14.68	3.58	14.08	3.47
	24.0	18.0	16.35	3.55	15.41	3.48	14.55	3.38	14.30	3.35	14.04	3.31

OUTDOOR UNIT
AOYG45LBLA6

OUTDOOR UNIT
AOYG45LBLA6

Indoor unit connecting capacity	Outdoor temperature		Indoor temperature									
			16.0 °CDB		18.0 °CDB		20.0 °CDB		22.0 °CDB		24.0 °CDB	
	kBtu/h	°CDB	°CWB	TC	IP	TC	IP	TC	IP	TC	IP	TC
36	-15.0	-16.0	9.63	4.50	9.17	4.50	8.80	4.50	8.62	4.49	8.43	4.48
	-10.0	-11.0	10.70	4.50	10.20	4.50	9.87	4.50	9.66	4.49	9.45	4.48
	-5.0	-7.0	11.93	4.50	11.44	4.50	11.02	4.50	10.86	4.49	10.69	4.48
	0.0	-2.0	13.76	4.50	13.24	4.50	12.71	4.50	12.40	4.48	12.10	4.45
	5.0	3.0	15.72	4.50	14.98	4.50	13.87	4.50	13.41	4.37	12.94	4.23
	7.0	6.0	16.44	4.21	15.47	4.13	14.22	4.05	13.56	3.84	12.89	3.63
	10.0	8.0	16.33	4.21	15.36	4.13	14.22	4.05	13.56	3.94	12.91	3.82
	15.0	10.0	16.30	3.96	15.26	3.89	14.22	3.77	13.62	3.66	13.01	3.54
	20.0	15.0	15.44	3.43	14.47	3.37	13.57	3.27	13.04	3.16	12.52	3.06
	24.0	18.0	14.54	3.13	13.70	3.07	12.94	2.99	12.71	2.95	12.48	2.92
35	-15.0	-16.0	9.47	4.42	9.02	4.42	8.66	4.42	8.48	4.41	8.30	4.40
	-10.0	-11.0	10.54	4.42	10.04	4.42	9.71	4.42	9.51	4.41	9.30	4.40
	-5.0	-7.0	11.75	4.42	11.26	4.42	10.85	4.42	10.69	4.41	10.52	4.40
	0.0	-2.0	13.55	4.42	13.03	4.42	12.51	4.42	12.21	4.40	11.91	4.37
	5.0	3.0	15.47	4.42	14.74	4.42	13.65	4.42	13.20	4.29	12.74	4.16
	7.0	6.0	16.19	4.14	15.23	4.06	14.00	3.98	13.34	3.78	12.69	3.57
	10.0	8.0	16.07	4.14	15.12	4.06	14.00	3.98	13.35	3.87	12.70	3.76
	15.0	10.0	16.05	3.89	15.02	3.82	14.00	3.71	13.40	3.59	12.80	3.48
	20.0	15.0	15.20	3.37	14.24	3.31	13.36	3.21	12.84	3.11	12.32	3.00
	24.0	18.0	14.31	3.08	13.48	3.02	12.74	2.93	12.51	2.90	12.29	2.87
34	-15.0	-16.0	9.20	4.29	8.77	4.29	8.42	4.29	8.24	4.28	8.06	4.27
	-10.0	-11.0	10.23	4.29	9.75	4.29	9.44	4.29	9.24	4.28	9.04	4.27
	-5.0	-7.0	11.41	4.29	10.94	4.29	10.54	4.29	10.38	4.28	10.22	4.27
	0.0	-2.0	13.16	4.29	12.66	4.29	12.16	4.29	11.86	4.27	11.57	4.25
	5.0	3.0	15.03	4.29	14.32	4.29	13.26	4.29	12.82	4.16	12.38	4.04
	7.0	6.0	15.73	4.01	14.79	3.94	13.60	3.86	12.96	3.66	12.33	3.46
	10.0	8.0	15.61	4.01	14.69	3.94	13.60	3.86	12.97	3.75	12.34	3.64
	15.0	10.0	15.59	3.78	14.60	3.70	13.60	3.60	13.02	3.49	12.44	3.38
	20.0	15.0	14.77	3.27	13.83	3.21	12.98	3.11	12.47	3.01	11.97	2.91
	24.0	18.0	13.90	2.99	13.10	2.93	12.37	2.85	12.15	2.82	11.93	2.79

OUTDOOR UNIT
AOYG45L6LA6

OUTDOOR UNIT
AOYG45L6LA6

NOTES:

- TC: Total Capacity (kW), IP: Input Power (kW)
- Values mentioned in the table are based on the following conditions:
 - Power source of specifications: 230 V
 - Pipe length: 5 m, Height difference: 0 m [Outdoor unit—Indoor unit]
- 2 or more indoor units should be connected.
- The total ability of connected a indoor unit is from 34,000 Btu up to 62,000 Btu.
- Input in the table are calculated based on the maximum indoor unit input combinations.

■ Compact cassette type

MODEL: AUYG07LVLA

Outdoor temperature		Indoor temperature (°CDB)				
		16.0	18.0	20.0	22.0	24.0
(°CDB)	(°CWB)	TC	TC	TC	TC	TC
-15.0	-16.0	1.73	1.65	1.58	1.55	1.52
-10.0	-11.0	1.93	1.84	1.78	1.74	1.70
-5.0	-7.0	2.15	2.06	1.98	1.95	1.92
0.0	-2.0	2.48	2.38	2.29	2.23	2.18
5.0	3.0	2.83	2.70	2.50	2.41	2.33
7.0	6.0	2.96	2.78	2.56	2.44	2.32
10.0	8.0	2.94	2.77	2.56	2.44	2.32
15.0	10.0	2.93	2.75	2.56	2.45	2.34
20.0	15.0	2.78	2.60	2.44	2.35	2.25
24.0	18.0	2.62	2.47	2.33	2.29	2.25

MODEL: AUYG09LVLA

Outdoor temperature		Indoor temperature (°CDB)				
		16.0	18.0	20.0	22.0	24.0
(°CDB)	(°CWB)	TC	TC	TC	TC	TC
-15.0	-16.0	2.23	2.13	2.04	2.00	1.96
-10.0	-11.0	2.48	2.37	2.29	2.24	2.19
-5.0	-7.0	2.77	2.65	2.56	2.52	2.48
0.0	-2.0	3.19	3.07	2.95	2.88	2.81
5.0	3.0	3.65	3.48	3.22	3.11	3.00
7.0	6.0	3.82	3.59	3.30	3.15	2.99
10.0	8.0	3.79	3.56	3.30	3.15	2.99
15.0	10.0	3.78	3.54	3.30	3.16	3.02
20.0	15.0	3.58	3.36	3.15	3.03	2.90
24.0	18.0	3.37	3.18	3.00	2.95	2.90

MODEL: AUYG12LVLB

Outdoor temperature		Indoor temperature (°CDB)				
		16.0	18.0	20.0	22.0	24.0
(°CDB)	(°CWB)	TC	TC	TC	TC	TC
-15.0	-16.0	2.97	2.83	2.72	2.66	2.60
-10.0	-11.0	3.30	3.15	3.05	2.98	2.92
-5.0	-7.0	3.68	3.53	3.40	3.35	3.30
0.0	-2.0	4.25	4.09	3.92	3.83	3.73
5.0	3.0	4.85	4.62	4.28	4.14	4.00
7.0	6.0	5.08	4.77	4.39	4.18	3.98
10.0	8.0	5.04	4.74	4.39	4.19	3.98
15.0	10.0	5.03	4.71	4.39	4.20	4.02
20.0	15.0	4.77	4.47	4.19	4.03	3.86
24.0	18.0	4.49	4.23	3.99	3.92	3.85

MODEL: AUYG14LVLB

Outdoor temperature		Indoor temperature (°CDB)				
		16.0	18.0	20.0	22.0	24.0
(°CDB)	(°CWB)	TC	TC	TC	TC	TC
-15.0	-16.0	3.46	3.29	3.16	3.10	3.03
-10.0	-11.0	3.85	3.67	3.55	3.47	3.39
-5.0	-7.0	4.29	4.11	3.96	3.90	3.84
0.0	-2.0	4.95	4.76	4.57	4.46	4.35
5.0	3.0	5.65	5.38	4.98	4.82	4.65
7.0	6.0	5.91	5.56	5.11	4.87	4.63
10.0	8.0	5.87	5.52	5.11	4.87	4.64
15.0	10.0	5.86	5.48	5.11	4.89	4.67
20.0	15.0	5.55	5.20	4.88	4.69	4.50
24.0	18.0	5.22	4.92	4.65	4.57	4.48

MODEL: AUYG18LVLB

Outdoor temperature		Indoor temperature (°CDB)				
		16.0	18.0	20.0	22.0	24.0
(°CDB)	(°CWB)	TC	TC	TC	TC	TC
-15.0	-16.0	4.45	4.23	4.07	3.98	3.90
-10.0	-11.0	4.94	4.71	4.56	4.46	4.36
-5.0	-7.0	5.51	5.28	5.09	5.02	4.94
0.0	-2.0	6.36	6.11	5.87	5.73	5.59
5.0	3.0	7.26	6.92	6.41	6.19	5.98
7.0	6.0	7.60	7.14	6.57	6.27	5.95
10.0	8.0	7.54	7.10	6.57	6.27	5.96
15.0	10.0	7.53	7.05	6.57	6.29	6.01
20.0	15.0	7.13	6.68	6.27	6.03	5.78
24.0	18.0	6.71	6.33	5.98	5.87	5.77

NOTES:

- TC: Total Capacity (kW)
- Values mentioned in the table are based on the following conditions:
 - Pipe length: 5 m, Height difference: 0 m [Outdoor unit—Indoor unit]

■ Mini duct type

MODEL: ARYG07LSLAP

Outdoor temperature		Indoor temperature (°CDB)				
		16.0	18.0	20.0	22.0	24.0
(°CDB)	(°CWB)	TC	TC	TC	TC	TC
-15.0	-16.0	1.73	1.65	1.58	1.55	1.52
-10.0	-11.0	1.93	1.84	1.78	1.74	1.70
-5.0	-7.0	2.15	2.06	1.98	1.95	1.92
0.0	-2.0	2.48	2.38	2.29	2.23	2.18
5.0	3.0	2.83	2.70	2.50	2.41	2.33
7.0	6.0	2.96	2.78	2.56	2.44	2.32
10.0	8.0	2.94	2.77	2.56	2.44	2.32
15.0	10.0	2.93	2.75	2.56	2.45	2.34
20.0	15.0	2.78	2.60	2.44	2.35	2.25
24.0	18.0	2.62	2.47	2.33	2.29	2.25

MODEL: ARYG09LSLAP

Outdoor temperature		Indoor temperature (°CDB)				
		16.0	18.0	20.0	22.0	24.0
(°CDB)	(°CWB)	TC	TC	TC	TC	TC
-15.0	-16.0	2.23	2.13	2.04	2.00	1.96
-10.0	-11.0	2.48	2.37	2.29	2.24	2.19
-5.0	-7.0	2.77	2.65	2.56	2.52	2.48
0.0	-2.0	3.19	3.07	2.95	2.88	2.81
5.0	3.0	3.65	3.48	3.22	3.11	3.00
7.0	6.0	3.82	3.59	3.30	3.15	2.99
10.0	8.0	3.79	3.56	3.30	3.15	2.99
15.0	10.0	3.78	3.54	3.30	3.16	3.02
20.0	15.0	3.58	3.36	3.15	3.03	2.90
24.0	18.0	3.37	3.18	3.00	2.95	2.90

MODEL: ARYG12LSLAP

Outdoor temperature		Indoor temperature (°CDB)				
		16.0	18.0	20.0	22.0	24.0
(°CDB)	(°CWB)	TC	TC	TC	TC	TC
-15.0	-16.0	2.97	2.83	2.72	2.66	2.60
-10.0	-11.0	3.30	3.15	3.05	2.98	2.92
-5.0	-7.0	3.68	3.53	3.40	3.35	3.30
0.0	-2.0	4.25	4.09	3.92	3.83	3.73
5.0	3.0	4.85	4.62	4.28	4.14	4.00
7.0	6.0	5.08	4.77	4.39	4.18	3.98
10.0	8.0	5.04	4.74	4.39	4.19	3.98
15.0	10.0	5.03	4.71	4.39	4.20	4.02
20.0	15.0	4.77	4.47	4.19	4.03	3.86
24.0	18.0	4.49	4.23	3.99	3.92	3.85

MODEL: ARYG14LSLAP

Outdoor temperature		Indoor temperature (°CDB)				
		16.0	18.0	20.0	22.0	24.0
(°CDB)	(°CWB)	TC	TC	TC	TC	TC
-15.0	-16.0	3.46	3.29	3.16	3.10	3.03
-10.0	-11.0	3.85	3.67	3.55	3.47	3.39
-5.0	-7.0	4.29	4.11	3.96	3.90	3.84
0.0	-2.0	4.95	4.76	4.57	4.46	4.35
5.0	3.0	5.65	5.38	4.98	4.82	4.65
7.0	6.0	5.91	5.56	5.11	4.87	4.63
10.0	8.0	5.87	5.52	5.11	4.87	4.64
15.0	10.0	5.86	5.48	5.11	4.89	4.67
20.0	15.0	5.55	5.20	4.88	4.69	4.50
24.0	18.0	5.22	4.92	4.65	4.57	4.48

MODEL: ARYG18LSLAP

Outdoor temperature		Indoor temperature (°CDB)				
		16.0	18.0	20.0	22.0	24.0
(°CDB)	(°CWB)	TC	TC	TC	TC	TC
-15.0	-16.0	4.45	4.23	4.07	3.98	3.90
-10.0	-11.0	4.94	4.71	4.56	4.46	4.36
-5.0	-7.0	5.51	5.28	5.09	5.02	4.94
0.0	-2.0	6.36	6.11	5.87	5.73	5.59
5.0	3.0	7.26	6.92	6.41	6.19	5.98
7.0	6.0	7.60	7.14	6.57	6.26	5.95
10.0	8.0	7.54	7.10	6.57	6.27	5.96
15.0	10.0	7.53	7.05	6.57	6.29	6.01
20.0	15.0	7.13	6.68	6.27	6.03	5.78
24.0	18.0	6.71	6.33	5.98	5.87	5.77

NOTES:

- TC: Total Capacity (kW)
- Values mentioned in the table are based on the following conditions:
 - Pipe length: 5 m, Height difference: 0 m [Outdoor unit—Indoor unit]

■ Slim duct type

MODEL: ARYG07LLTA

Outdoor temperature		Indoor temperature (°CDB)				
		16.0	18.0	20.0	22.0	24.0
(°CDB)	(°CWB)	TC	TC	TC	TC	TC
-15.0	-16.0	1.73	1.65	1.58	1.55	1.52
-10.0	-11.0	1.93	1.84	1.78	1.74	1.70
-5.0	-7.0	2.15	2.06	1.98	1.95	1.92
0.0	-2.0	2.48	2.38	2.29	2.23	2.18
5.0	3.0	2.83	2.70	2.50	2.41	2.33
7.0	6.0	2.96	2.78	2.56	2.44	2.32
10.0	8.0	2.94	2.77	2.56	2.44	2.32
15.0	10.0	2.93	2.75	2.56	2.45	2.34
20.0	15.0	2.78	2.60	2.44	2.35	2.25
24.0	18.0	2.62	2.47	2.33	2.29	2.25

MODEL: ARYG09LLTA

Outdoor temperature		Indoor temperature (°CDB)				
		16.0	18.0	20.0	22.0	24.0
(°CDB)	(°CWB)	TC	TC	TC	TC	TC
-15.0	-16.0	2.23	2.13	2.04	2.00	1.96
-10.0	-11.0	2.48	2.37	2.29	2.24	2.19
-5.0	-7.0	2.77	2.65	2.56	2.52	2.48
0.0	-2.0	3.19	3.07	2.95	2.88	2.81
5.0	3.0	3.65	3.48	3.22	3.11	3.00
7.0	6.0	3.82	3.59	3.30	3.15	2.99
10.0	8.0	3.79	3.56	3.30	3.15	2.99
15.0	10.0	3.78	3.54	3.30	3.16	3.02
20.0	15.0	3.58	3.36	3.15	3.03	2.90
24.0	18.0	3.37	3.18	3.00	2.95	2.90

MODEL: ARYG12LLTB

Outdoor temperature		Indoor temperature (°CDB)				
		16.0	18.0	20.0	22.0	24.0
(°CDB)	(°CWB)	TC	TC	TC	TC	TC
-15.0	-16.0	2.97	2.83	2.72	2.66	2.60
-10.0	-11.0	3.30	3.15	3.05	2.98	2.92
-5.0	-7.0	3.68	3.53	3.40	3.35	3.30
0.0	-2.0	4.25	4.09	3.92	3.83	3.73
5.0	3.0	4.85	4.62	4.28	4.14	4.00
7.0	6.0	5.08	4.77	4.39	4.18	3.98
10.0	8.0	5.04	4.74	4.39	4.19	3.98
15.0	10.0	5.03	4.71	4.39	4.20	4.02
20.0	15.0	4.77	4.47	4.19	4.03	3.86
24.0	18.0	4.49	4.23	3.99	3.92	3.85

MODEL: ARYG14LLTB

Outdoor temperature		Indoor temperature (°CDB)				
		16.0	18.0	20.0	22.0	24.0
(°CDB)	(°CWB)	TC	TC	TC	TC	TC
-15.0	-16.0	3.46	3.29	3.16	3.10	3.03
-10.0	-11.0	3.85	3.67	3.55	3.47	3.39
-5.0	-7.0	4.29	4.11	3.96	3.90	3.84
0.0	-2.0	4.95	4.76	4.57	4.46	4.35
5.0	3.0	5.65	5.38	4.98	4.82	4.65
7.0	6.0	5.91	5.56	5.11	4.87	4.63
10.0	8.0	5.87	5.52	5.11	4.87	4.64
15.0	10.0	5.86	5.48	5.11	4.89	4.67
20.0	15.0	5.55	5.20	4.88	4.69	4.50
24.0	18.0	5.22	4.92	4.65	4.57	4.48

MODEL: ARYG18LLTB

Outdoor temperature		Indoor temperature (°CDB)				
		16.0	18.0	20.0	22.0	24.0
(°CDB)	(°CWB)	TC	TC	TC	TC	TC
-15.0	-16.0	4.45	4.23	4.07	3.98	3.90
-10.0	-11.0	4.94	4.71	4.56	4.46	4.36
-5.0	-7.0	5.51	5.28	5.09	5.02	4.94
0.0	-2.0	6.36	6.11	5.87	5.73	5.59
5.0	3.0	7.26	6.92	6.41	6.19	5.98
7.0	6.0	7.60	7.14	6.57	6.27	5.95
10.0	8.0	7.54	7.10	6.57	6.27	5.96
15.0	10.0	7.53	7.05	6.57	6.29	6.01
20.0	15.0	7.13	6.68	6.27	6.03	5.78
24.0	18.0	6.71	6.33	5.98	5.87	5.77

NOTES:

- TC: Total Capacity (kW)
- Values mentioned in the table are based on the following conditions:
 - Pipe length: 5 m, Height difference: 0 m [Outdoor unit—Indoor unit]

■ Wall mounted type

MODELS: ASYG07LMCA, ASYG07LMCE, and ASYG07LUCA

Outdoor temperature		Indoor temperature (°CDB)				
		16.0	18.0	20.0	22.0	24.0
(°CDB)	(°CWB)	TC	TC	TC	TC	TC
-15.0	-16.0	1.73	1.65	1.58	1.55	1.52
-10.0	-11.0	1.93	1.84	1.78	1.74	1.70
-5.0	-7.0	2.15	2.06	1.98	1.95	1.92
0.0	-2.0	2.48	2.38	2.29	2.23	2.18
5.0	3.0	2.83	2.70	2.50	2.41	2.33
7.0	6.0	2.96	2.78	2.56	2.44	2.32
10.0	8.0	2.94	2.77	2.56	2.44	2.32
15.0	10.0	2.93	2.75	2.56	2.45	2.34
20.0	15.0	2.78	2.60	2.44	2.35	2.25
24.0	18.0	2.62	2.47	2.33	2.29	2.25

MODELS: ASYG09LMCA, ASYG09LMCE, and ASYG09LUCA

Outdoor temperature		Indoor temperature (°CDB)				
		16.0	18.0	20.0	22.0	24.0
(°CDB)	(°CWB)	TC	TC	TC	TC	TC
-15.0	-16.0	2.23	2.13	2.04	2.00	1.96
-10.0	-11.0	2.48	2.37	2.29	2.24	2.19
-5.0	-7.0	2.77	2.65	2.56	2.52	2.48
0.0	-2.0	3.19	3.07	2.95	2.88	2.81
5.0	3.0	3.65	3.48	3.22	3.11	3.00
7.0	6.0	3.82	3.59	3.30	3.15	2.99
10.0	8.0	3.79	3.56	3.30	3.15	2.99
15.0	10.0	3.78	3.54	3.30	3.16	3.02
20.0	15.0	3.58	3.36	3.15	3.03	2.90
24.0	18.0	3.37	3.18	3.00	2.95	2.90

MODELS: ASYG12LMCA, ASYG12LMCE, and ASYG12LUCA

Outdoor temperature		Indoor temperature (°CDB)				
		16.0	18.0	20.0	22.0	24.0
(°CDB)	(°CWB)	TC	TC	TC	TC	TC
-15.0	-16.0	2.97	2.83	2.72	2.66	2.60
-10.0	-11.0	3.30	3.15	3.05	2.98	2.92
-5.0	-7.0	3.68	3.53	3.40	3.35	3.30
0.0	-2.0	4.25	4.09	3.92	3.83	3.73
5.0	3.0	4.85	4.62	4.28	4.14	4.00
7.0	6.0	5.08	4.77	4.39	4.18	3.98
10.0	8.0	5.04	4.74	4.39	4.19	3.98
15.0	10.0	5.03	4.71	4.39	4.20	4.02
20.0	15.0	4.77	4.47	4.19	4.03	3.86
24.0	18.0	4.49	4.23	3.99	3.92	3.85

MODELS: ASYG14LMCA, ASYG14LMCE, and ASYG14LUCA

Outdoor temperature		Indoor temperature (°CDB)				
		16.0	18.0	20.0	22.0	24.0
(°CDB)	(°CWB)	TC	TC	TC	TC	TC
-15.0	-16.0	3.46	3.29	3.16	3.10	3.03
-10.0	-11.0	3.85	3.67	3.55	3.47	3.39
-5.0	-7.0	4.29	4.11	3.96	3.90	3.84
0.0	-2.0	4.95	4.76	4.57	4.46	4.35
5.0	3.0	5.65	5.38	4.98	4.82	4.65
7.0	6.0	5.91	5.56	5.11	4.87	4.63
10.0	8.0	5.87	5.52	5.11	4.87	4.64
15.0	10.0	5.86	5.48	5.11	4.89	4.67
20.0	15.0	5.55	5.20	4.88	4.69	4.50
24.0	18.0	5.22	4.92	4.65	4.57	4.48

MODEL: ASYG18LFCA

Outdoor temperature		Indoor temperature (°CDB)				
		16.0	18.0	20.0	22.0	24.0
(°CDB)	(°CWB)	TC	TC	TC	TC	TC
-15.0	-16.0	4.45	4.23	4.07	3.98	3.90
-10.0	-11.0	4.94	4.71	4.56	4.46	4.36
-5.0	-7.0	5.51	5.28	5.09	5.02	4.94
0.0	-2.0	6.36	6.11	5.87	5.73	5.59
5.0	3.0	7.26	6.92	6.41	6.19	5.98
7.0	6.0	7.60	7.14	6.57	6.26	5.95
10.0	8.0	7.54	7.10	6.57	6.27	5.96
15.0	10.0	7.53	7.05	6.57	6.29	6.01
20.0	15.0	7.13	6.68	6.27	6.03	5.78
24.0	18.0	6.71	6.33	5.98	5.87	5.77

MODELS: ASYG24LFCA and ASYG24LFCC

Outdoor temperature		Indoor temperature (°CDB)				
		16.0	18.0	20.0	22.0	24.0
(°CDB)	(°CWB)	TC	TC	TC	TC	TC
-15.0	-16.0	5.91	5.63	5.41	5.30	5.18
-10.0	-11.0	6.58	6.27	6.06	5.93	5.81
-5.0	-7.0	7.33	7.03	6.77	6.67	6.57
0.0	-2.0	8.46	8.13	7.81	7.62	7.43
5.0	3.0	9.66	9.20	8.52	8.24	7.95
7.0	6.0	10.11	9.50	8.74	8.33	7.92
10.0	8.0	10.03	9.44	8.74	8.34	7.93
15.0	10.0	10.02	9.38	8.74	8.37	7.99
20.0	15.0	9.49	8.89	8.34	8.02	7.69
24.0	18.0	8.93	8.42	7.95	7.81	7.67

NOTES:

- TC: Total Capacity (kW)
- Values mentioned in the table are based on the following conditions:
 - Pipe length: 5 m, Height difference: 0 m [Outdoor unit—Indoor unit]

■ Floor/Ceiling type

MODEL: ABYG14LVTA

Outdoor temperature		Indoor temperature (°CDB)				
		16.0	18.0	20.0	22.0	24.0
(°CDB)	(°CWB)	TC	TC	TC	TC	TC
-15.0	-16.0	3.46	3.29	3.16	3.10	3.03
-10.0	-11.0	3.85	3.67	3.55	3.47	3.39
-5.0	-7.0	4.29	4.11	3.96	3.90	3.84
0.0	-2.0	4.95	4.76	4.57	4.46	4.35
5.0	3.0	5.65	5.38	4.98	4.82	4.65
7.0	6.0	5.91	5.56	5.11	4.87	4.63
10.0	8.0	5.87	5.52	5.11	4.87	4.64
15.0	10.0	5.86	5.48	5.11	4.89	4.67
20.0	15.0	5.55	5.20	4.88	4.69	4.50
24.0	18.0	5.22	4.92	4.65	4.57	4.48

MODEL: ABYG18LVTB

Outdoor temperature		Indoor temperature (°CDB)				
		16.0	18.0	20.0	22.0	24.0
(°CDB)	(°CWB)	TC	TC	TC	TC	TC
-15.0	-16.0	4.45	4.23	4.07	3.98	3.90
-10.0	-11.0	4.94	4.71	4.56	4.46	4.36
-5.0	-7.0	5.51	5.28	5.09	5.02	4.94
0.0	-2.0	6.36	6.11	5.87	5.73	5.59
5.0	3.0	7.26	6.92	6.41	6.19	5.98
7.0	6.0	7.60	7.14	6.57	6.26	5.95
10.0	8.0	7.54	7.10	6.57	6.27	5.96
15.0	10.0	7.53	7.05	6.57	6.29	6.01
20.0	15.0	7.13	6.68	6.27	6.03	5.78
24.0	18.0	6.71	6.33	5.98	5.87	5.77

NOTES:

- TC: Total Capacity (kW)
- Values mentioned in the table are based on the following conditions:
 - Pipe length: 5 m, Height difference: 0 m [Outdoor unit—Indoor unit]

■ Floor type

MODEL: AGYG09LVCA

Outdoor temperature		Indoor temperature (°CDB)				
		16.0	18.0	20.0	22.0	24.0
(°CDB)	(°CWB)	TC	TC	TC	TC	TC
-15.0	-16.0	2.23	2.13	2.04	2.00	1.96
-10.0	-11.0	2.48	2.37	2.29	2.24	2.19
-5.0	-7.0	2.77	2.65	2.56	2.52	2.48
0.0	-2.0	3.19	3.07	2.95	2.88	2.81
5.0	3.0	3.65	3.48	3.22	3.11	3.00
7.0	6.0	3.82	3.59	3.30	3.15	2.99
10.0	8.0	3.79	3.56	3.30	3.15	2.99
15.0	10.0	3.78	3.54	3.30	3.16	3.02
20.0	15.0	3.58	3.36	3.15	3.03	2.90
24.0	18.0	3.37	3.18	3.00	2.95	2.90

MODEL: AGYG12LVCA

Outdoor temperature		Indoor temperature (°CDB)				
		16.0	18.0	20.0	22.0	24.0
(°CDB)	(°CWB)	TC	TC	TC	TC	TC
-15.0	-16.0	2.97	2.83	2.72	2.66	2.60
-10.0	-11.0	3.30	3.15	3.05	2.98	2.92
-5.0	-7.0	3.68	3.53	3.40	3.35	3.30
0.0	-2.0	4.25	4.09	3.92	3.83	3.73
5.0	3.0	4.85	4.62	4.28	4.14	4.00
7.0	6.0	5.08	4.77	4.39	4.18	3.98
10.0	8.0	5.04	4.74	4.39	4.19	3.98
15.0	10.0	5.03	4.71	4.39	4.20	4.02
20.0	15.0	4.77	4.47	4.19	4.03	3.86
24.0	18.0	4.49	4.23	3.99	3.92	3.85

MODEL: AGYG14LVCA

Outdoor temperature		Indoor temperature (°CDB)				
		16.0	18.0	20.0	22.0	24.0
(°CDB)	(°CWB)	TC	TC	TC	TC	TC
-15.0	-16.0	3.46	3.29	3.16	3.10	3.03
-10.0	-11.0	3.85	3.67	3.55	3.47	3.39
-5.0	-7.0	4.29	4.11	3.96	3.90	3.84
0.0	-2.0	4.95	4.76	4.57	4.46	4.35
5.0	3.0	5.65	5.38	4.98	4.82	4.65
7.0	6.0	5.91	5.56	5.11	4.87	4.63
10.0	8.0	5.87	5.52	5.11	4.87	4.64
15.0	10.0	5.86	5.48	5.11	4.89	4.67
20.0	15.0	5.55	5.20	4.88	4.69	4.50
24.0	18.0	5.22	4.92	4.65	4.57	4.48

NOTES:

- TC: Total Capacity (kW)
- Values mentioned in the table are based on the following conditions:
 - Pipe length: 5 m, Height difference: 0 m [Outdoor unit—Indoor unit]

7. Capacity compensation rate for pipe length and height difference

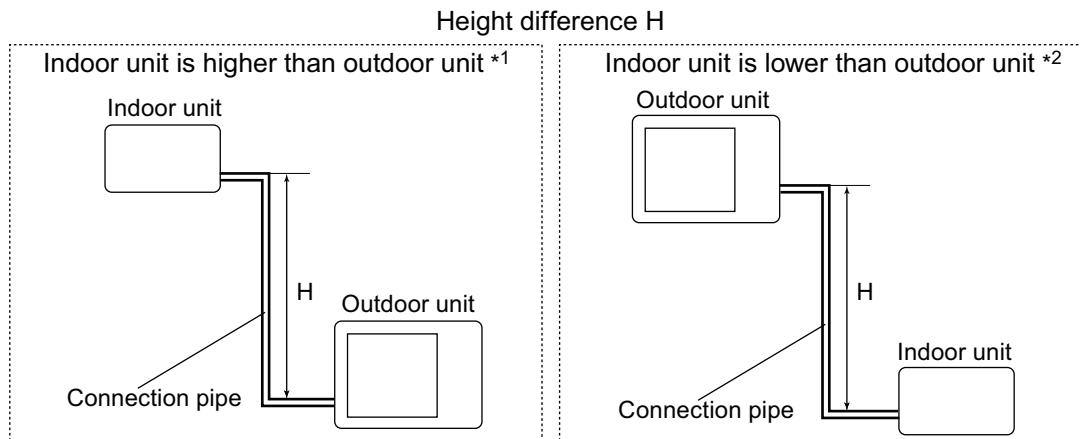

OUTDOOR UNIT
AOYG45LBLA6

OUTDOOR UNIT
AOYG45LBLA6

7-1. Model: AOYG45LBLA6

NOTE: Values mentioned in the table are calculated based on the maximum capacity.

■ Indoor unit: 7,000 Btu

COOLING		Pipe length						
		m	5	7.5	10	15	20	25
Height difference H (m)	Indoor unit is higher than outdoor unit *1	15	—	—	—	0.955	0.941	0.927
		10	—	—	0.976	0.962	0.949	0.935
		7.5	—	0.988	0.980	0.966	0.952	0.939
		5	0.992	0.992	0.984	0.970	0.956	0.942
		0	1.000	1.000	0.992	0.978	0.964	0.950
	Indoor unit is lower than outdoor unit *2	-5	1.000	1.000	0.992	0.978	0.964	0.950
		-7.5	—	1.000	0.992	0.978	0.964	0.950
		-10	—	—	0.992	0.978	0.964	0.950
		-15	—	—	—	0.978	0.964	0.950

HEATING		Pipe length						
		m	5	7.5	10	15	20	25
Height difference H (m)	Indoor unit is higher than outdoor unit *1	15	—	—	—	0.976	0.957	0.938
		10	—	—	0.991	0.976	0.957	0.938
		7.5	—	1.000	0.991	0.976	0.957	0.938
		5	1.000	1.000	0.991	0.976	0.957	0.938
		0	1.000	1.000	0.991	0.976	0.957	0.938
	Indoor unit is lower than outdoor unit *2	-5	0.995	0.995	0.986	0.971	0.952	0.933
		-7.5	—	0.993	0.984	0.969	0.950	0.931
		-10	—	—	0.981	0.966	0.947	0.929
		-15	—	—	—	0.961	0.943	0.924

■ Indoor unit: 9,000 Btu

COOLING		Pipe length						
		m	5	7.5	10	15	20	25
Height difference H (m)	Indoor unit is higher than outdoor unit *1	15	—	—	—	0.956	0.942	0.928
		10	—	—	0.977	0.963	0.950	0.936
		7.5	—	0.988	0.981	0.967	0.954	0.940
		5	0.992	0.992	0.985	0.971	0.957	0.943
		0	1.000	1.000	0.993	0.979	0.965	0.951
	Indoor unit is lower than outdoor unit *2	-5	1.000	1.000	0.993	0.979	0.965	0.951
		-7.5	—	1.000	0.993	0.979	0.965	0.951
		-10	—	—	0.993	0.979	0.965	0.951
		-15	—	—	—	0.979	0.965	0.951

HEATING		Pipe length						
		m	5	7.5	10	15	20	25
Height difference H (m)	Indoor unit is higher than outdoor unit *1	15	—	—	—	0.977	0.958	0.939
		10	—	—	0.993	0.977	0.958	0.939
		7.5	—	1.000	0.993	0.977	0.958	0.939
		5	1.000	1.000	0.993	0.977	0.958	0.939
		0	1.000	1.000	0.993	0.977	0.958	0.939
	Indoor unit is lower than outdoor unit *2	-5	0.995	0.995	0.988	0.972	0.954	0.934
		-7.5	—	0.993	0.986	0.970	0.952	0.932
		-10	—	—	0.983	0.967	0.949	0.930
		-15	—	—	—	0.962	0.944	0.925

■ Indoor unit: 12,000 Btu

COOLING		Pipe length						
		m	5	7.5	10	15	20	25
Height difference H (m)	Indoor unit is higher than outdoor unit *1	15	—	—	—	0.937	0.912	0.888
		10	—	—	0.970	0.944	0.919	0.896
		7.5	—	0.988	0.974	0.948	0.923	0.899
		5	0.992	0.992	0.978	0.952	0.927	0.903
		0	1.000	1.000	0.986	0.960	0.934	0.910
	Indoor unit is lower than outdoor unit *2	-5	1.000	1.000	0.986	0.960	0.934	0.910
		-7.5	—	1.000	0.986	0.960	0.934	0.910
		-10	—	—	0.986	0.960	0.934	0.910
		-15	—	—	—	0.960	0.934	0.910

HEATING		Pipe length						
		m	5	7.5	10	15	20	25
Height difference H (m)	Indoor unit is higher than outdoor unit *1	15	—	—	—	0.977	0.958	0.938
		10	—	—	0.993	0.977	0.958	0.938
		7.5	—	1.000	0.993	0.977	0.958	0.938
		5	1.000	1.000	0.993	0.977	0.958	0.938
		0	1.000	1.000	0.993	0.977	0.958	0.938
	Indoor unit is lower than outdoor unit *2	-5	0.995	0.995	0.988	0.972	0.953	0.933
		-7.5	—	0.993	0.986	0.970	0.952	0.932
		-10	—	—	0.983	0.967	0.949	0.929
		-15	—	—	—	0.962	0.944	0.924

■ Indoor unit: 14,000 Btu

COOLING		Pipe length						
		m	5	7.5	10	15	20	25
Height difference H (m)	Indoor unit is higher than outdoor unit *1	15	—	—	—	0.955	0.937	0.922
		10	—	—	0.974	0.962	0.945	0.930
		7.5	—	0.988	0.978	0.966	0.948	0.934
		5	0.992	0.992	0.982	0.970	0.952	0.937
	Indoor unit is lower than outdoor unit *2	0	1.000	1.000	0.990	0.978	0.960	0.945
		-5	1.000	1.000	0.990	0.978	0.960	0.945
		-7.5	—	1.000	0.990	0.978	0.960	0.945
		-10	—	—	0.990	0.978	0.960	0.945
		-15	—	—	—	0.978	0.960	0.945

HEATING		Pipe length						
		m	5	7.5	10	15	20	25
Height difference H (m)	Indoor unit is higher than outdoor unit *1	15	—	—	—	0.972	0.945	0.919
		10	—	—	0.992	0.972	0.945	0.919
		7.5	—	1.000	0.992	0.972	0.945	0.919
		5	1.000	1.000	0.992	0.972	0.945	0.919
	Indoor unit is lower than outdoor unit *2	0	1.000	1.000	0.992	0.972	0.945	0.919
		-5	0.995	0.995	0.987	0.967	0.940	0.914
		-7.5	—	0.993	0.985	0.965	0.938	0.912
		-10	—	—	0.982	0.962	0.935	0.910
		-15	—	—	—	0.957	0.930	0.905

■ Indoor unit: 18,000 Btu

COOLING		Pipe length						
		m	5	7.5	10	15	20	25
Height difference H (m)	Indoor unit is higher than outdoor unit *1	15	—	—	—	0.968	0.961	0.954
		10	—	—	0.982	0.976	0.969	0.962
		7.5	—	0.988	0.986	0.980	0.973	0.966
		5	0.992	0.992	0.990	0.984	0.977	0.970
	Indoor unit is lower than outdoor unit *2	0	1.000	1.000	0.998	0.992	0.985	0.978
		-5	1.000	1.000	0.998	0.992	0.985	0.978
		-7.5	—	1.000	0.998	0.992	0.985	0.978
		-10	—	—	0.998	0.992	0.985	0.978
		-15	—	—	—	0.992	0.985	0.978

HEATING		Pipe length						
		m	5	7.5	10	15	20	25
Height difference H (m)	Indoor unit is higher than outdoor unit *1	15	—	—	—	0.967	0.943	0.917
		10	—	—	0.990	0.967	0.943	0.917
		7.5	—	1.000	0.990	0.967	0.943	0.917
		5	1.000	1.000	0.990	0.967	0.943	0.917
	Indoor unit is lower than outdoor unit *2	0	1.000	1.000	0.990	0.967	0.943	0.917
		-5	0.995	0.995	0.985	0.962	0.938	0.912
		-7.5	—	0.993	0.983	0.960	0.936	0.910
		-10	—	—	0.980	0.958	0.933	0.908
		-15	—	—	—	0.953	0.929	0.903

■ Indoor unit: 24,000 Btu

COOLING		Pipe length						
		m	5	7.5	10	15	20	25
Height difference H (m)	Indoor unit is higher than outdoor unit *1	15	—	—	—	0.978	0.969	0.953
		10	—	—	0.986	0.986	0.977	0.961
		7.5	—	0.988	0.990	0.990	0.981	0.965
		5	0.992	0.992	0.994	0.994	0.984	0.968
	Indoor unit is lower than outdoor unit *2	0	1.000	1.000	1.002	1.002	0.992	0.976
		-5	1.000	1.000	1.002	1.002	0.992	0.976
		-7.5	—	1.000	1.002	1.002	0.992	0.976
		-10	—	—	1.002	1.002	0.992	0.976
		-15	—	—	—	1.002	0.992	0.976

HEATING		Pipe length						
		m	5	7.5	10	15	20	25
Height difference H (m)	Indoor unit is higher than outdoor unit *1	15	—	—	—	0.964	0.939	0.913
		10	—	—	0.988	0.964	0.939	0.913
		7.5	—	1.000	0.988	0.964	0.939	0.913
		5	1.000	1.000	0.988	0.964	0.939	0.913
	Indoor unit is lower than outdoor unit *2	0	1.000	1.000	0.988	0.964	0.939	0.913
		-5	0.995	0.995	0.983	0.959	0.934	0.909
		-7.5	—	0.993	0.981	0.957	0.932	0.907
		-10	—	—	0.978	0.954	0.929	0.904
		-15	—	—	—	0.949	0.925	0.899

OUTDOOR UNIT
AOYG45LBLA6

OUTDOOR UNIT
AOYG45LBLA6

8. Additional charge calculation

8-1. Model: AOYG45LBLA6

Refrigerant type				R410A
Refrigerant amount	g	4,000		

■ Refrigerant charge

Total pipe length	m	50 or less	60	70	80 (Max.)	20 g/m
Additional charge	g	0	200	400	600	

9. Airflow

9-1. Model: AOYG45LBLA6

● Cooling

m ³ /h	4,200
l/s	1,167
CFM	2,472

● Heating

m ³ /h	4,200
l/s	1,167
CFM	2,472

10. Operation noise (sound pressure)

10-1. Noise level curve

Model: AOYG45LBLA6

● Cooling

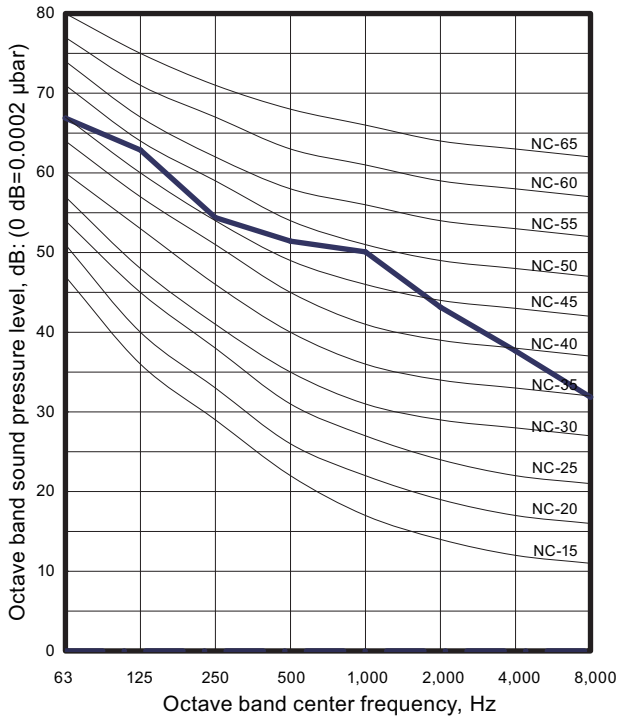

● Heating

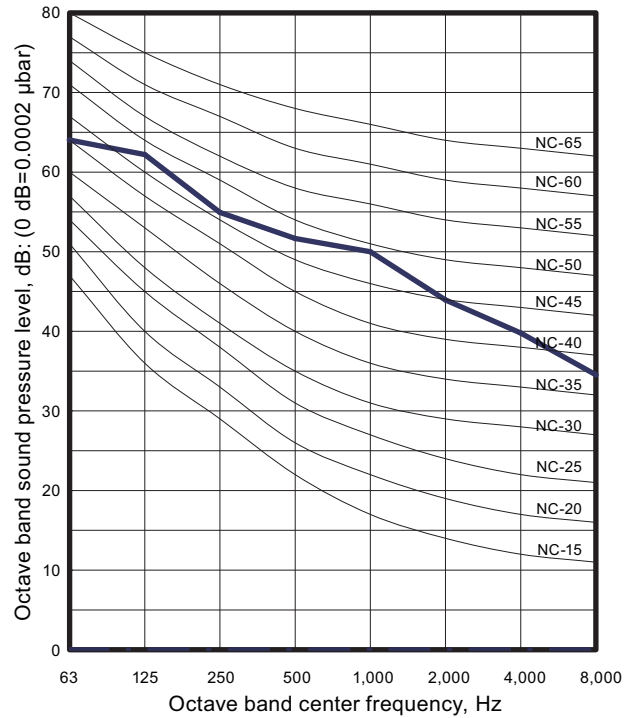

OUTDOOR UNIT
AOYG45LBLA6

OUTDOOR UNIT
AOYG45LBLA6

10-2. Sound level check point

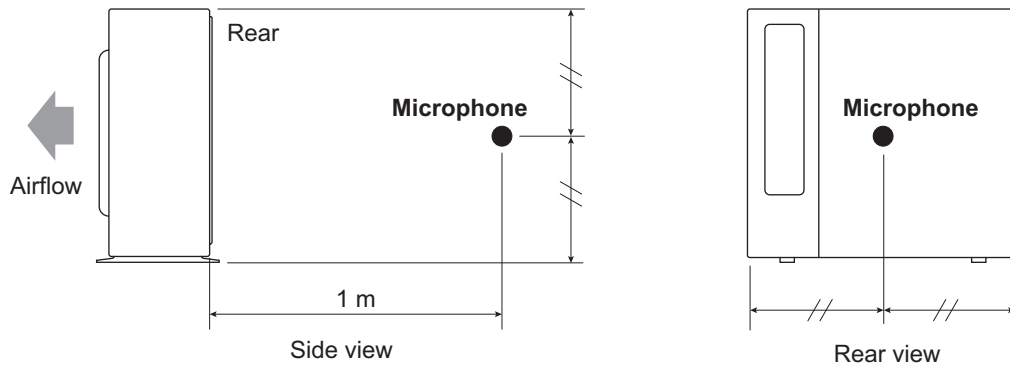

NOTE: Detailed shape of the actual outdoor unit might be slightly different from the one illustrated above.

11. Electrical characteristics

Model name			AOYG45LBLA6
Power supply	Voltage	V	230 ~
	Frequency	Hz	50
Maximum operating current		A	24.0
Starting current		A	15.7
Wiring spec. *	CKT. BKR	A	30
	Power cable	mm ²	6.0

*: Selected sample based on Japan Electrotechnical Standards and Codes Committee E0005. As the regulations of wire size and circuit breaker differ in each country or region, select appropriate devices complied to the regional standard.

CKT. BKR: Circuit Breaker

12. Safety devices

Type of protection	Protection form		Model
			AOYG45LBLA6
Circuit protection	Current fuse (PCB)		250 V, 10 A 250 V, 5 A 400 V, 5 A 250 V, 3.15 A
	Protector (PCB)		500 V, 45 A
Fan motor protection	Thermal protection program		Activate 115±15 °C Fan motor stop
			Reset 70 °C Fan motor restart
Compressor protection	Thermal protection program (Compressor temp.)		Activate 108 °C Compressor stop
			Reset 80 °C Compressor restart
	Thermal protection program (Discharge temp.)		Activate 110 °C Compressor stop
			Reset After 3 minutes and 110 °C less than Compressor restart

13. Function settings

13-1. Setting methods

⚠ WARNING

Never touch electrical components such as the terminal blocks or reactor except the switch on the display board. It may cause a serious accident such as electric shock.

⚠ CAUTION

- Once refrigerant charging is completed, be sure to open the valve prior to performing the local settings. Otherwise, the compressor may fail.
- Discharge any static electricity from your body before touching the push switches. Never touch any terminal or pattern of any parts on the control board.

The positions of the switches on the outdoor unit control board are shown in the figure below.

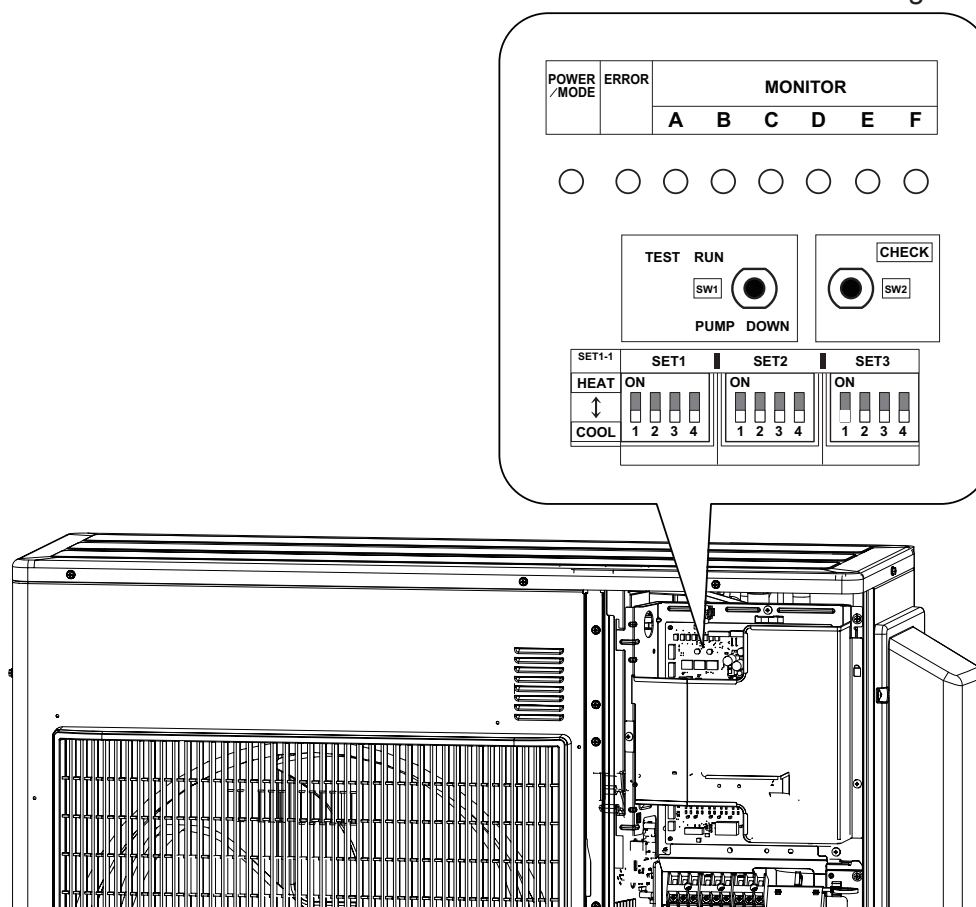

■ Setting method

1. Be sure to disconnect the power supply or turn off the breaker.
2. Change the DIP switch setting according to the required setting.
 - Various settings can be adjusted by changing DIP switches and push switches on the board of the outdoor unit.
 - The printed characters for the LED display are shown below.

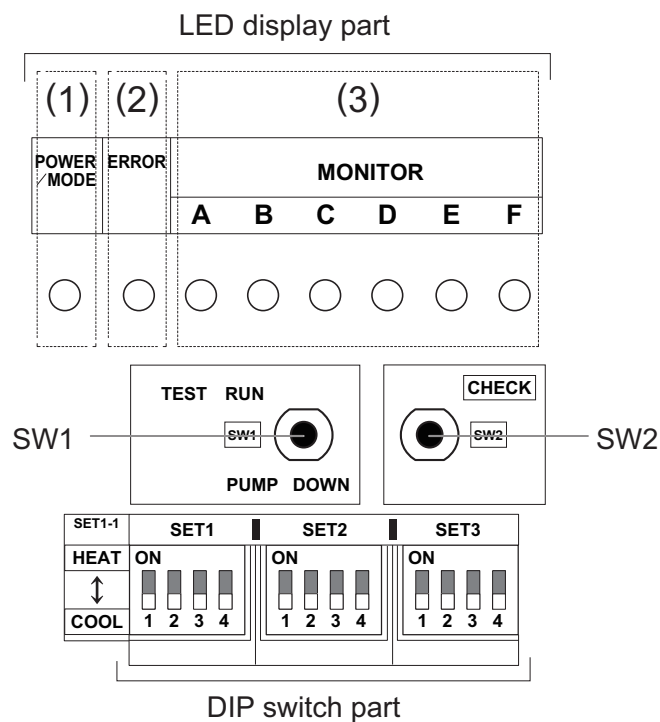

■ Description of display

LED display lamp			Function or operation method
(1)	POWER/MODE	Green	<ul style="list-style-type: none"> Turns on when the power supply is ON (Including when error occurs). Indicate the MODE by the number of flashes when the installation function is active.
(2)	ERROR	Red	Flashes at high-speed when there is an error.
(3)	MONITOR	A	<ul style="list-style-type: none"> Displays the location and contents of errors when there is an error. (Refer to Chapter 14-3. "Error code" on page 336 for details.) Displays when check run is activated. (Refer to Chapter 14-1. "Check run" on page 329 for details.)
		B	
		C	
		D	
		E	
		F	

Switch		Function or operation method	Factory setting
SW1	Push	<ul style="list-style-type: none"> For the test run start and stop. For the pump down start and stop. 	—
SW2	Push	<ul style="list-style-type: none"> For when check run function is activated. For displaying the check run. For resetting the Automatic wiring correction memory. 	—
SET1-1	DIP	For selecting cooling or heating during test operation.	OFF
SET1-2	DIP	For switching SW1 operation.	OFF
SET1-3	DIP	(Prohibited)	OFF (Do not change)
SET1-4	DIP	(Prohibited)	OFF (Do not change)
SET2-1	DIP	<ul style="list-style-type: none"> For selecting outdoor unit low noise operation function. To use this function, the Central remote controller (option) is necessary. 	OFF
SET2-2	DIP	(Prohibited)	OFF (Do not change)
SET2-3	DIP	Changing the current limit	OFF
SET2-4	DIP		
SET3-1	DIP	(Prohibited)	OFF (Do not change)
SET3-2	DIP	(Prohibited)	OFF (Do not change)
SET3-3	DIP	(Prohibited)	OFF (Do not change)
SET3-4	DIP	(Prohibited)	OFF (Do not change)

Be sure to disconnect the power supply or turn off the breaker before changing the DIP switch setting.

13-2. Outdoor unit low noise operation function (option)

Change the outdoor unit low noise operation by using this setting. Optional Central remote controller is necessary to use this function.

SET2-1	Setting	Factory setting
ON	Lower	
OFF	Low	◆

⚠ CAUTION

- When the low noise operation function is working, cooling and heating capacity will decrease.
- When changing the settings, explain to the customer beforehand that the capacity decreases.

13-3. Changing the current limit function

Change the outdoor unit current limit function by using this setting.

SET2-3	SET2-4	Current	Factory setting
OFF	OFF	Full	◆
ON	OFF	20.5 A	
OFF	ON	16.5 A	

⚠ CAUTION

- When the current limited function is working, cooling and heating capacity will decrease.
- When changing the settings, explain to the customer beforehand that the capacity decreases.

14. Check and test

14-1. Check run

- The check run is a function to screen and detect any wiring errors.
- After carrying out the check run, you can use the automatic wiring correction function to correct the wiring.
- Normal operation is possible without using the check run. In this case, use the test run or forced cooling function of the indoor unit to confirm any wiring errors.

■ Things to confirm before starting the check run

To ensure safety, check that the following work, inspections and operations have been completed.

	Check item	Check column
1	Check that all work on the piping connecting the outdoor unit, indoor units has been completed.	
2	Check that all work on the wiring connecting the outdoor unit, indoor units has been completed.	
3	Is there a gas leakage? (At pipe connections [flange connections and brazed areas])	
4	Is the system charged with the specified volume of refrigerant?	
5	Is a breaker installed at the power supply cable of outdoor unit?	
6	Are the wires connected to the terminals without looseness, and in accordance with the specifications?	
7	Is the 3-way valve of the outdoor unit open? (Gas pipe and liquid pipe)	
8	Is the power supply connected for more than 12 hours?	

■ Restrictions applicable when performing the check run

- When the check run starts, all indoor units connected to the outdoor unit will start to run automatically. During the check run, you cannot check the operation of the indoor units separately. After the check run, check the operation of the indoor units separately in normal operation.
- The check run can be used when the temperature is within the operable temperature of the air conditioner.
- In the check run, the air conditioner will automatically switch between cooling and heating depending on the external temperature and internal temperature.
- The check run can be completed in about 30 minutes (cooling) or about 1 hour (heating), but may take more depending on the external and internal temperature conditions etc.
- Do not conduct the check run with all the windows in the room closed. Otherwise the room temperature could get too low or too high.
- Depending on the difference of the room temperature of each room, a judgment may be impossible.
- Check run is a special operation so there may be a noise louder than the normal refrigerant noise or a creaking noise.

■ Operating procedure for check run

⚠ CAUTION

Initiate check run after more than 12 hours after the power supply is connected.

NOTE: Be sure that the indoor unit and outdoor unit are not operating before starting the check run.

1. Press the "CHECK" switch for 3 seconds or more.

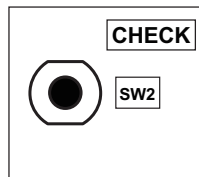

2. The number of indoor units (and the places) connected through the communication lines is displayed.
 - If the displayed number of units (places) and the installed number of units (places) is the same, proceed to step 3.
 - If the displayed number of units (places) and the installed number of units (places) is not the same, shut off the power and check whether the indoor and outdoor communication lines are properly connected.
 - If there is no operation for 1 minute, the LED will return to the original display. (POWER/MODE LED: ON)

Example: When 4 indoor units (A to D) are connected

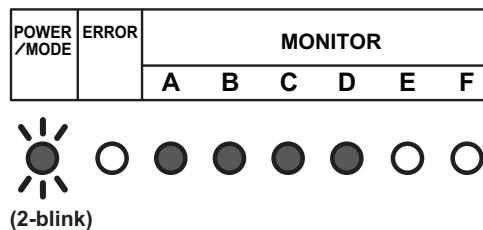

3. Press the "CHECK" switch for 3 seconds or more again. Check run is initiated.
 - When check run is initiated, all LEDs from A to F will flash. (Preliminary operation)
 - The LED for each indoor unit will switch off in order as check for each unit is completed.

NOTE: To interrupt the check run, press the "CHECK" switch.

Example: When 4 indoor units (A to D) are connected

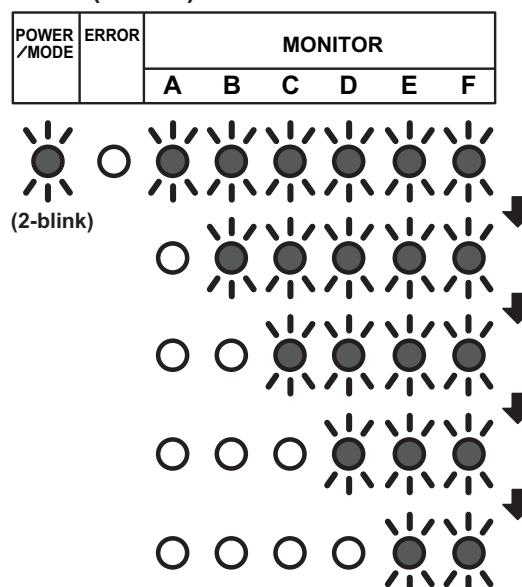

4. After the check run is completed, results will be displayed. Fill the displayed results in the result table accordingly.

• **If the connection is correct (Example: When 4 indoor units are connected)**

After the number of connected units are displayed, the LED for each unit will light up in order from A to D.

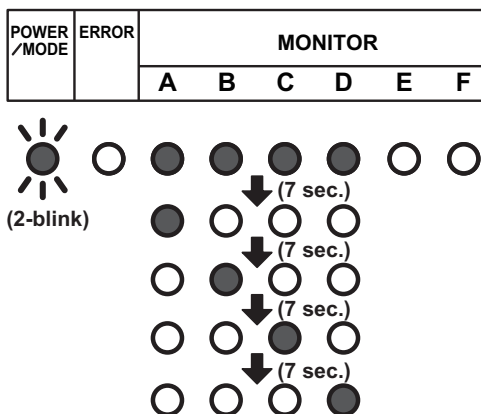

• **If the connection is incorrect (Example: When connection of B and C of the 4 units are reversed)**

After the number of connected units are displayed, B and C will light up in reverse.

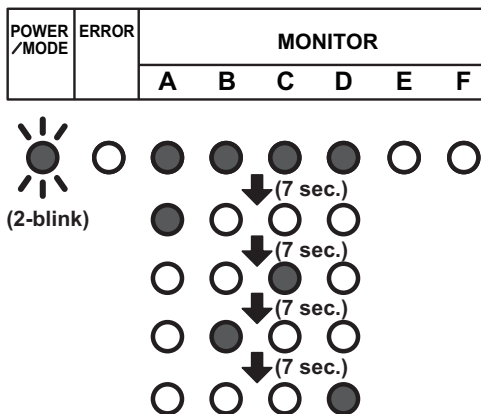

NOTES:

- Automatic wiring correction will not be completed if the power supply is disconnected while displaying the results. To confirm the automatic wiring correction, be sure to carry out step 5.
- If frost is formed on the outdoor unit while displaying the results, automatic defrost function will be operated. Proceed to step 5 after the defrost function is finished.

[How to record the contents]

- Fill the displayed results according to the following example.

Example: When piping A to D is connected but the wires for B and C are connected in reverse.

<Displayed results>

The LEDs will light up in 7 second intervals in the following order.

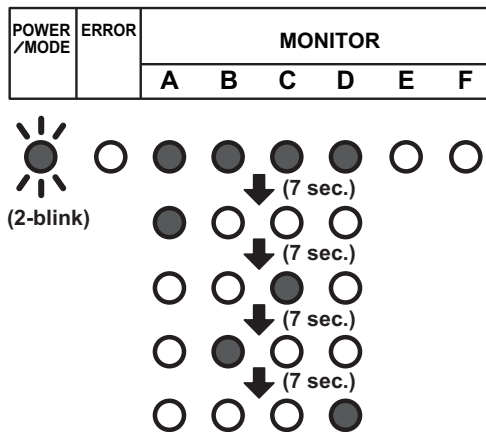

<Example of result table>

- Please write a ● where the LEDs light up in the order that they light up.

	A	B	C	D	E	F
1	●	●	●	●	○	○
2	●	○	○	○	○	○
3	○	○	●	○	○	○
4	○	●	○	○	○	○
5	○	○	○	●	○	○
6	○	○	○	○	○	○
7	○	○	○	○	○	○

- Based on the results of step (a), please record as follows.

- Trace the dotted circle with a pen if multiple places light up.

A	B	C	D	E	F
○	○	○	○	⋯	⋯

- Write the order from A to D in which the LEDs lit up inside the circle.

A	B	C	D	E	F
Ⓐ	Ⓒ	Ⓑ	Ⓓ	⋯	⋯

- Select the correction method.

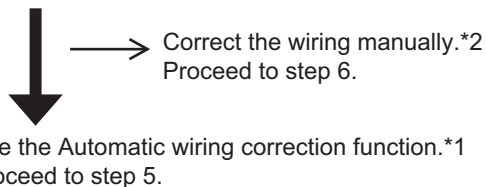

Write down the same results in the label on the reverse side of the service panel.

The results recorded are needed at the time of servicing.

NOTES:

- *1: By using this function, the wiring is automatically corrected according to the piping.
- *2: When correcting the wiring manually, please disconnect the power supply or turn off the breaker during results display, and then change the wiring manually according to the obtained test results.

For example, in Example 1, the wirings connected to the terminals B and C is to be exchanged manually.

<Result Table>

	A	B	C	D	E	F
1	○	○	○	○	○	○
2	○	○	○	○	○	○
3	○	○	○	○	○	○
4	○	○	○	○	○	○
5	○	○	○	○	○	○
6	○	○	○	○	○	○
7	○	○	○	○	○	○

A	B	C	D	E	F
○	○	○	○	○	○

5. During results display, press the "CHECK" switch for 3 seconds or more. After LEDs A to F have lit in turn, all LEDs will light up indicating that the automatic wiring correction is completed.

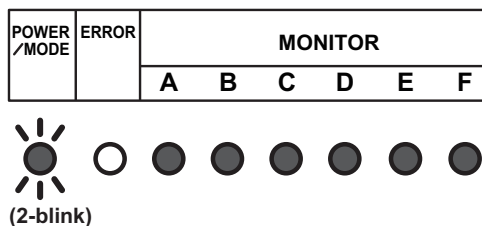

6. Disconnect the power supply or turn off the breaker and wait 10 minutes then turn the power back on and perform test run.

NOTE: If you do not disconnect the power supply or turn off the breaker, normal operation is not possible.

Notices:

- If an error occurs during check run it will be suspended. Correct the error and start check run again.
- After the check run, if automatic wiring correction is carried out, the indoor unit's position will be modified to match the piping. (Note that the display of the optional remote controller changes.)
- If you start check run again after the automatic wiring correction is finished, the modification will be reset.

■ Check run judgment failure display

If check run cannot be performed, the following is displayed. In this case, the check run will stop. Please check by using the cooling test run of the indoor unit.

● Temperature out of range judgment

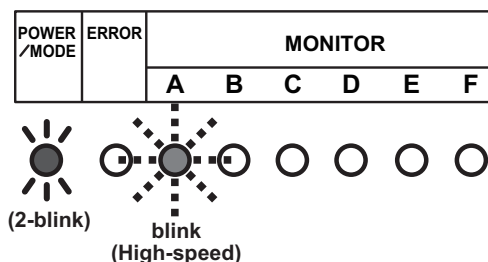

● Wiring/piping number difference

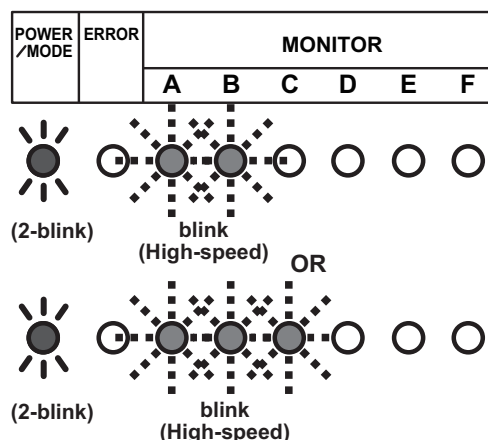

■ Re-display check run results

- If you wish to check the automatic wiring correction contents, by briefly pressing the "CHECK" switch, the check run results is displayed. Check the check run results by referring to the result table in step (4) of "Chapter 14-1-3. ["Operating procedure for check run"](#) on page 330".
- If the automatic wiring correction contents has not been done, the POWER/MODE LED will blink twice and the MONITOR LED will turn off.

■ Automatic wiring correction memory reset

⚠ CAUTION

When relocating the unit, reset the memory beforehand, or the unit may not function normally.

1. Press the "CHECK" switch.
The LED will light as shown in ["Re-display check run results"](#) on page 334".
2. Press the "CHECK" switch for more than 3 seconds when the LED is on.
3. The LEDs from A to F will light in sequence, and then all LEDs will light to indicate the completion of the Automatic wiring correction memory reset.
4. Disconnect the power supply or turn off the breaker.

14-2. Test run

⚠ CAUTION

Always connect the power supply 12 hours prior to the start of the operation in order to protect the compressor.

1. Indoor unit
 - a. Is the drain normal?
 - b. Is there any abnormal noise and vibration during operation?
2. Outdoor unit
 - a. Is there any abnormal noise and vibration during operation?
 - b. Will noise, wind, or drain water from the unit disturb the neighbors?
 - c. Is there any gas leakage?
 - Do not operate the air conditioner in the test running state for a long time.
 - For the operation method of the test run for indoor unit and central remote controller, refer to the operating manual and perform operation check.

■ Test run method

Be sure to temporarily disconnect the power supply or turn off the breaker before changing the DIP switch settings.

1. Check the 3-way valves (both at the liquid side and gas side) are opened. Confirm that the DIP switch SET1-2 is switched off.
2. Set the operation mode to "COOL" or "HEAT". When switching the DIP switch SET1-1 between HEAT and COOL, disconnect the power supply or turn off the circuit breaker beforehand.

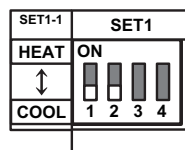

- In the first test run, be sure to set the operation mode to "COOL".
 - The operation mode cannot be switched between "COOL" and "HEAT" during the test run. To switch the operation mode between "COOL" and "HEAT", stop the test run, switch the operation mode, and then start the test run again.
3. Press "TEST RUN" switch for more than 3 seconds.
The POWER / MODE LED flashes once.

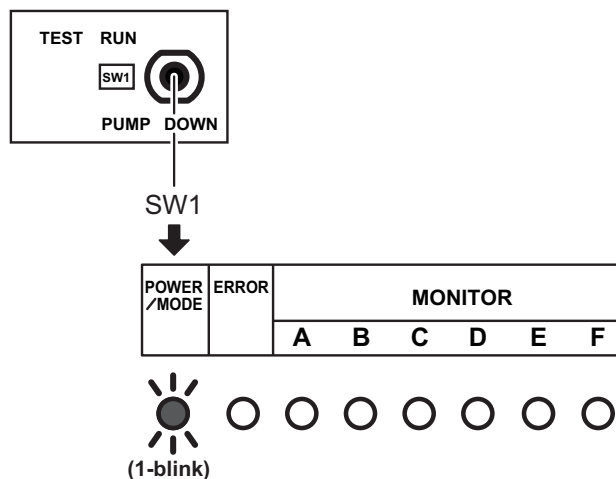

4. Confirm operating status.

5. Press "TEST RUN" switch for more than 3 seconds.

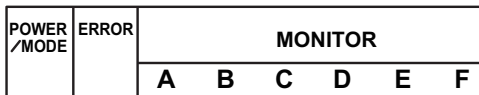

14-3. Error code

If an error occurs, the LED will light up to display the error location and the error code.

■ In the event of an error

The error LED blink quickly.

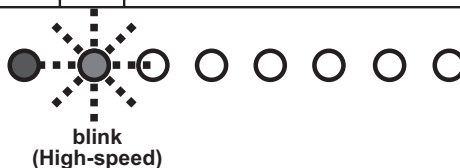
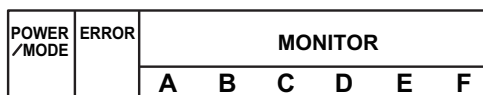

■ Error location display

LEDs A to F of MONITOR light up and display the error location. In the case of an overall error, LEDs A to F of MONITOR do not light up.

Example: Coil error in indoor unit B

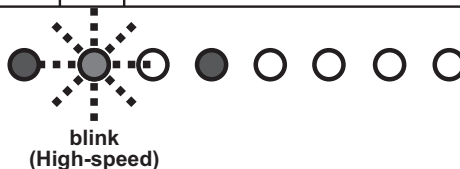
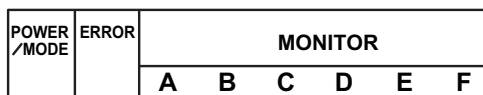

OUTDOOR UNIT
AOYG45LBLA6

OUTDOOR UNIT
AOYG45LBLA6

■ Error code display

While the error is occurring, briefly press SW1. The error code is displayed.

Example: Coil error (Error cord = 9A.1)

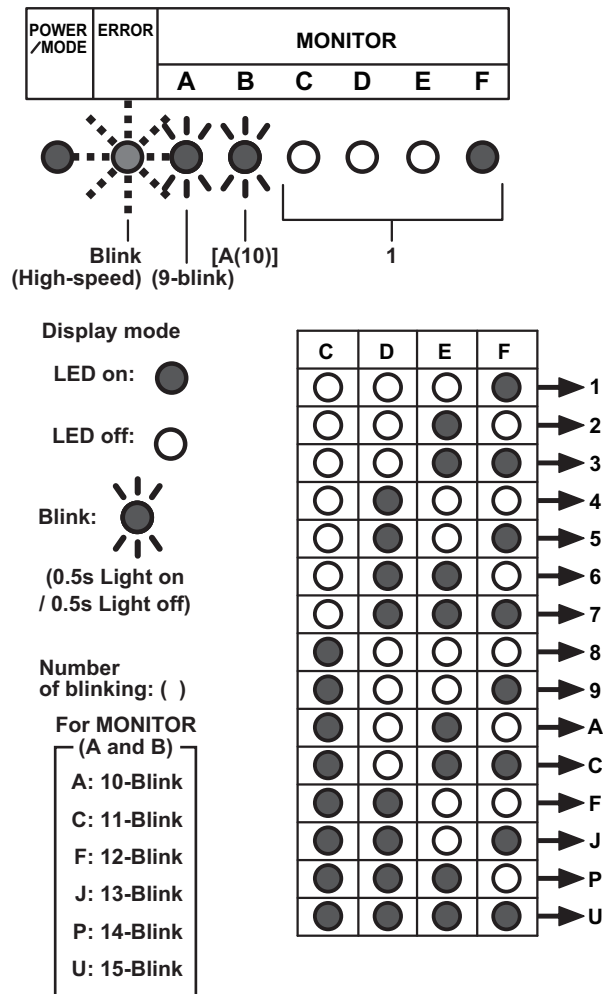

OUTDOOR UNIT
AOYG45LBLA6

OUTDOOR UNIT
AOYG45LBLA6

Error code	Error type
11.3	Serial communication error
11.4	Serial communication error during operation
16.5	Communication error between controller and outdoor unit
22.1	Indoor unit capacity error
5U.1	Indoor unit error
62.1	PCB model information error
62.3	EEPROM access error
62.8	EEPROM data corruption error
63.1	Inverter error
65.3	IPM error (Trip terminal L error)
71.1	Discharge temp. sensor error
72.1	Compressor temp. sensor error
73.2	Heat exchanger middle temp. sensor error
73.3	Heat exchanger liquid temp. sensor error
74.1	Outdoor temp. sensor error
75.1	Suction gas temp. sensor error
76.1	Valve sensor error
76.2	
77.1	Heat sink temp. sensor error
84.1	Current sensor 1 error (stoppage permanently)
86.1	Discharge pressure sensor error
94.1	Trip detection
95.1	Compressor motor control error (stoppage permanently)
97.3	Fan motor 1 error (Duty error)
98.3	Fan motor 2 error (Duty error)
99.1	4-way valve error
9A.1	Coil 1 (expansion valve 1) error
A1.1	Discharge temperature 1 error (stoppage permanently)
A3.1	Compressor 1 temperature error

14-4. Pump down

WARNING

During the pump down operation, make sure that compressor is off before you remove the refrigerant piping. Do not remove the connection pipe while the compressor is in operation with valve open. This may cause abnormal pressure in the refrigeration cycle that leads to breakage and even injury.

■ Pump down operation

When moving or discarding the air conditioner, in order to consider the environment and avoid the discharge of refrigerant to the atmosphere, pump down according to the following procedure.

1. Connect the pressure gauge to the charging port.
2. Change the DIP switch on the board (SET1-2) to On*1
*Be sure the power supply is disconnected on the breaker is turned off when changing the DIP switch.



*1: DIP switch (SET1-2)

3. To start operation, press the [PUMP DOWN] switch*2 for 3 seconds or press after the power has been on for 3 min.

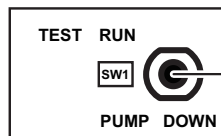

*2: Push switch (SW1)

During pump down, the LED (POWER/MODE) will flash 3 times consecutively.

POWER /MODE	ERROR	MONITOR					
		A	B	C	D	E	F



NOTE: If the [PUMP DOWN] switch is pressed during compressor operation, the compressor will stop, and the operation will start after about 3 min.

4. Close the liquid pipe valve.
5. When the value between 7.3 psi and 0 psi (0.05 Mpa to 0 Mpa) is shown, close the gas pipe valve.
6. Stop pump down by pressing the [PUMP DOWN] switch for 3 seconds.
The LED will light as follows.

POWER /MODE	ERROR	MONITOR					
		A	B	C	D	E	F







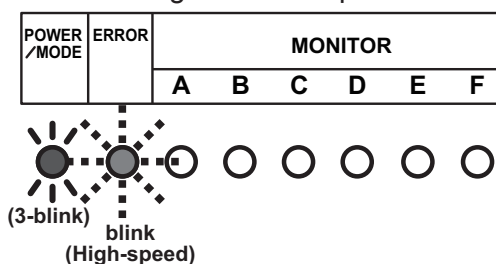



7. Disconnect the power supply or turn off the breaker.

NOTE: If the pump down is not stopped by pressing the switch as in step 6, it will stop automatically after 15 minutes and the LED will light as follows. If the pump down is complete, disconnect the power supply or turn off the breaker. If not completed open the liquid pipe valve, and then start again from step 3.

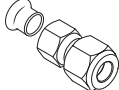

- In order to interrupt the pump down operation, press the [PUMP DOWN] switch again. The LED will return to the original display before starting pump down. (POWER/MODE LED: On)
- The pump down may stop before completion due to error. To complete the pump down, correct the error, open the liquid pipe valve and then start from step 1 again. Otherwise, the refrigerant can be recovered from the service port.

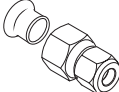
15. Accessories

Part name	Exterior	Q'ty	Part name	Exterior	Q'ty
Installation manual		1	Drain cap		7
Drain pipe		1	Adapter K 12.70 mm (1/2 in) 9.52 mm (3/8 in)		2 set
Cable tie with clip (large)		2	Adapter L 12.70 mm (1/2 in) 15.88 mm (5/8 in)		2 set
Cable tie with clip (small)		2	Adapter H 9.52 mm (3/8 in) 12.70 mm (1/2 in)		1 set
Cable tie		1	Grommet edging		1

16. Optional parts

Exterior	Part name	Model name	Summary
	Central remote controller	UTY-DMMYM	<p>Set temperatures on timers to best meet individuals' needs. Includes a large backlit LCD and 4-way navigation pad.</p> <p>Remote controller cable: 0.33 mm² (22AWG)</p> <p>NOTE: The remote controller cable supplied with this controller is for indoor use. If you require cables for outdoor use, purchase locally. Material is not specified. However, it should be selected considering the installing environment (temperature, humidity), and regional regulations (RoHS Directive, etc.).</p>

17. Outdoor unit installation precautions

NOTE: The information listed below are general precautions.
Some models also include items that do not apply.

17-1. Places where prohibited for use

- Places where there is a danger of combustible gas leakage.
- Places where sulfur gas, chlorine gas, acid, alkali, or other matter which effects equipment is generated.
- Places not affected by heat radiation from other heat sources.
- Places where the air is not stagnant.
- Places where machinery which generates high frequencies is used.
- Ocean beaches and other areas where there is a lot of salt.
- Inside of vehicles, ships, and other conveyances.
- Places where voltage fluctuations are product.

17-2. Points to remember when installing

- The product shall be installed at a place which can withstand the weight and vibration of the outdoor unit.
- To allow maintenance after refrigerant piping, drain piping, and electric wiring connection and installation, provide an installation service space.
*Installation service space is shown in "[Installation space](#)" on page 348.
- Be careful when installing the set at the following places.

Condition	Contents	Countermeasures (Reference)
When installed near adjacent houses.	Perform installation work so that operating sound does not disturb the neighbors.	<ol style="list-style-type: none"> 1. Install a soundproof barrier. 2. Change the installation site.
When there is the possibility of strong wind.	<ul style="list-style-type: none"> • If the outdoor unit is exposed to strong wind, capacity may drop, frost may form during heating, and operation may be stopped by high pressure rise. In addition, when a very strong wind blows, the fan may be damaged. • When a very strong wind blows, there is the possibility of the outdoor unit being toppled over if held only by foundation bolts. 	<ol style="list-style-type: none"> 1. Install the outdoor unit with keeping a sufficient distance between the outlet side of the unit and a facing wall or fence. 2. Make the outlet direction and wind direction perpendicular. 3. Fasten the outdoor unit using toppling prevention hardware (purchased locally).
When snow accumulates.	If the outdoor unit is covered by accumulated snow, it may not be able to operate.	<ol style="list-style-type: none"> 1. Make the foundation as high as possible. 2. Perform snow prevention work.
When installing the inverter type.	It may generate noise in TV sets, stereos and PCs.	The inverter type should be installed at a sufficient distance from these equipments.