

**SPLIT TYPE
ROOM AIR CONDITIONER**
Floor Ceiling type /
Duct type / Cassette type
INVERTER

SERVICE INSTRUCTION

Models	Indoor unit	Outdoor unit
	AU*G24LVLA	AO*G24LBCB
	AB*G24LVTA	
	AR*G24LMLA	



CONTENTS

1. DESCRIPTION OF EACH CONTROL OPERATION

1. COOLING OPERATION.....	01-01
2. HEATING OPERATION.....	01-02
3. DRY OPERATION.....	01-02
4. AUTO CHANGEOVER OPERATION.....	01-03
5. INDOOR FAN CONTROL.....	01-05
6. OUTDOOR FAN CONTROL.....	01-09
7. LOUVER CONTROL.....	01-10
8. COMPRESSOR CONTROL.....	01-13
9. TIMER OPERATION CONTROL.....	01-14
10. ELECTRONIC EXPANSION VALVE CONTROL.....	01-18
11. TEST OPERATION CONTROL.....	01-18
12. PREVENT TO RESTART FOR 3 MINUTES (3 MINUTES ST).....	01-18
13. 4-WAY VALVE EXTENSION SELECT.....	01-18
14. AUTO RESTART.....	01-19
15. MANUAL AUTO OPERATION.....	01-19
16. COMPRESSOR PREHEATING.....	01-19
17. 10°C HEAT OPERATION.....	01-20
18. ECONOMY OPERATION.....	01-20
19. FRESH AIR CONTROL.....	01-20
20. EXTERNAL ELECTRICAL HEATER CONTROL.....	01-20
21. DRAIN PUMP OPERATION.....	01-21
22. DEFROST OPERATION CONTROL.....	01-22
23. OFF DEFROST OPERATION CONTROL.....	01-24
24. VARIOUS PROTECTIONS.....	01-25
25. FORCED COOLING OPERATION.....	01-26
26. COMPRESSOR STOP CONTROL.....	01-26

2. TROUBLE SHOOTING

2-1 ERROR DISPLAY	02-01
2-1-1 INDOOR UNIT & WIRED REMOTE CONTROLLER DISPLAY.....	02-01
2-1-2 WIRED REMOTE CONTROLLER DISPLAY.....	02-02
2-1-3 WIRELESS LAN INDICATOR DISPLAY.....	02-03
2-1-4 MOBILE APP DISPLAY(For AIR CONDITIONER).....	02-04
2-1-5 MOBILE APP DISPLAY(In WIRELESS LAN CONTROL SYSTEM).....	02-05
2-2 TROUBLE SHOOTING WITH ERROR CODE	02-11
2-3 TROUBLE SHOOTING WITH NO ERROR CODE	02-37
2-4 TROUBLE SHOOTING WITH ERROR CODE(For WIRELESS LAN ADAPTER).....	02-42
2-5 SERVICE PARTS INFORMATION	02-50

Refrigerant
R410A

***FLOOR CEILING /SLIM DUCT
MINIDUCT /CASSETTE type
INVERTER***

**1 . DESCRIPTION OF EACH
CONTROL OPERATION**

1-1. COOLING OPERATION

1-1-1 COOLING CAPACITY CONTROL

A sensor (room temperature thermistor) built in the indoor unit will usually perceive difference or variation between a set temperature and present room temperature, and controls the operation frequency of the compressor.

The maximum frequency is limited in the range shown in Figure 1 based on the fan speed mode and the outdoor temperature.

- * If the room temperature is 2 degC higher than a set temperature, the compressor operation frequency will attain to maximum frequency.
- * If the room temperature is 2.5 degC lower than a set temperature, the compressor will be stopped.
- * When the room temperature is between +2 degC to -2.5 degC of the setting temperature, the compressor frequency is controlled within the range shown in Table1.

(Table 1 : Compressor Frequency Range)

minimum frequency	maximum frequency
20rps	100rps

(Fig. 1 : Limit of Maximum Frequency based on Outdoor Temperature)

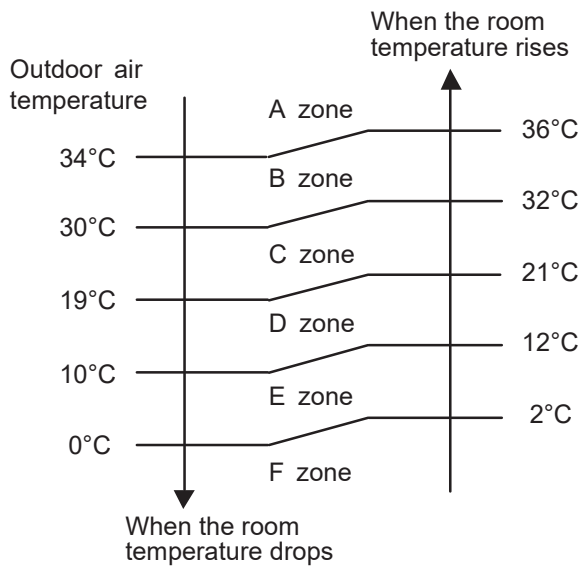

Fan speed mode	Hi	Me	Lo	Quiet
A zone	111rps	74rps	60rps	29rps
B zone	111rps	74rps	60rps	29rps
C zone	80rps	60rps	45rps	29rps
D-F zone	60rps	45rps	34rps	20rps

1.2. HEATING OPERATION

1-2-1 HEATING CAPACITY CONTROL

A sensor (room temperature thermistor) built in the indoor unit will usually perceive difference or variation between a set temperature and present room temperature, and controls the operation frequency of the compressor.

- * If the room temperature is lower 3 degC than a set temperature, the compressor operation frequency will attain to maximum frequency.
- * If the room temperature is higher 2.5 degC than a set temperature, the compressor will be stopped.
- * When the room temperature is between +2.5 degC to -3 degC of the setting temperature, the compressor frequency is controlled within the range shown in Table2.

(Table 2 : Compressor Frequency Range)

minimum frequency	maximum frequency
10 rps	110 rps

1.3. DRY OPERATION

1-3-1 INDOOR UNIT CONTROL

The compressor rotation frequency shall change according to set temperature and room temperature variation which the room temperature sensor of the indoor unit has detected as shown in the Fig 2.

(Table 3 : Compressor frequency)

Operating frequency
29 rps

(Fig.2 : Compressor Control based on Room Temperature)

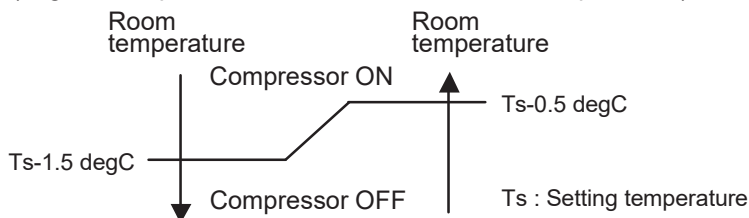

1-4. AUTO CHANGEOVER OPERATION

When the air conditioner is set to the Auto mode by remote controller, operation starts in the optimum mode from among the Heating, Cooling, Dry and Monitoring mode. During operation, the optimum mode is automatically switched in accordance with temperature changes. The temperature can be set between 18°C and 30°C in 1°C steps.

- ① When operation starts, indoor fan and outdoor fan are operated for around 2 minutes (AB type, AR type), or 3 minutes (AU type). Room temperature and outdoor temperature are sensed, and the operation mode is selected in accordance with the table below. **<Monitoring mode>**

(Table 4 : Operation mode selection table)

Room temperature (TR)	Operation mode
$TR > Ts + 2^{\circ}\text{C}$	Cooling (Automatic dry)
$Ts + 2^{\circ}\text{C} \geq TR \geq Ts - 2^{\circ}\text{C}$	*Middle zone
$TR < Ts - 2^{\circ}\text{C}$	Heating

TR : Room temperature
Ts : Setting temperature

*If it's Middle zone, operation mode of indoor unit is selected as below.

- (1). Same operation mode is selected as outdoor unit.
If outdoor unit is operating in Cooling, Dry, and Heating mode, indoor unit will be operated by the same operation mode.
- (2). Selected by the outdoor temperature.
If outdoor unit is operating in other than Cooling, Dry, and Heating mode, indoor unit will be operated according to the outdoor temperature as below.

(Fig. 3 : Outdoor temperature zone selection)

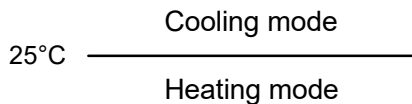

- ② When Cooling or Dry mode was selected at ① and air flow mode is Auto, the air conditioner operates as follow.
- The same operation as COOLING OPERATION AND DRY OPERATION.
 - When the room temperature has remained at set temperature -1.5°C, operation is automatically switched to Dry mode.
 - If the room temperature reaches set temperature +2°C during Dry mode, operation returns to Cooling.

(Fig.4 : Auto changeover : Cooling - Dry)

(Air flow mode : Auto)

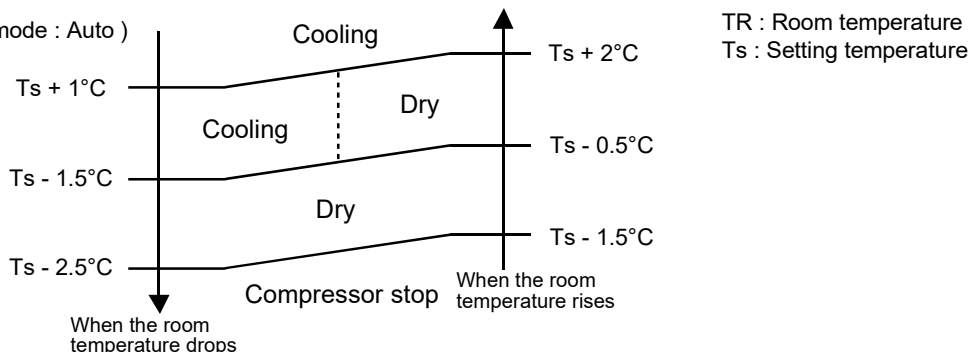

- ③ When Heating was selected at ①, the same operation as HEATING OPERATION of page 01-02 is performed.
- ④ When the compressor was stopped for 6 consecutive minutes by the temperature control function after the Cooling(Auto:Dry) or Heating mode was selected at ① above, operation is switched to Monitoring and the operation mode is selected again.

■ AUTO CHANGEOVER operation flow chart

T_s : Setting temperature

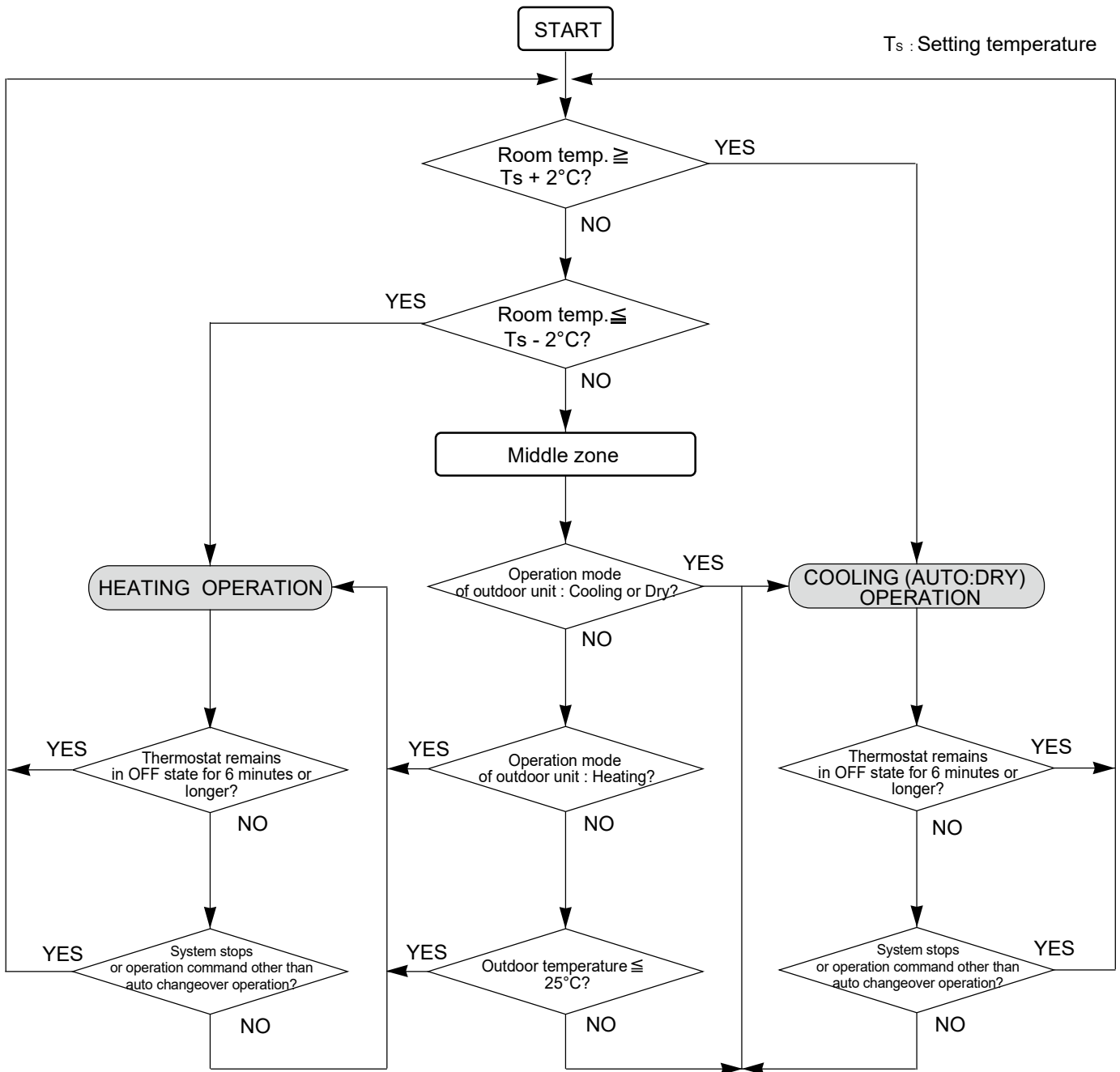

1-5. NDOOR FAN CONTROL

1. Fan speed

(Table 5 : Indoor Fan Speed)

•AR*G24LMLA

Operation mode	Air flow mode	Speed (rpm)
Heating	Hi	830
	Me	700
	Lo	600
	Quiet	550
	S-Lo	350
Cooling Fan	Hi	830
	Me	700
	Lo	600
	Quiet	550
	*Soft Quiet	350
Dry	Auto	550
Monitoring	S-Lo	350

*Note, during Economy operation and operation mode is Fan, air flow is 1 step downs.

(Hi > Me, Me > Lo, Lo > Quiet, Quiet > Soft Quiet)

•AU*G24LVLA

Operation mode	Air flow mode	Speed (rpm)
Heating	Hi	960
	Me+	930
	Me	880
	Lo	740
	Quiet	580
	Cool air prevention	400
Cooling Fan	S-Lo	300
	Hi	960
	Me	850
	Lo	650
	Quiet	500
Dry	*Soft Quiet	400
	Auto	500
Monitoring	S-Lo	300

*Note, during Economy operation and operation mode is Fan, air flow is 1 step downs

(Hi > Me, Me > Lo, Lo > Quiet, Quiet > Soft Quiet)

•AB*G24LVTA

Operation mode	Air flow mode	Speed (rpm)
Heating	Hi	1300
	Me+	1200
	Me	1150
	Lo	1000
	Quiet	780
	Cool air prevention	500
	S-Lo	300
Cooling Fan	Hi	1330
	Me	1150
	Lo	1000
	Quiet	780
	*Soft Quiet	500
Dry	Auto	780
Monitoring	S-Lo	300

*Note, during Economy operation and operation mode is Fan, air flow is 1 step downs

(Hi > Me, Me > Lo, Lo > Quiet, Quiet > Soft Quiet)

2. FAN OPERATION

The airflow can be switched in 5 steps such as AUTO, QUIET, LOW, MED, HIGH, while the indoor fan only runs.

When Fan mode is set at (Auto), it operates on [MED] Fan Speed.

3. COOLING OPERATION (Auto : Cooling)

Switch the airflow [AUTO], and the indoor fan motor will run according to a room temperature, as shown in Figure 5.

On the other hand, if switched in [HIGH] ~ [QUIET], the indoor motor will run at a constant airflow of [COOL] operation modes QUIET, LOW, MED, HIGH, as shown in Table 5.

(Fig.5 : Airflow change - over (Cooling : AUTO))

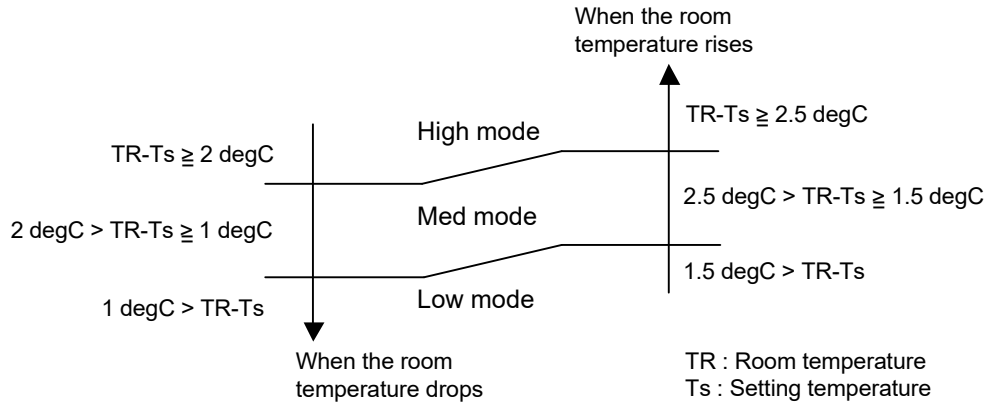

4. DRY OPERATION (Auto : Dry)

Refer to Table 6. During the dry mode operation, the fan speed setting can not be changed.

5. INDOOR UNIT FAN CONTROL FOR ENERGY SAVING (Cooling mode)

Switch the airflow at cooling mode, and the indoor fan motor will run as shown in Fig.6. It depends on the Function setting "Indoor unit fan control for energy saving."

(Fig.6 : Indoor Fan Control)

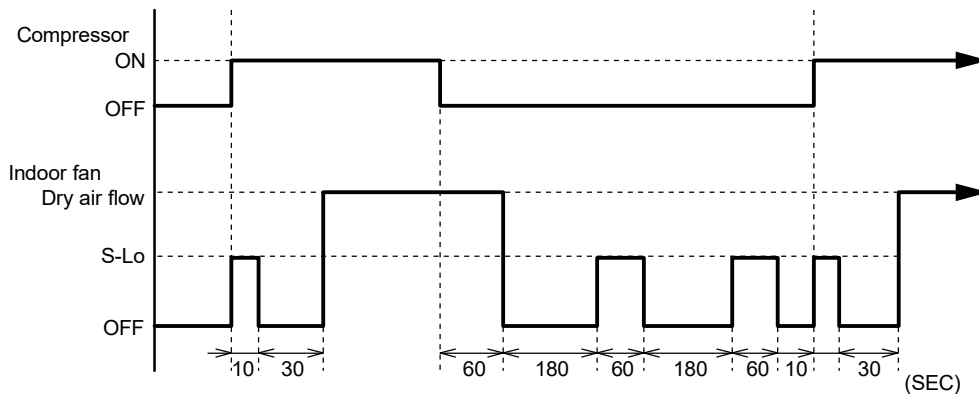

6. HEATING OPERATION (Auto : Heating)

Switch the airflow [AUTO], and the indoor fan motor will run according to a room temperature, as shown in Figure 7.

On the other hand, if switched [HIGH] ~ [QUIET], the indoor motor will run at a constant airflow of [HEAT] operation modes QUIET, LOW, MED, HIGH, as shown in Table 5.

(Fig.7 : Airflow change - over (Heating : AUTO))

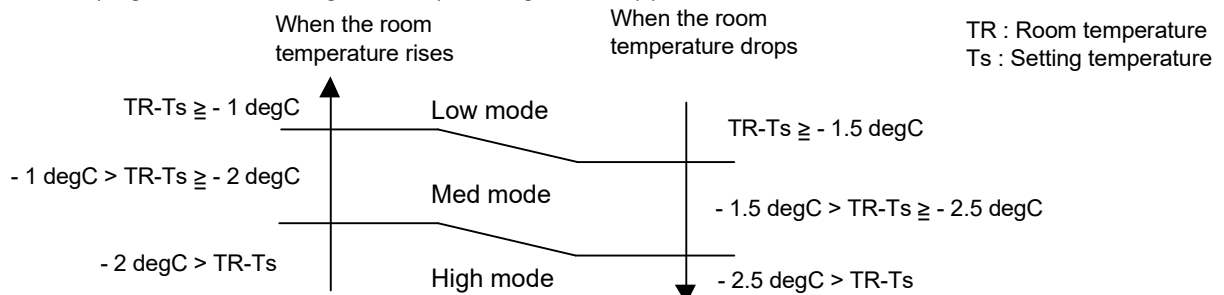

7. COOL AIR PREVENTION CONTROL (Heating mode)

The maximum value of the indoor fan speed is set as shown in Figure 8, based on the detected temperature by the indoor heat exchanger sensor on heating mode.

When the compressor does not operate, the indoor fan motor operates [S-Lo] mode.

(Fig.8 : Cool Air Prevention Control)

7-1. For AB*G24LVTA

During Normal Heating operation

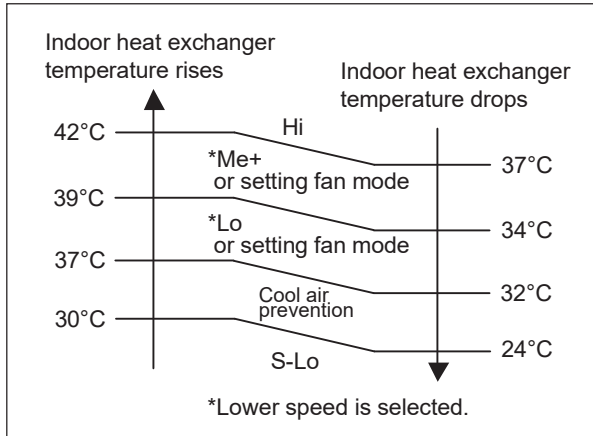

During 10°C Heat operation

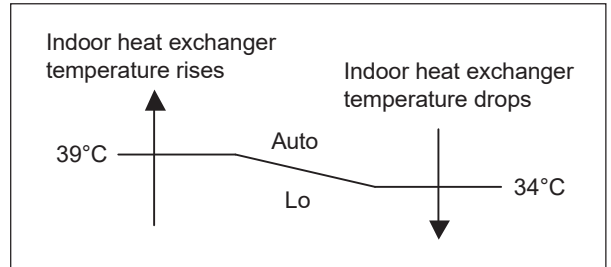

7-2. For AU*G24LVLA

During Normal Heating operation

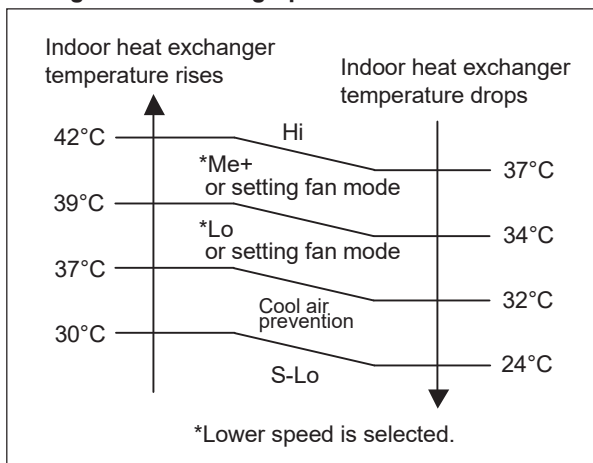

During 10°C Heat operation

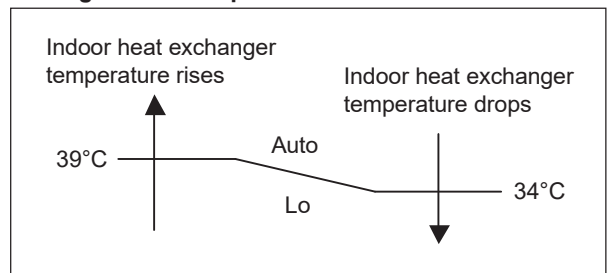

7-3. For AR*G24LMLA

During Normal Heating operation

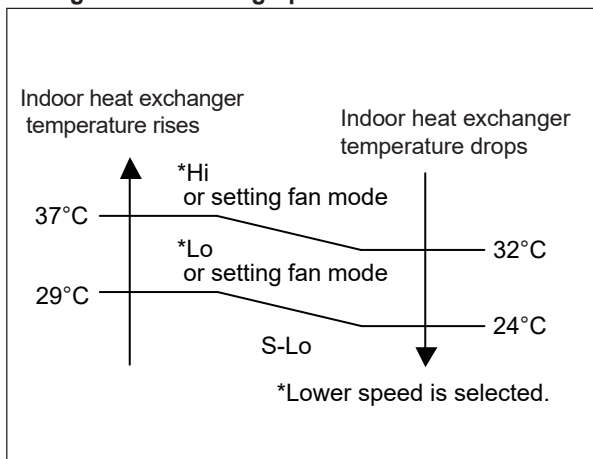

During 10°C Heat operation

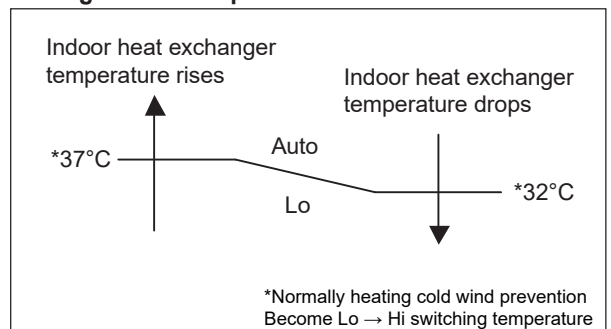

1-6. OUTDOOR FAN CONTROL

1. Outdoor Fan Motor

Following table shows the fan speed of the outdoor unit.

(Table 6 : Fan speed of the outdoor unit)

	Cooling / Dry				Heating
	Y zone	Z zone	F zone	G zone	
S-Hi2	-	-	-	-	1100
S-Hi1	1000	-	-	-	1100
Hi	1000	-	-	-	1100
10	-	-	-	-	1100
9	1000	770	320	220	940
8	940	630	320	220	850
7	770	470	220	190	700
6	630	270	220	190	550
5	550	270	220	190	470
4	550	270	220	190	440
3	510	270	220	190	440
2	510	270	220	190	440
1	510	270	220	190	440

Ambient Temperature zone

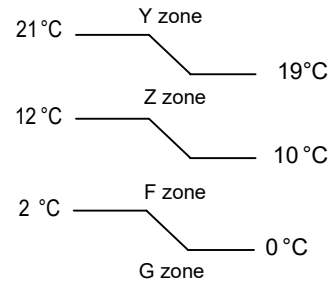

- The outdoor fan speed is changed in the range of the speed shown in the above table, based on the frequency of the compressor.
(When the compressor frequency increases, the outdoor fan speed is also changed to higher speed. If the compressor frequency decreases, the outdoor fan speed is changed to the lower speed as well.)
After starting up the outdoor fan, it operates with the following speed for initial 20 seconds.

(Table 7 : Fan speed when starting up outdoor fan)

Outdoor temperature	Fan speed
Over than 12°C	500 rpm
Less than 12°C	190 rpm

- After operating the defrost control on heating mode, the fan speed becomes 190rpm when the outdoor temperature is below 1 °C until the HEX(outlet) temper reaches 0 °C. However, it returns to the normal speed control when the defrosting operation does not function for 240 minutes after releasing the defrost operation or when the outdoor temperature sensor detection value becomes higher than 2°C.

1-7. LOUVER CONTROL

1. For Ceiling Type <AB*G24LVTA >

1-1. VERTICAL LOUVER CONTROL

(Function Range)

Each time the button is pressed, the air direction range will change as follows:

①→②→③→④→⑤→⑥→⑦

(Operation Range)

During Cooling/Dry mode : ①—②—③—④

During Heating mode : ⑤—⑥—⑦

Fan mode : ①—②—③—④—⑤—⑥—⑦

Use the air direction adjustments within the ranges shown above.

(Fig.9 : Air Direction Range)

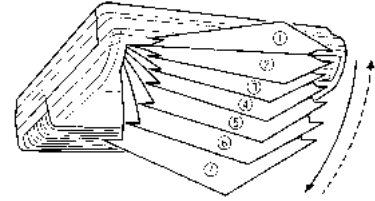

- The vertical airflow direction is set automatically as shown, in accordance with the type of operation selected.

Cooling / Dry / Fan mode : Horizontal flow ①

Heating mode : Downward flow ⑦

- During AUTO mode operation, for the first minute after beginning operation, air-flow will be horizontal ①; the air direction cannot be adjusted during this period.

1-2. SWNG OPERATION

When the swing signal is received from the remote controller, the vertical louver starts to swing. The range of swing depends on the set airflow direction.

The type of operation	Range of swing
Cooling/Dry	① to ④
Heating	③ to ⑦
FAN(① to ④)	① to ④
FAN(⑤ to ⑦)	③ to ⑦

- When the indoor fan is either at S-Lo or Stop mode, the swinging operation is interrupted and the louver stops at the memorized position.
(Stop mode means Operation stop.)

1-3. HORIZONTAL LOUVER CONTROL

(Function Range)

Each time the button is pressed, the air direction range will change as follows:

①↔②↔③↔④↔⑤

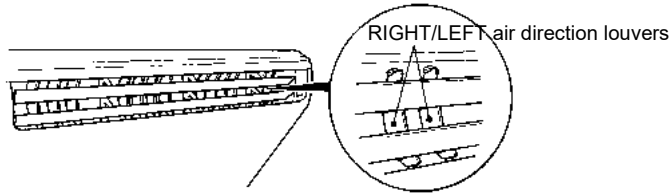

(Fig.10 : Air Direction Range)

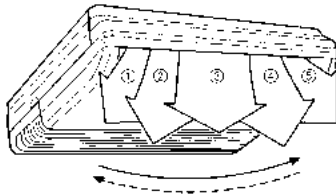

Use the air direction adjustments within the ranges shown above.
The remote control unit's display does not change.

1-4. SWING OPERATION

When the swing signal is received from the remote controller, the horizontal louver starts to swing.
The range of swing depends on the set airflow direction.

The type of operation	Range of swing
Cooling/Dry	① to ⑤ (All range)
Heating	① to ⑤ (All range)
FAN	① to ⑤ (All range)

- When the indoor fan is either at S-Lo or Stop mode, the swinging operation is interrupted and the louver stops at the memorized position.
(Stop mode means Operation stop.)

2. For Cassette Type < AU*G24LVLA >

2-1. VERTICAL LOUVER CONTROL

(Function Range)

Each time the button is pressed, the air direction range will change as follows:

① ↔ ② ↔ ③ ↔ ④

(Operation Range)

During Cooling/Dry mode/Fan mode : ①—②—③—④

During Heating mode : ①—②—③—④

Use the air direction adjustments within the ranges shown above.

(Fig.11 : Air Direction Range)

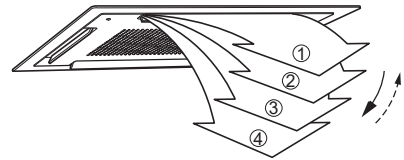

- The vertical airflow direction is set automatically as shown, in accordance with the type of operation selected.

Cooling / Dry / Fan mode : Horizontal flow ①

Heating mode : Downward flow ④

- During AUTO mode operation, for the first minute after beginning operation, air-flow will be horizontal ①; the air direction cannot be adjusted during this period.

2-2. SWNG OPERATION

When the swing signal is received from the remote controller, the vertical louver starts to swing. The range of swing depends on the set airflow direction.

The type of operation	Range of swing
Cooling/Dry/Fan	① to ④
Heating	① to ④

- When the indoor fan is either at S-Lo or Stop mode, the swinging operation is interrupted and the louver stops at the memorized position.
(Stop mode means Operation stop.)

1-8. COMPRESSOR CONTROL

1. OPERATION FREQUENCY RANGE

The operation frequency of the compressor is different based on the operation mode as shown in Table 8.

(Table 8 : Compressor Operation Frequency Range)

Cooling / Dry		Heating	
Min	Max	Min	Max
20rps	100rps	10rps	110rps

2. OPERATION FREQUENCY CONTROL AT START UP

The allowable maximum compressor frequency after the start up is shown in Figure 12.

(Fig.12 : Compressor Control at Start-up)

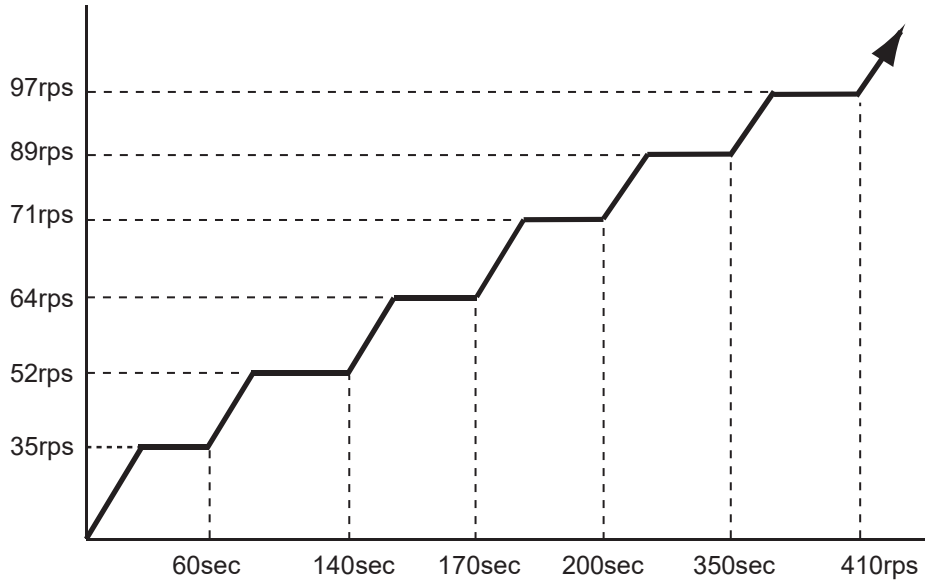

1-9. TIMER OPERATION CONTROL

1-9-1 Wired Remote Controller

AR-WAE1E

- ON / TIMER
- OFF / TIMER
- WEEKLY TIMER
- TEMPERATURE SET BACK TIMER

1. ON /OFF TIMER

- OFF timer : When the clock reaches the set time, the air conditioner will be turned off.

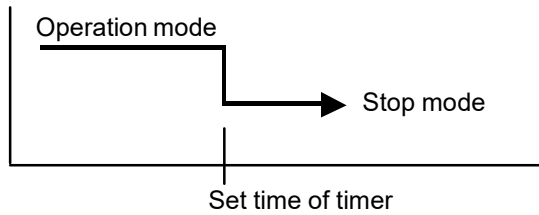

- ON timer : When the clock reaches the set time, the air conditioner will be turned on.

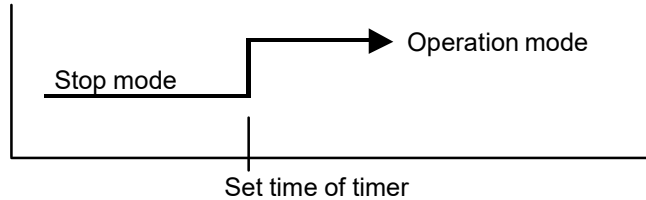

2. WEEKLY TIMER

2-1. WEEKLY TIMER

- Use this timer function to set operating time for each day of the week.
- The weekly timer allows up to two ON and OFF time to set up per day.

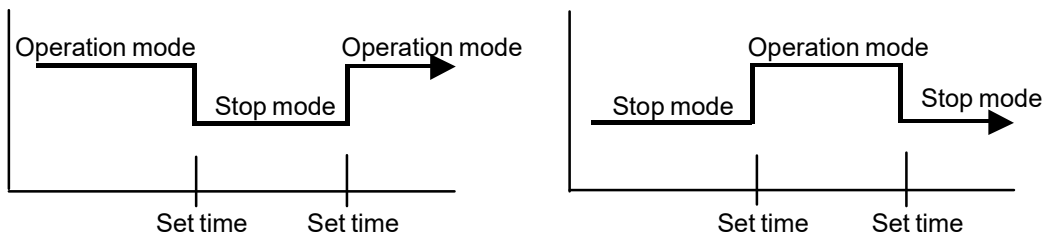

- The operating time can be set in 30 min increments only.
- The OFF time can be carried over to next day.
- The ON timer and the OFF timer functions cannot be set with using the weekly timer. Both ON and OFF time must be set.

2-2. DAY OFF setting

- The DAY OFF setting is only available for days for which weekly settings already exist.
- If the operating time carries over to the next day (during a next day setting), the effective DAY OFF range will be set as shown below.

• Normal

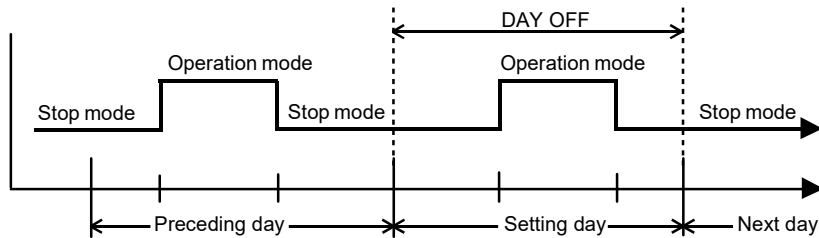

• Next day setting

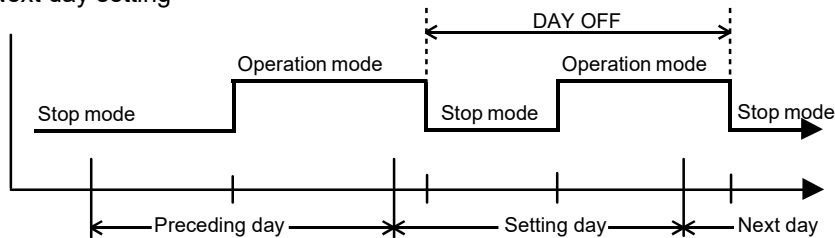

- The DAY OFF setting can only be set one time. The DAY OFF setting is cancelled automatically after the set day has passed.

3. TEMPERATURE SET BACK TIMER

- The SET BACK timer only changes the set temperature for 7 days, it cannot be used to start or stop air conditioner operation.
- The SET BACK timer can be set to operate up to two times per day but only one temperature setting can be used.
- During the COOL/DRY mode, the air conditioner will operate at a minimum of 18°C even if the SET BACK temperature is set to 17°C or lower.

Case of SET BACK timer on the Cooling operation.

(Setting temperature :22°C, SET BACK temperature :26°C)

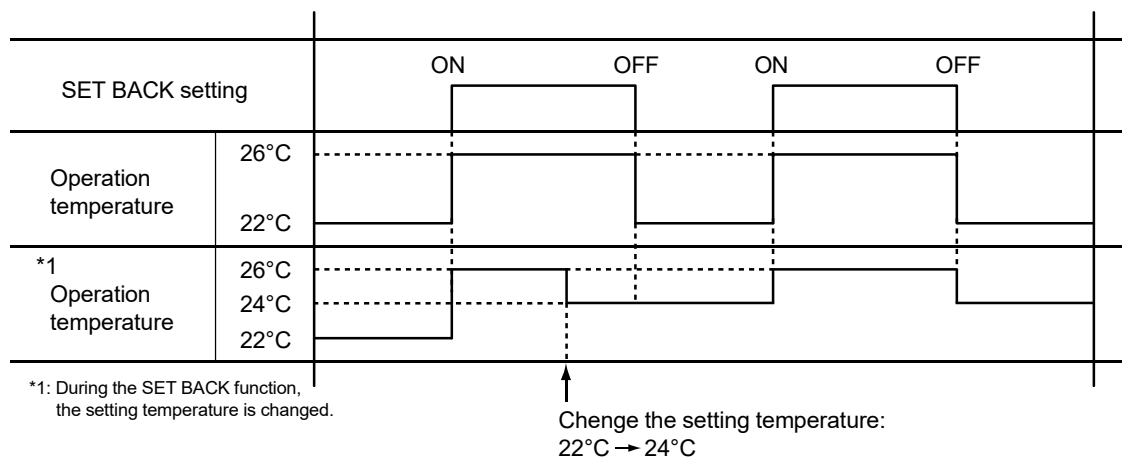

3. SLEEP TIMER

- If the sleep timer is set, the room temperature is monitored and the operation is stopped automatically. If the operation mode or the set temperature is change after the sleep timer is set, the operation is continued according to the changed setting of the sleep timer from that time ON.

In the cooling operation mode

When the sleep timer is set, the setting temperature is increased 1 degC. It increases the setting temperature another 1 degC after 1 hour. After that, the setting temperature is not changed and the operation is stopped at the time of timer setting.

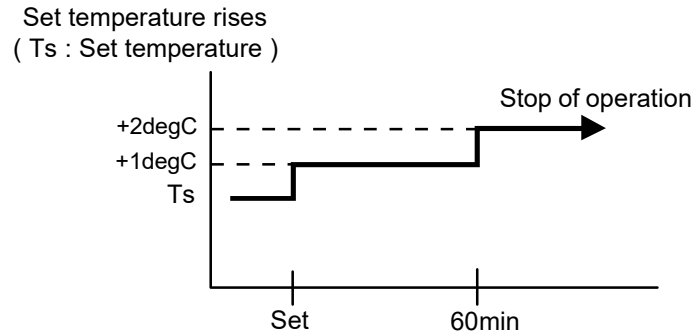

In the heating operation mode

When the sleep timer is set, the setting temperature is decreased 1 degC. It decreases the setting temperature another 1 degC every 30 minutes. Upon lowering 4 degC, the setting temperature is not changed and the operation stops at the time of timer setting.

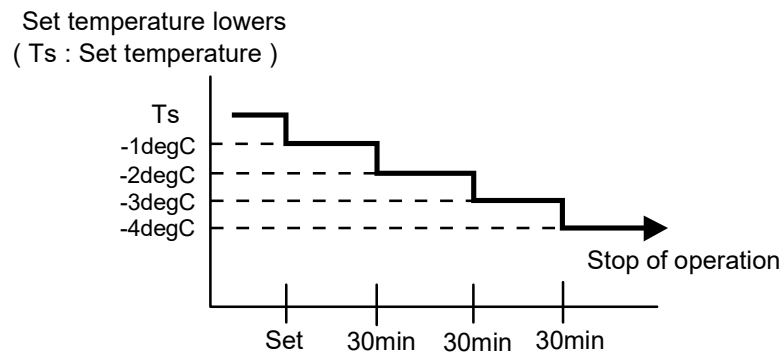

1-10. ELECTRONIC EXPANSION VALVE CONTROL

The most proper opening of the electronic expansion valve is calculated and controlled under the present operating condition based on the following values.
The compressor frequency, the temperatures detected by the discharge temperature sensor, the indoor heat exchanger sensor, the outdoor heat exchanger sensor, and the outdoor temperature sensor.

(1) Pulse range of EEV

Operation	Pulse range
Cooling/ Dry	52 ~ 480 pulse
Heating	

(2) The EEV is set up at 480 pulses when the compressor is stopped.

(3) Initialization (Input of 528 pulses toward closing direction) is operated under the following condition.

* When the power is turned on.

* 4 hours has passed since the last initialization, and 3 minutes has passed after the compressor stop. (If 12 hours has passed since the last initialization, the compressor is compulsorily stopped.)

1-11. TEST OPERATION CONTROL

▪ With Wired Remote Controller (3-wire)

Under the condition where the air conditioner stops, press the MODE button and the FAN button simultaneously for 2 seconds or more, and the test operation control mode will appear.

During test running, "a!" will display on the remote controller display.

Set the test operation mode, and the compressor will continue to run regardless of whatever the room temperature sensor detects.

The test operation mode is released if 60 minutes have passed after setting up the test operation.

▪ With Wireless Remote Controller

Under the condition where the air conditioner runs, press the TEST RUN button, and the test operation control mode will appear.

During test running, the operation lamp and timer lamp of the air conditioner body twinkle simultaneously.

Set the test operation mode, and the compressor will continue to run regardless of whether the room temperature sensor detects.

The test operation mode is released if 60 minutes have passed after setting up the test operation.

▪ With Wired Remote Controller (2-wire)

With "Monitor Mode Screen" displayed, press and hold the [MENU] button, [<] button and [ENTER] button simultaneously for at least 2 seconds.

Setting item selection screen is displayed.

Select the number "09" of the item to be set with the [<] or [>] button, press the [ENTER] button to switch to the Setting Screen.

The test operation screen is displayed.

Press the [ENTER] button to test operation begins.

Test operation is completed after about an hour.

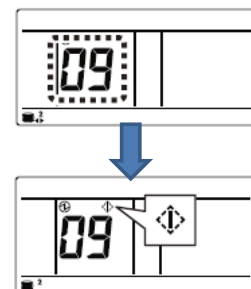

1-12. PREVENT TO RESTART FOR 3 MINUTES (3 MINUTES ST)

The compressor won't enter operation status for 3 minutes after the compressor is stopped, even if any operation is given.

1-13. 4-WAY VALVE EXTENSION SELECT

At the time when the air conditioner is switched from the cooling mode to heating mode, the compressor is stopped, and the 4-way valve is switched in 3 minutes later after the compressor stopped.

1-14. AUTO RESTART

When the power was interrupted by a power failure, etc. during operation, the operation contents at that time are memorized and when power is recovered, operation is automatically resumed with the memorized operation contents.

(Table 9 : Operation contents memorized when the power is interrupted)

	Wireless remote controller	Wired remote controller (Memory Backup : Disable)	Wired remote controller (Memory Backup : Enable)	
Operation mode Set temperature Set air flow Set air flow direction Swing Economy operation 10°C Heat operation	○	○	○	
Thermistor detected position	—	×	○	
Timer mode	○	×	OFF Timer	×
			ON Timer	×
			WEEKLY Timer	○
			Temperature SET BACK Timer	○

○ : Memorize
× : Not memorize

*It is necessary to set on the DIP-SW1-No,6 of the wired remote controller, to enable the memory backup. Refer to the installation manual of wired remote controller for details.

1-15. MANUAL AUTO OPERATION (When using the Wireless RC)

If MANUAL AUTO Button is set, the operation is controlled as shown in Table 10.

If the remote control is lost or battery power dissipated, this function will work without the remote control.

(Table 10)

Operation mode	Auto changeover
Setting temp.	24°C
Fan control mode	Auto
Timer mode	Continuous (No timer setting available)
Vertical louver	Normal
Horizontal louver	Normal
Swing	OFF
Economy	OFF

1-16. COMPRESSOR PREHEATING

When the outdoor heat exchanger temperature is lower than - 4°C (5°C:JM2 Open) and the all operation has been stopped for 30 minutes, power is applied to the compressor and the compressor is heated.

(By heating the compressor, warm air is quickly discharged when operation is started.)

When operation was started, and when the heat exchanger temperature rises up, preheating is ended.

1-17. 10°C HEAT OPERATION

10°C HEAT operation performs as below when pressing 10°C HEAT button.

(Table 11)

Operation mode	Heating
Setting temp.	10°C
Fan control mode	Auto
LED display	Economy
Defrost operation	Operate as normal

1-18. ECONOMY OPERATION

The ECONOMY operation functions by pressing ECONOMY button on the remote controller. At the maximum output, ECONOMY Operation is approximately 70% of normal air conditioner operation for cooling and heating.

The ECONOMY operation is almost the same operation as below settings.

(Table 12)

Mode	Cooling/ Dry	Heating
Target temperature	Setting temp.+1°C	Setting temp.-1°C

1-19. FRESH AIR CONTROL (For AU /AR type)

The fan motor for Fresh Air is operated in synchronization with the indoor fan operation as shown in Figure 13.

(Fig.13 : Fresh air control)

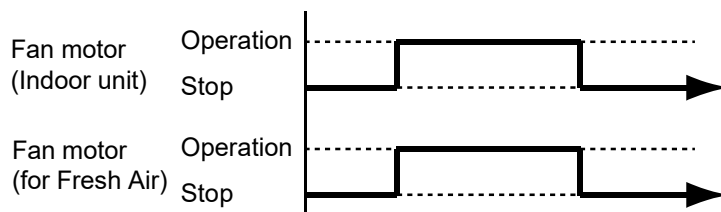

1-20. EXTERNAL ELECTRICAL HEATER CONTROL (For AR type)

The external electrical heater is operated as shown in Figure 14.

(Fig.14 : External electrical heater control)

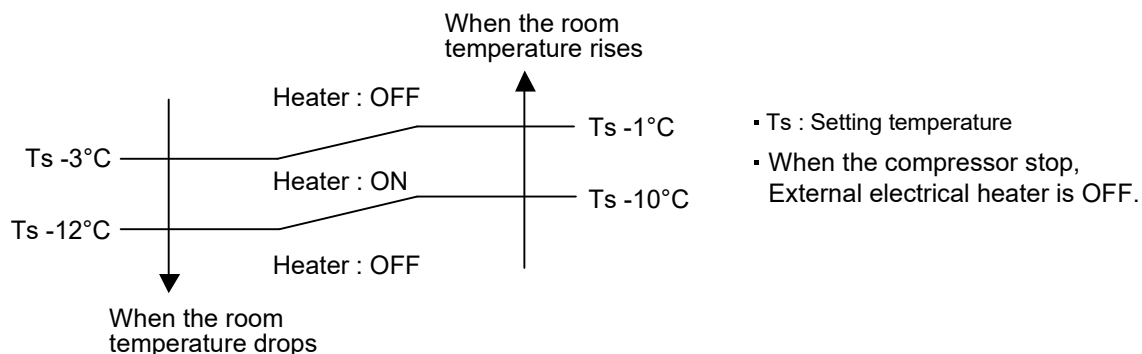

1-21. DRAIN PUMP OPERATION (For AU /AR type)

During Cooling / Dry mode

1. When the compressor starts, the drain pump starts simultaneously.
2. The drain pump operates continuously for 3 minutes after the compressor is turned off.
3. When the compressor stops by the "Anti-freezing protection", the drain pump is turned off in 1 hour after the compressor stops.
4. When the water level in the drain pan rises up and then the float switch functions:
 - ① The compressor, indoor and outdoor fan motor operation are stopped.
 - ② Drain pump operates continuously for 3 minutes after the float switch is turned off. (Almost condensing water may be drained)
 - ③ The indoor unit fan motor operates after the float switch is turned off.
5. When the float switch turns ON continuously for 3 minutes, "FAILURE INDICATION" operates. (It is necessary to turn off power for release it.)
6. When the float switch turns OFF less than 3 minutes, the unit starts Cooling operation.

(Fig. 15 : Detail of Drain Pump Operation in Cooling / Dry)

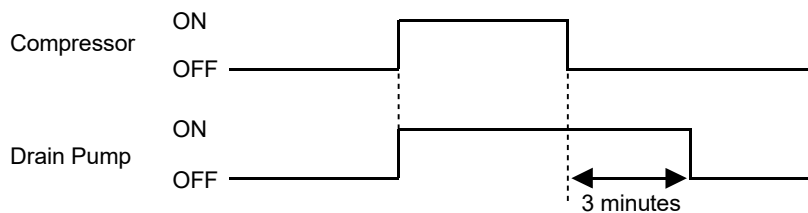

<Float Switch turns OFF less than 3 minutes>

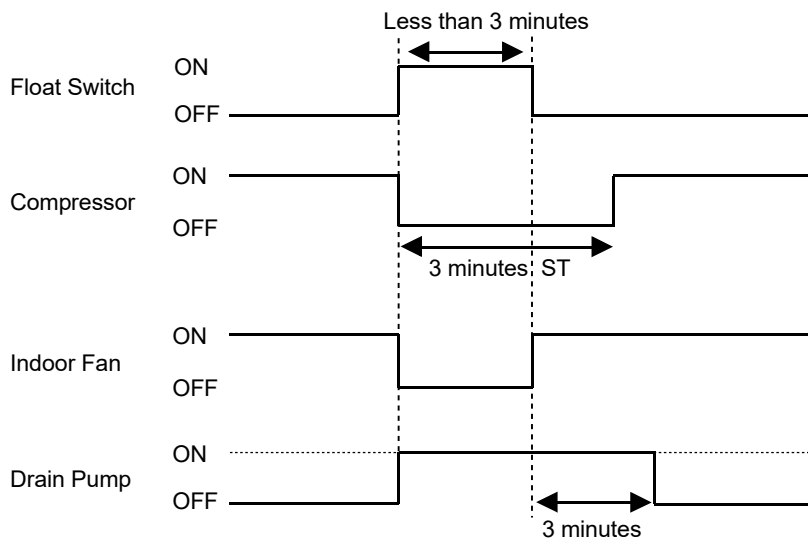

During HEATING / FAN mode / Stop operation

1. When the water level in the drain pan rises up and then the float switch functions:
 - ① Drain pump operates continuously for 3 minutes after the float switch is turned off. (Almost condensing water may be drained)
2. When the float switch turns ON continuously for 3 minutes, "FAILURE INDICATION" operates. Thereafter, even if the float switch turns OFF, the "FAILURE INDICATION" is not released. (It is necessary to turn off power for release it.)

(Fig. 16 : Detail of Drain Pump Operation in Heating)

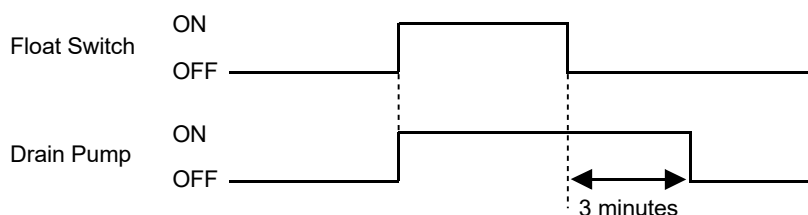

1-22. DEFROST OPERATION CONTROL

1. CONDITION OF STARTING THE DEFROST OPERATION

The defrost operation starts when the outdoor heat exchanger temperature sensor (Tn) detects the temperature lower than the values shown in Table11.

(Table 11 : Condition of starting Defrost Operation)

1 ST time defrosting after starting operation	Compressor integrating operation time		
	Less than 22 min.	22 to 62 min.	More than 62 min.
	Does not operate	- 9°C	- 5°C

Defrosting after 2 ND time upon starting operation	Compressor integrating operation time	
	Less than 40 min.	More than 40min.
	Does not operate	Tn-Tn10 < - 5deg Tn-Tnb < - 2deg However, Tn ≤ - 6°C

Tn10 : Temperature of continuous operation at 10minutes.

Tnb : Back 5minutes temperature

Integrating defrost (Constant monitoring)	Compressor integrating operation time	
	More than 240 min. (For long continuous operation)	Less than 10min.*1 (For intermittent operation)
	- 3°C	OFF count of the compressor 40 times.

*1 : If the compressor continuous operation time is less than 10 minutes,
the OFF number of the compressor is counted.

If any defrost operated, the compressor OFF count is cleared.

2. CONDITION OF THE DEFROST OPERATION COMPLETION

Defrost operation is released when the conditions become as shown in Table12.

(Table12 : Defrost Release Condition)

Release Condition
Outdoor heat exchanger temperature sensor value is higher than +13°C or Compressor operation time has passed 15 minutes.

3. Defrost Flow Chart

The defrosting shall proceed by the integrating operation time, outdoor temperature and outdoor heat exchanger temperature as follows.

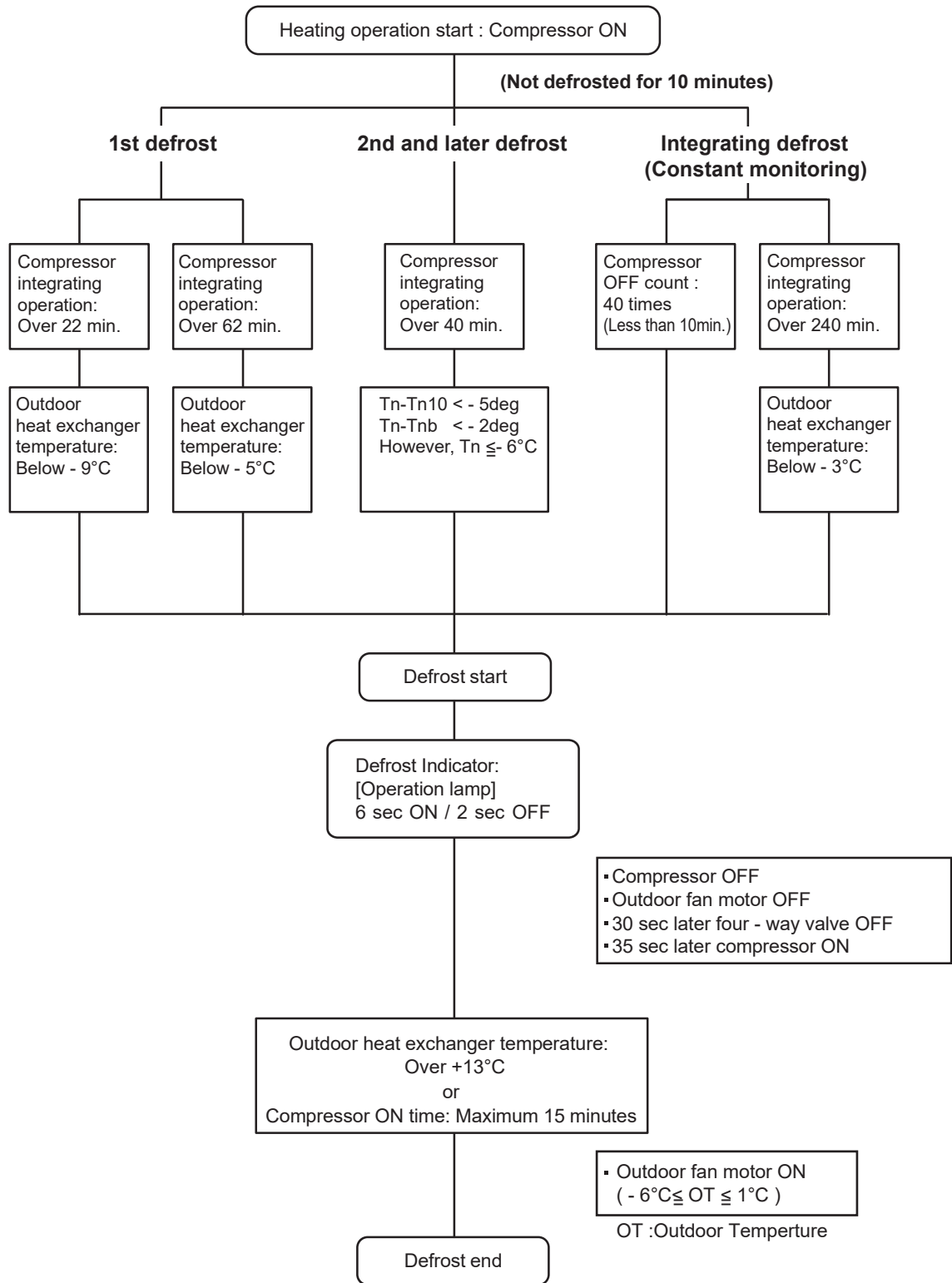

1-23. OFF DEFROST OPEARTON CONTROL

When operation stops in the [Heating operation] mode, if frost is adhered to the outdoor unit heat exchanger, the defrost operation will proceed automatically. In this time, if indoor unit operation lamp flashes slowly, the outdoor unit will allow the heat exchanger to defrost, and then stop.

1. OFF DEFROST OPERATION CONDITION

In heating operation, the outdoor heat exchanger temperature is less than -4°C , compressor continuous operation more than 10 minutes, and compressor operation integrating time lasts for more than 30 minutes.

2. OFF DEFROST END CONDITION

Release Condition
Outdoor heat exchanger temperature sensor value is higher than $+13^{\circ}\text{C}$ or Compressor operation time has passed 15 minutes.

OFF Defrost Flow Chart

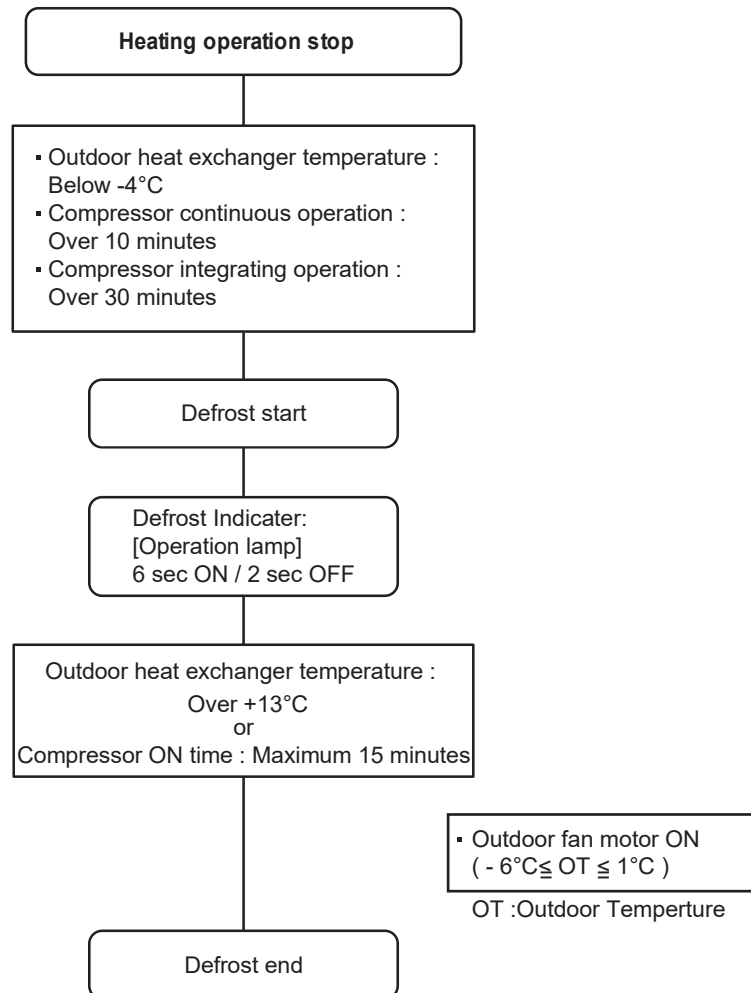

1-24. VARIOUS PROTECTIONS

1. DISCHARGE GAS TEMPERATURE OVERRISE PREVENTION CONTROL

The discharge gas thermosensor (discharge thermistor : Outdoor side) will detect discharge gas temperature.

When the discharge temperature becomes higher than Temperature I ,the compressor frequency is decreased 20rps, and it continues to decrease the frequency for 20rps every 120 seconds until the temperature becomes lower than Temperature I .

When the discharge temperature becomes lower than Temperature II, the control of the compressor frequency is released.

When the discharge temperature becomes higher than Temperature III,the compressor is stopped and the indoor unit LED starts blinking.

(Table14 : Discharge Temperature Over Rise Prevention Control / Release Temperature)

Temperature I	Temperature II	Temperature III
104°C	101°C	110°C

2. CURRENT RELEASE CONTROL

The compressor frequency is controlled so that the outdoor unit input current does not exceeds the current limit value that was set up with the outdoor temperature.

The compressor frequency returns to the designated frequency of the indoor unit at the time when the frequency becomes lower than the release value.

(Table 15 : Current release operation value / release value)

Model 24

[Heating]

OT (Control / Release)	
17°C	10.5A / 10.0A
12°C	10.5A / 10.0A
5 °C	13.5A / 13.0A
	14.5A / 14.0A

OT : Outdoor Temperature

[Cooling]

OT (Control / Release)	
50°C	7.0A / 6.5A
46°C	7.0A / 6.5A
40°C	9.5A / 9.0A
	13.5A / 13.0A

OT : Outdoor Temperature

3. ANTFREEZNG CONTROL (Cooling and Dry mode)

The compressor frequency is decrease on cooling & dry mode when the indoor heat exchanger temperature sensor detects the temperature lower than Temperature I .

Then, the anti-freezing control is released when it becomes higher than Temperature II .

(Table 16 : Anti-freezing Protection Operation / Release Temperature)

Outdoor temperature	Temperature I	Temperature II
Over than 10°C *1 or 12°C *2	4°C	7°C
Less than 10°C *1 or 12°C *2		13°C

*1. When the temperature rises.

*2. When the temperature drops.

4. COOLNG PRESSURE OVERRSE PROTECTON

When the outdoor unit heat exchange sensor temperature rises to 65°C or greater, the compressor is stopped and trouble display is performed.

5. HIGH TEMPERATURE RELEASE CONTROL (HEATNG MODE)

On heating mode, the compressor frequency is controlled as following based on the detection value of the indoor heat exchanger temperature sensor.

(Fig.18 : Heating Overload Protection Control)

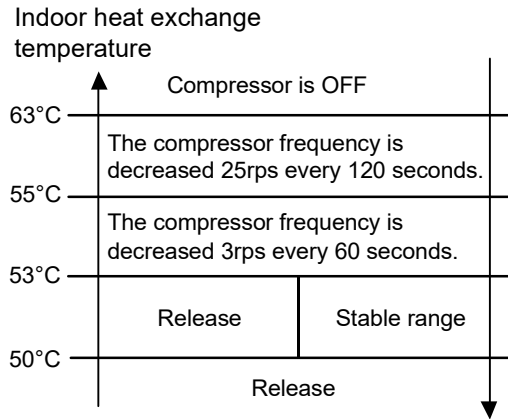

1-25. FORCED COOLNG OPERATON

The forced cooling operation starts up when MANUAL / AUTO button is pressed more than 10 seconds. During the forced cooling operation, it keeps operation regardless of detection value of room temperature sensor. Operation LED and Timer LED light up while the unit is on the forced cooling operation. The forced cooling operation is released after 60 minutes from starting time.

1-26. COMPRESSOR STOP CONTROL

When the detection value of outdoor temperature sensor is lower than temperature I in the table below, the compressor is stopped.

(Table 17 : Operation temperature of compressor stop control)

	Temperature I	
	Cooling	Heating
Operation temperature	- 20°C	—

DUCT type INVERTER

2 . TROUBLE SHOOTING

2 ERROR DISPLAY

2-1 WIRED REMOTE CONTROLLER DISPLAY

1. Check the error

1. If an error occurs, an error icon appears on the "Monitor mode screen".
Touch the [Status] on the "Monitor mode screen". The "Status" screen is displayed.
2. Touch the [Error Information] on the "Status" screen. The "Error Information" screen is displayed.
(If there are no errors, the [Error Information] will not be displayed.)
3. 2-digit numbers correspond to the error code in the table below. Touch the [Next page] (or [Previous page]) to switch to other connected indoor units.

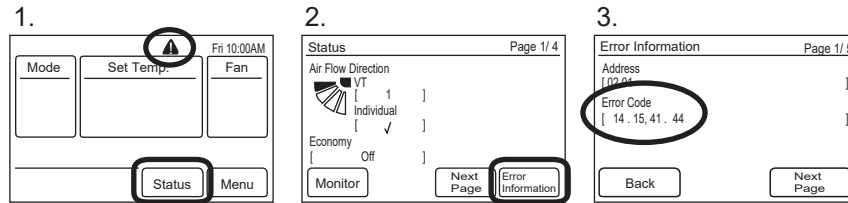

For the details of the indoor unit or outdoor unit error, refer to the error codes in each installation manual

Error Contents	Error Code	Trouble shooting
Serial Communication Error	11	1,2
Wired Remote Controller Communication Error	12	3
Automatic Air flow Adjustment Error	15	4
External communication Error	18	5
Combination Error	23	6
Indoor unit address setting Error	26	7
Connection unit number Error (Indoor unit Wired remote controller Error)	29	8
Indoor unit PCB model information Error	32	9
Indoor unit motor electricity consumption detection Error	33	10
Indoor unit power supply Error for fan motor	39	11
Indoor unit Communication circuit (wired remote controller) Error	3A	12
Indoor Room Thermistor Error	41	13
Indoor Heat Ex. Thermistor Error	42	14
Indoor Unit Fan Motor Error	51	15
Drain pump Error	53	16
Outdoor unit main PCB model information error	62	17
Inverter Error	63	18

Error Contents	Error Code	Trouble shooting
PFC circuit Error	64	19
Trip terminal L Error	65	20
Discharge Thermistor Error	71	21
Heat Ex. (Middle/Outlet) Temp. Thermistor Error	73	22
Outdoor Thermistor Error	74	23
Current sensor Error	84	24
Trip detection	94	25
Compressor rotor position detection Error	95	26
Outdoor Unit Fan Motor Error	97	27
4-way Valve Error	99	28
Discharge Temp. Error	A1	29
Compressor Temp. Error	A3	30

2-2 TROUBLE SHOOTING WITH ERROR CODE

Trouble shooting 1
OUTDOOR UNIT Error Method:
Serial communication error
(Serial Reverse Transfer Error)

Indicate or Display:

Error code : 11

Outdoor unit : No indication

Detective Actuators:

Outdoor unit Main PCB
 Outdoor unit fan motor

Detective details:

When the indoor unit cannot receive the serial signal from Outdoor unit more than 2minutes after power ON, or the indoor unit cannot receive the serial signal more than 15seconds during normal operation.

Forecast of Cause:

1. Connection failure 2. External cause 3. Main PCB failure 4. Outdoor unit fan motor failure

Check Point 1-1 : Reset the power and operate

· Does Error indication show again?

YES

NO

Check Point 2 : Check Connection

· Check any loose or removed connection line of Indoor unit and Outdoor unit.
 >> **If there is an abnormal condition, correct it by referring to Installation Manual or Data & Technical Manual.**

Check Point 1-2: Check external cause such as noise

· Check the complete insulation of the grounding.
 · Check if there is any equipment that causes harmonic wave near the power cable (Neon light bulb or any electronic equipment which causes harmonic wave).

OK

Check Point 3 : Check the voltage of power supply

· Check the voltage of power supply
 >> **Check if AC198V (AC220V -10%) - 264V (AC240V +10%) appears at Outdoor Unit Terminal L - N.**



OK

Check Point 4 : Check Serial Signal (Reverse Transfer Signal)

· Check Serial Signal (Reverse Transfer Signal)
 >> **Check if Indicated value swings between AC90V and AC270V at Outdoor Unit Terminal 1- 3.**
 >> **If it is abnormal, Check Outdoor unit fan motor (PARTS INFORMATION 5)**
 >> **If Outdoor fan motor is abnormal, replace Outdoor unit fan motor and Main PCB.**
 >> **If Outdoor fan motor is normal, replace Main PCB.**

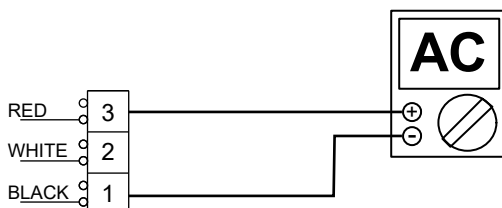

Trouble shooting 2 INDOOR UNIT Error Method: Serial Communication Error (Serial Forward Transfer Error)	Indicate or Display: Error code : 11 Outdoor unit : No indication
--	--

Detective Actuators: Indoor unit Controller PCB	Detective details: When the outdoor unit cannot properly receive the serial signal from indoor unit for 10 seconds or more.
---	---

Forecast of Cause:
1. Connection failure 2. External cause 3. Controller PCB failure

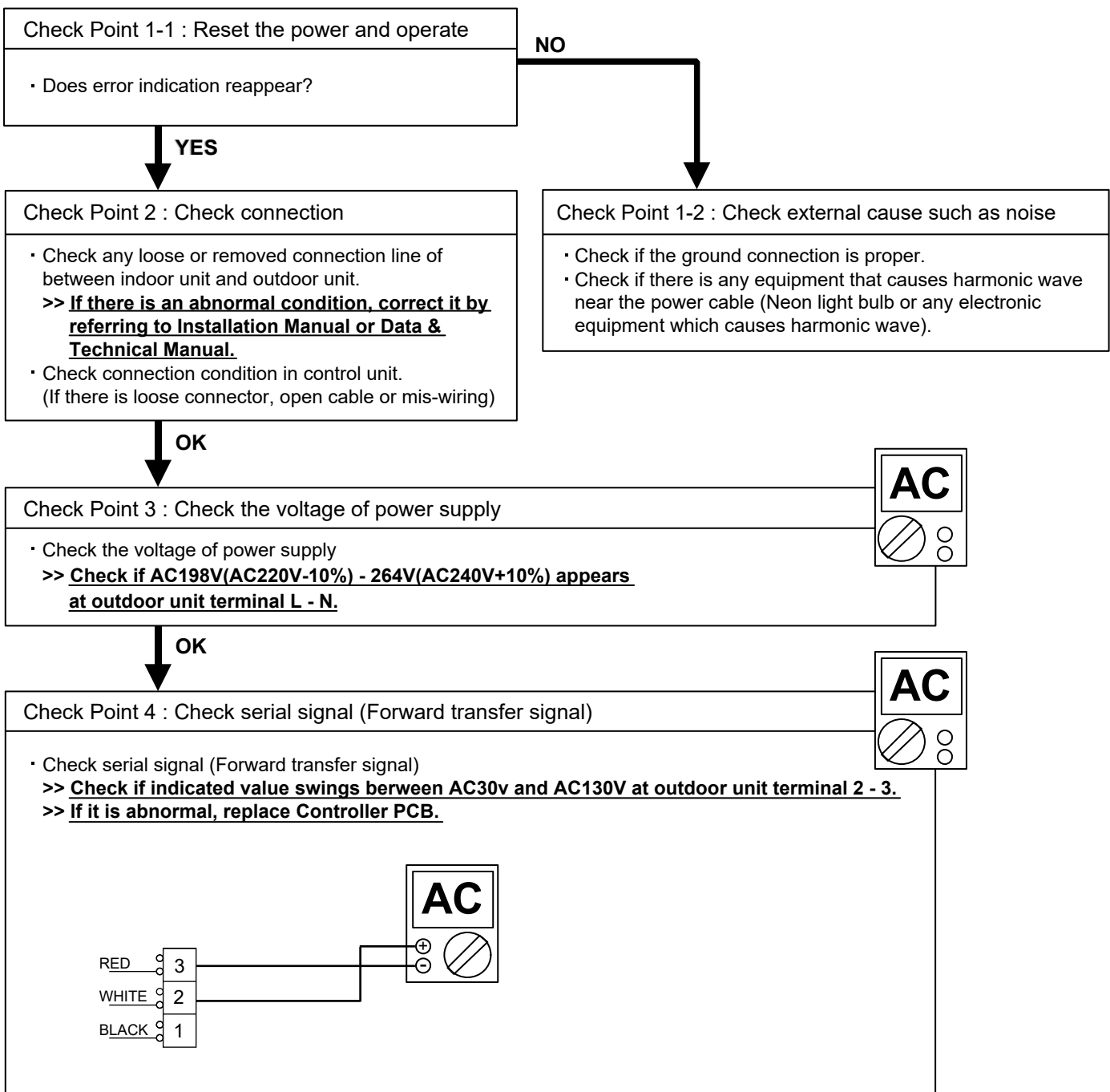

Trouble shooting 3 <u>INDOOR UNIT Error Method:</u> Wired Remote Controller Communication Error	Indicate or Display: Error code : 12 Outdoor unit : No indication
---	--

Detective Actuators: Indoor unit Controller PCB Wired Remote Controller	Detective details: When the indoor unit cannot properly receive the signal from Wired Remote Controller for 1 minute or more.
--	---

Forecast of Cause:
1. Connection failure 2. Wired Remote Controller failure 3. Controller PCB failure

Check Point 1 : Check the connection of terminal

After turning off the power,
Check & correct the followings.

- Check the connection of terminal between Wired Remote Controller and indoor unit, and check if there is a disconnection of the cable.



Check Point 1-2 : Check Wired Remote Controller and Controller PCB

- Ceck Voltage at CN14 of Controller PCB. (Terminal 1-3, Terminal 1-2) (Power supply for the Remote Control)

>> If it is DC13V, Remote Control is failure. (Controller PCB is normal) >> Replace Remote Control
>> If it is DC 0V, Controller PCB is failure. (Check Remote Control once again) >> Replace Controller PCB



Check Point 2 : Wire installation Wrong RCgroup setting

- Wrong wire connection in RCgroup (Please refer to the installation manual)
- The number of connecting indoor unit and Remote controller in one RCgroup were less than 32 units.



Check Point 2-1 : Check Indoor unit controller PCB

- Check if controller PCB damage
- Change controller PCB and check the Error after setting remote controller address

Trouble shooting 4 <u>INDOOR UNIT Error Method:</u> Automatic Air flow Adjustment Error	<u>Indicate or Display:</u> Error code : 15 Outdoor unit : No indication
--	--

<u>Detective Actuators:</u> Indoor unit controller PCB	<u>Detective details:</u> <ul style="list-style-type: none"> ● On automatic airflow adjustment operation, when the fan speed other than 0rpm is detected at the 0rpm operation. ● On automatic airflow adjustment operation, when the fan speed is not reach the target speed, after 2 minutes from the fan started. ● On automatic airflow adjustment operation operation, when the 750W of input power is detected.
--	--

Forecast of Cause:
1. Fan rotation failure 2. Fan motor winding open 3. Indoor unit controller PCB

Check Point 1 : Check rotation of Fan

- Rotate the fan by hand when operation is off.
(Check if fan is caught, dropped off or locked motor)
- >>**If Fan or Bearing is abnormal, replace it.**



Check Point 2 : Check ambient temp. around motor

- Check excessively high temperature around the motor.
(If there is any surrounding equipment that causes heat)
- >>**Upon the temperature coming down, restart operation.**



Check Point 3 : Check Indoor unit fan motor

- Check Indoor unit fan motor. (PARTS INFORMATION 4)
- >>**if Indoor unit fan motor is abnormal, replace Indoor unit fan motor.**



Check Point 4 : Replace Controller PCB

- ▶ **If Check Point 1- 3 do not improve the symptom, replace Controller PCB.**

Trouble shooting 5 INDOOR UNIT Error Method: External communication error	Indicate or Display: Error code : 18 Outdoor unit : No indication
--	--

Detective Actuators: External communication error	Detective details: After receiving a signal from the external I/O PCB, the same a signal has not been received for 15sec
---	--

Forecast of Cause : 1. Connection failure 2.External I/O PCB failure 3.Controller PCB failure

Check Point 1 : Check the connection <ul style="list-style-type: none"> • Check any loose or removed connection of between the controller PCB to the external I/O PCB >>If there is an abnormal condition, correct it by refer to installation manual or the technical manual. • Check the condition condtion on the external I/O PCB and the controller PCB (If there is loose connector, open cable or mis-wiring)

↓
OK

Check Point 2: Replace external I/O PCB ▶ <u>If Check Point 1 do not improve the symptom, change External I/O PCB.</u>

↓
OK

Check Point 3: Replace Controller PCB ▶ <u>If Check Point 2 do not improve the symptom, change Controller PCB.</u>

Trouble shooting 6 <u>INDOOR UNIT Error Method:</u> Combination error	<u>Indicate or Display:</u> Error code : 23 Outdoor unit : No indication
---	--

<u>Detective Actuators:</u> Indoor unit	<u>Detective details:</u> 1. The outdoor unit receives the serial signal of applied refrigerant information from Indoor unit. When the refrigerant is R410a. 2. When the outdoor unit type is multi.
---	---

<u>Forecast of Cause:</u> 1. The selection of indoor units is incorrect

Check Point 1 : Check the type of indoor unit
· Check the type of the connected indoor unit. >> <u>If abnormal condition is found, correct it.</u>



Check Point 2 : Replace Main PCB
▶ <u>If Check Point 1 do not improve the symptom, replace Main PCB of Outdoor unit.</u>

Trouble shooting 7 INDOOR UNIT Error Method: Indoor unit address setting error	Indicate or Display: Error code : 26 <p style="text-align: right;">Outdoor unit : No indication</p>
--	---

Detective Actuators: Wired remote controller (2-Wire) Indoor unit Controller PCB circuit	Detective details: When the address number set by auto setting and manual setting are mixed in one RC group. When the duplicated address number exists in one RC group.
---	--

Forecast of Cause : 1. Wrong wiring of RCgroup 2. Wrong remote address setting 3. Indoor unit controller PCB failure
4. Remote controller failure

Check Point 1 : Wire installation

- Wrong wire connection in RCgroup (Please refer to the installation manual)



Check Point 2 : Wrong RCgroup setting

- The given address number by auto setting (00) and the manual set number (Except 00) were not existing in one RCG.
- The remote controller address setting by U.I. were not existing same address.
- The duplicated address number is not existing in one RCgroup



Check Point 3 : Check Indoor unit controller PCB

- Check if controller PCB damage
- Change controller PCB and check the Error after setting remote controller address

Trouble shooting 8 <u>INDOOR UNIT Error Method:</u> Connection unit number error (Indoor unit in Wired remote controller system)	<u>Indicate or Display:</u> Error code : 29 Outdoor unit : No indication
---	--

Detective Actuators: Wired remote controller (2-Wire) Indoor unit Controller PCB circuit	Detective details: When the number of connecting indoor units are out of specified rule.
---	--

Forecast of Cause : 1. Wrong wiring / Number of I.U, RC in RCgroup 2. Indoor unit controller PCB defective

Check Point 1 : Wire installation
<input type="checkbox"/> Wrong number of connecting indoor unit



Check Point 2 : Check Indoor unit controller PCB
<input type="checkbox"/> Check if controller PCB damage <input type="checkbox"/> Check if controller PCB and check the Error after setting remote controller address

Trouble shooting 9 <u>INDOOR UNIT Error Method:</u> Indoor unit PCB model information error	<u>Indicate or Display:</u> Error code : 32 Outdoor unit : No indication
---	--

<u>Detective Actuators:</u> Indoor unit Controller PCB	<u>Detective details:</u> When power is on and there is some below case. 1. When model information of EEPROM is incorrect. 2. When the access to EEPROM failed.
--	---

<u>Forecast of Cause:</u> 1. External cause 2. Defective connection of electric components 3. Controller PCB failure
--

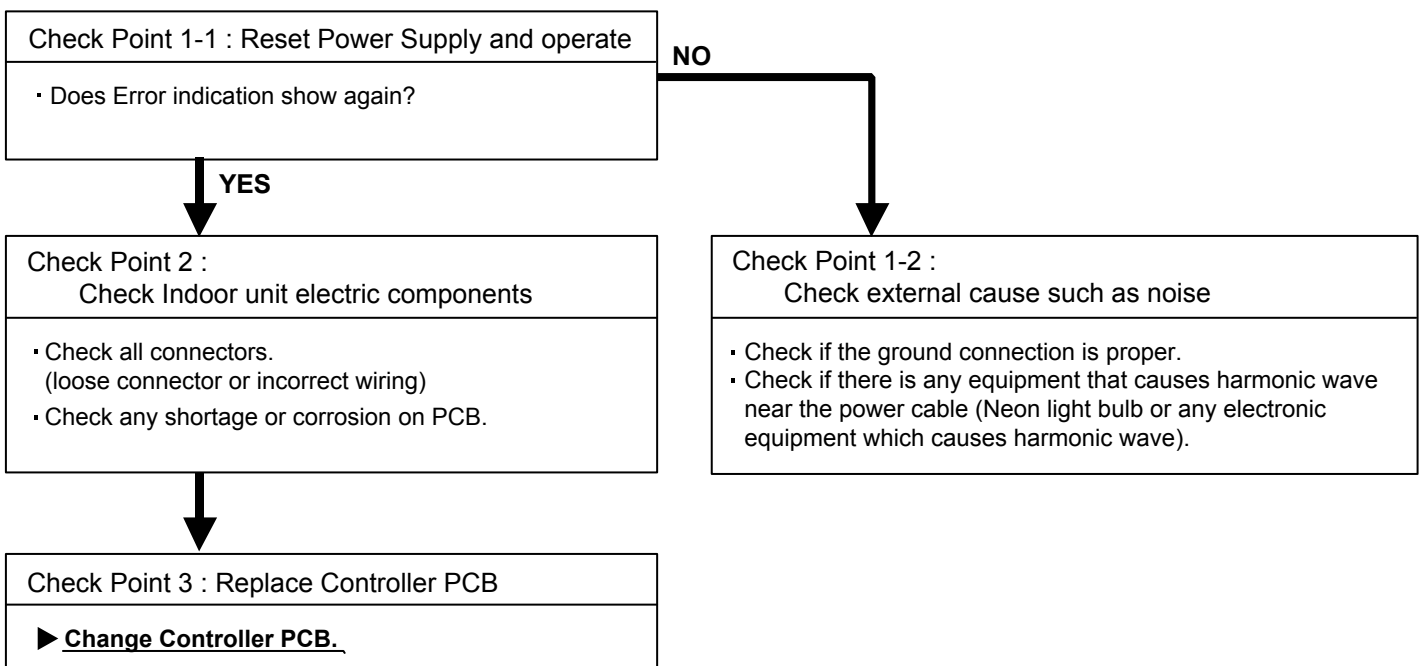

Note : EEPROM

EEPROM(Electronically Erasable and Programmable Read Only Memory) is a non-volatile memory which keeps memorized information even if power is turned off. It can change the contents electronically. To change the contents, it uses higher voltage than normal, and it can not change a partial contents. (Rewriting shall be done upon erasing the all contents.) There is a limit in a number of rewriting.

<p>Trouble shooting 10 <u>INDOOR UNIT Error Method:</u> Indoor unit motor electricity consumption detection error</p>	<p><u>Indicate or Display:</u></p> <p>Error code : 33</p> <p style="text-align: right;">Outdoor unit : No indication</p>
--	--

<p><u>Detective Actuators:</u></p> <p>Indoor unit motor electricity consumption detection error</p>	<p><u>Detective details:</u></p> <p>When the voltage value or the current value of the motor go beyond the limits.</p>
--	---

<p><u>Forecast of Cause:</u></p> <p>1. Fan motor failure 2. Main PCB failure</p>

<p>Check Point 1 : Check rotation of Fan</p>
<p>· Rotate the fan by hand when operation is off. (Check if fan is caught, dropped off or locked motor) >><u>If Fan or Bearing is abnormal, replace It.</u></p>



<p>Check Point 2 : Check ambient temp. around motor</p>
<p>· Check excessively high temperature around the motor. (if there is any surrounding equipment that causes heat) >><u>Upon the temperature coming down, restart operation.</u></p>



<p>Check Point 3 : Check Indoor unit fan motor</p>
<p>· Check Indoor unit fan motor. (PARTS INFORMATION 4) >><u>if Indoor unit fan motor is abnormal, replace Indoor unit fan motor.</u></p>



<p>Check Point 4 : Replace Power Supply PCB</p>
<p>▶ <u>If Check Point 1- 3 do not improve the symptom, replace Main PCB.</u></p>

Trouble shooting 11 INDOOR UNIT Error Method: Indoor unit power supply error for fan motor	Indicate or Display: Error code : 39 Outdoor unit : No indication
--	--

Detective Actuators: Indoor Unit Power Supply PCB	Detective details: When a momentary power cut off. When do not start fan motor.
---	--

Forecast of Cause : 1. External cause 2. Connection of connector failure 3. Power Supply PCB failure
--

Check Point 1 : Check external cause at Indoor and Outdoor (Voltage drop or Noise)
<ul style="list-style-type: none"> • Instant drop : Check if there is a large load electric apparatus in the same circuit. • Momentary power failure : Check if there is a defective contact or leak current in the power supply circuit. • Noise : Check if there is any equipment causing harmonic wave near electric line. (Neon bulb or electric equipment that may cause harmonic wave) Check the complete insulation of grounding.



Check Point 2 : Check connection of Connector
<ul style="list-style-type: none"> • Check if connector is removed. • Check erroneous connection. • Check if cable is open. <p>>>Upon correcting the removed connector or mis-wiring, reset the power.</p>



Check Point 3 : Replace Power supply PCB
<p>► If Check Point 1, 2 do not improve the symptom, replace Power supply PCB.</p>

Trouble shooting 12 INDOOR UNIT Error Method: Indoor unit Communication circuit (wired remote controller) error	Indicate or Display: Error code : 3A <p style="text-align: right;">Outdoor unit : No indication</p>
--	---

Detective Actuators: Indoor unit Controller PCB circuit	Detective details: Detect the communication error of microcomputer and communication PCB.
---	---

Forecast of Cause : 1.Communication PCB defective
 2. Indoor unit controller PCB defective

Check Point 1 : Check the connection of terminal

After turning off the power supply, check & correct the followings

- Indoor unit - Check the connection the communication PCB and the controller PCB



Check Point 2 : Replace the communication PCB

If the Check point 1 is ok, replace the communication PCB



Check Point 3 : Replace the controller PCB

If condition is doesn't change, replace the controller PCB

Trouble shooting 13 INDOOR UNIT Error Method: Indoor Room Thermistor Error	Indicate or Display: Error code : 41 Outdoor unit : No indication
---	---

Detective Actuators: Indoor Unit Controller PCB Circuit Indoor Temperature Thermistor	Detective details: Indoor unit thermistor is open or short is detected always.
--	--

Forecast of Cause : 1. Connector failure connection 2. Thermistor failure 3. Controller PCB failure

Check Point 1 : Check connection of Connector

- Check if connector is loose or removed
- Check erroneous connection
- Check if thermistor cable is open

>>Reset Power when reinstalling due to removed connector or incorrect wiring.



Check Point 2 : Remove connector and check Thermistor resistance value								
Thermistor Characteristics(Rough value)								
Temperature (°C)	0	5	10	15	20	25	30	35
Resistance value (kΩ)	33.6	25.9	20.2	15.8	12.5	10.0	8.0	6.5
Temperature (°C)	40	45	50					
Resistance value (kΩ)	5.3	4.35	3.59					
► If Thermistor is either open or shorted, replace it and reset the power.								



Check Point 3 : Check Voltage of Controller PCB (DC 5.0V)		
Make sure circuit diagram of each indoor unit and check terminal voltage at Thermistor (DC5.0V)		
CN32 1 2 CN8 1 2		
► If the voltage does not appear, replace Controller PCB and execute the check operation again.		

Trouble shooting 14 INDOOR UNIT Error Method: Indoor Heat Ex. middle temp. sensor Error	Indicate or Display: Error code : 42 <p style="text-align: right;">Outdoor unit : No indication</p>
---	---

Detective Actuators: Indoor Unit Controller PCB Heat Exchanger (MID) Thermistor	Detective details: Indoor unit thermistor is open or short is detected always.
--	--

Forecast of Cause : 1. Connector failure connection 2. Thermistor failure 3. Controller PCB failure

Check Point 1 : Check connection of Connector

- Check if connector is loose or removed
- Check erroneous connection
- Check if thermistor cable is open

>>Reset Power when reinstalling due to removed connector or incorrect wiring.



Check Point 2 : Remove connector and check Thermistor resistance value

Thermistor Characteristics(Rough value)

Temperature (°C)	0	5	10	15	20	25	30	35
Resistance value (kΩ)	176	134	103	80.3	62.9	49.7	39.6	31.7

Temperature (°C)	40	45	50
Resistance value (kΩ)	25.6	20.8	17.1

► If Thermistor is either open or shorted, replace it and reset the power.



Check Point 3 : Check voltage of Controller PCB (DC5.0V)

Make sure circuit diagram of each indoor unit and check terminal voltage at Thermistor (DC5.0V)

► If the voltage does not appear, replace Controller PCB and execute the check operation again.

Trouble shooting 15 INDOOR UNIT Error Method: Indoor Unit Fan Motor Error	Indicate or Display: Error code : 51 Outdoor unit : No indication
--	--

Detective Actuators: Indoor unit Power Supply PCB Indoor unit fan motor	Detective details: When the fan motor speed is less than 1/3 of the target fan speed for 56 seconds. When detect the 0 rpm for 56 seconds after fan motor started.
--	---

Forecast of Cause: 1. Fan rotation failure 2. Fan motor winding open 3. Motor protection by surrounding temperature rise 4. Power Supply PCB failure 5. Indoor unit fan motor failure
--

Check Point 1 : Check rotation of Fan
· Rotate the fan by hand when operation is off. (Check if fan is caught, dropped off or locked motor) >>If Fan or Bearing is abnormal, replace It.



Check Point 2 : Check ambient temp. around motor
· Check excessively high temperature around the motor. (if there is any surrounding equipment that causes heat) >>Upon the temperature coming down, restart operation.



Check Point 3 : Check Indoor unit fan motor
· Check Indoor unit fan motor. (PARTS INFORMATION 4) >>if Indoor unit fan motor is abnormal, replace Indoor unit fan motor.



Check Point 4 : Replace Power Supply PCB
▶ If Check Point 1- 3 do not improve the symptom, replace Power Supply PCB.

Trouble shooting 16 <u>INDOOR UNIT Error Method:</u> Drain pump Error	<u>Indicate or Display:</u> Error code : 53 Outdoor unit : No indication
--	---

<u>Detective Actuators:</u> Indoor Unit Controller PCB Circuit Float Switch	<u>Detective details:</u> When Float switch is ON for more than 3 minutes.
--	--

Forecast of Cause : 1. Float switch failure 2. Shorted connector/wire 3. Controller PCB failure
4. Drain pump failure 5. Hose clogging

Check Point 1 : Check Float Switch

- Check operation of float switch. (any blocking by dust, etc.)
- Remove Float switch and check ON/OFF switching operation by using a meter.
>>If Float switch is abnormal, replace it.

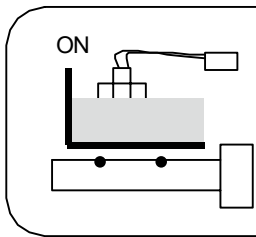
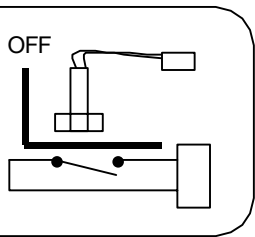

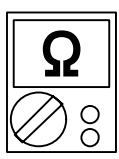
OK
↓

Check Point 2 : Check Connector and Wire

- Check loose contact of CN9 and shorted wire (pinched wire).
>>Replace Float switch if the wire is abnormal

OK
↓

Check Point 3 : Check Drain Hose

- Check Drain Hose .
>>If there is Hose clogging. Please clear the clog.

OK
↓

Check Point 4 : Check Controller PCB and Drain Pump

- Check Drain Pump.
If drain pump is not run on the working condition, check the voltage of the CN71 on the controller PCB.

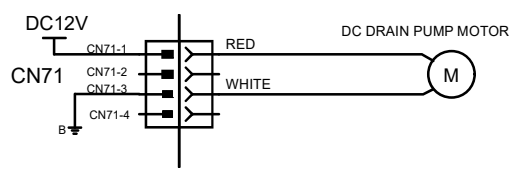

Measurement result
12V : Replace the Drain Pump
Other than 12V : Replace the controller PCB

Trouble shooting 18 <u>OUTDOOR UNIT Error Method:</u> Inverter error	<u>Indicate or Display:</u> Error code : 63 Outdoor unit : No indication
--	--

<u>Detective Actuators:</u> Outdoor unit Main PCB	<u>Detective details:</u> • Error information received from Outdoor unit Main PCB
---	---

<u>Forecast of Cause :</u> 1. External cause. 2. Power supply to Main PCB wiring disconnection, open 3. Outdoor unit Main PCB failure

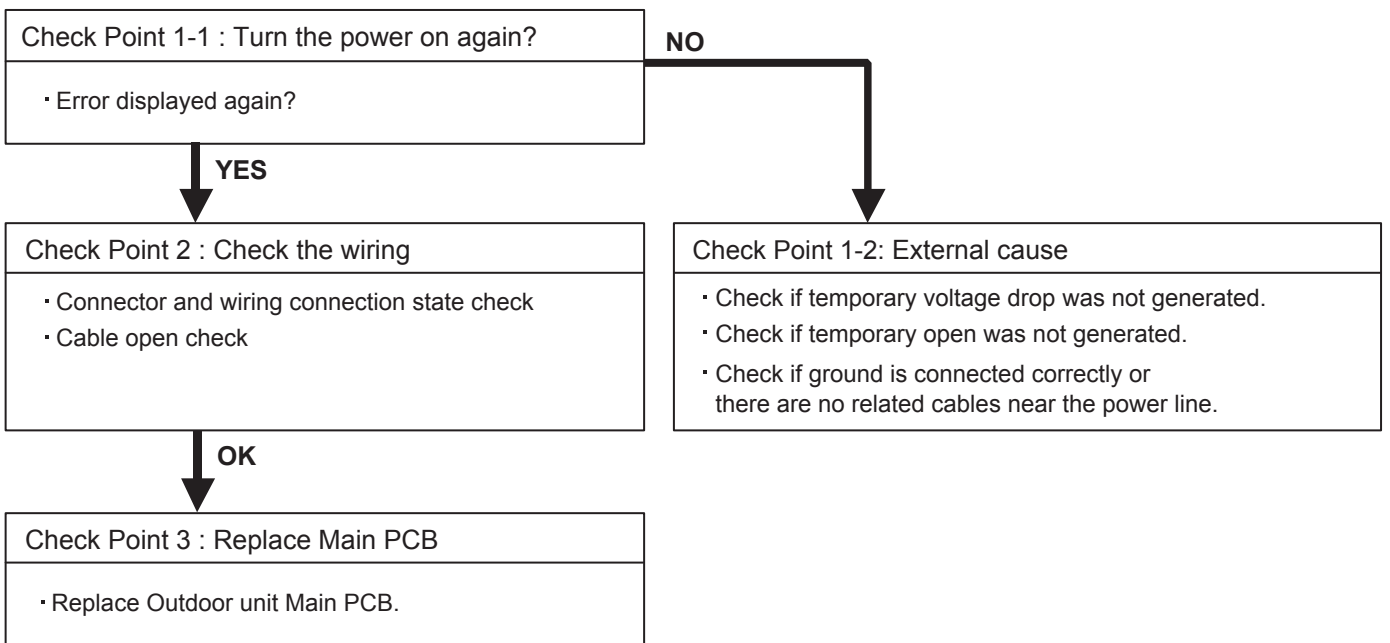

Trouble shooting 19 <u>OUTDOOR UNIT Error Method:</u> PFC circuit error	<u>Indicate or Display:</u> Error code : 64 Outdoor unit : No indication
--	--

<u>Detective Actuators:</u> Outdoor unit Main PCB	<u>Detective details:</u> When inverter output DC voltage is higher than 420V for over 3 seconds, the compressor stops. If the same operation is repeated 5 times, the compressor stops permanently.
---	---

<u>Forecast of Cause :</u> 1. External cause 2. Connector connection failure 3. Main PCB failure
--

Check Point 1 : Check external cause at Indoor and Outdoor (Voltage drop or Noise) <ul style="list-style-type: none"> • Instant drop : Check if there is a large load electric apparatus in the same circuit. • Momentary power failure : Check if there is a defective contact or leak current in the power supply circuit. • Noise : Check if there is any equipment causing harmonic wave near electric line. (Neon bulb or electric equipment that may cause harmonic wave) Check the complete insulation of grounding.
--



Check Point 2 : Check connection of Connector <ul style="list-style-type: none"> • Check if connector is removed. • Check erroneous connection. • Check if cable is open. >><u>Upon correcting the removed connector or mis-wiring, reset the power.</u>
--



Check Point 3 : Replace Main PCB ▶ <u>If Check Point 1, 2 do not improve the symptom, change Main PCB.</u>

Trouble shooting 20 <u>OUTDOOR UNIT Error Method:</u> Trip terminal L error	<u>Indicate or Display:</u> Error code : 65 Outdoor unit : No indication
--	--

<u>Detective Actuators:</u> Outdoor unit Main PCB	<u>Detective details:</u> When the signal from FO terminal (13-15) of IPM is"L"(=0V) while the compressor stops.
---	--

<u>Forecast of Cause:</u> 1. Outdoor unit Main PCB failure
--

Check Point 1 : Replace Main PCB
▶ <u>Replace Outdoor unit Main PCB.</u>

Trouble shooting 21 OUTDOOR UNIT Error Method: Discharge Thermistor Error	Indicate or Display: Error code : 71 Outdoor unit : No indication
--	--

Detective Actuators: Discharge temperature thermistor	Detective details: <ul style="list-style-type: none"> • Discharge temperature thermistor short detected • Discharge thermistor open detected
---	---

Forecast of Cause : <ol style="list-style-type: none"> 1. Connector connection failure, open 2. Thermistor failure 3. Main PCB failure
--

Check Point 1 : Check the connector connection and cable open
<input type="checkbox"/> Connector connection state check <input type="checkbox"/> Cable open check

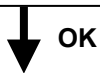

Check Point 2 : Check the thermistor
<input type="checkbox"/> Thermistor characteristics check (Disconnect the thermistor from the PCB and check.) * For the thermistor characteristics, refer to the "Service Parts Information 8".



Check Point 3 : Check voltage of Main PCB (DC5.0V)	<div style="border: 1px solid black; padding: 5px; width: fit-content; margin: 0 auto;"> DC  </div>
<input type="checkbox"/> Main PCB P1 :3-4 voltage value =5V <u>Remove the thermistor from Main PCB, check the voltage.</u>	

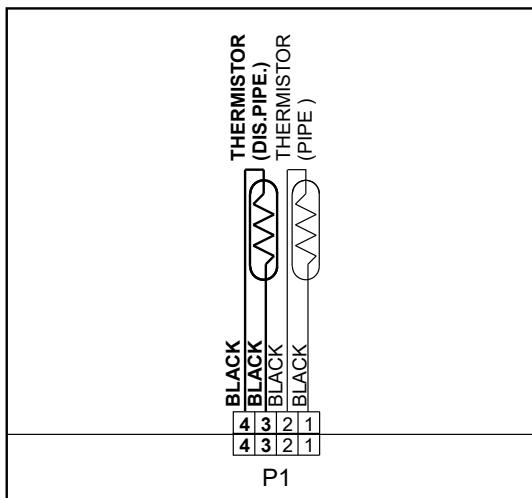

▶ **If the voltage does not appear, replace Main PCB, and execute the check operation again.**

Trouble shooting 22 OUTDOOR UNIT Error Method: Heat Ex.(Middle/Outlet) Temp. Thermistor Error	Indicate or Display: Error code : 73 Outdoor unit : No indication
--	--

Detective Actuators: Heat exchanger liquid temperature thermistor Heat exchanger middle temperature thermistor	Detective details: <ul style="list-style-type: none"> • Heat exchanger liquid temperature thermistor short or open detected • Heat exchanger middle temperature thermistor short or open detected
---	--

Forecast of Cause : <ol style="list-style-type: none"> 1. Connector connection defective, open 2. Thermistor failure 3. Main PCB failure
--

Check Point 1 : Check the connector connection and cable open
<input type="checkbox"/> Connector connection state check <input type="checkbox"/> Cable open check



Check Point 2 : Check the thermistor
<input type="checkbox"/> Thermistor characteristics check (Disconnect the thermistor from the PCB and check.) * For the thermistor characteristics, refer to the "Service Parts Information 8".



Check Point 3 : Check voltage of Main PCB (DC5.0V)	<div style="border: 1px solid black; padding: 5px; display: inline-block;"> DC </div>
<input type="checkbox"/> Main PCB P1 :1-2 voltage value =5V and P10 :1-2 voltage value =5V <u>Remove the thermistor from Main PCB, check the voltage.</u>	

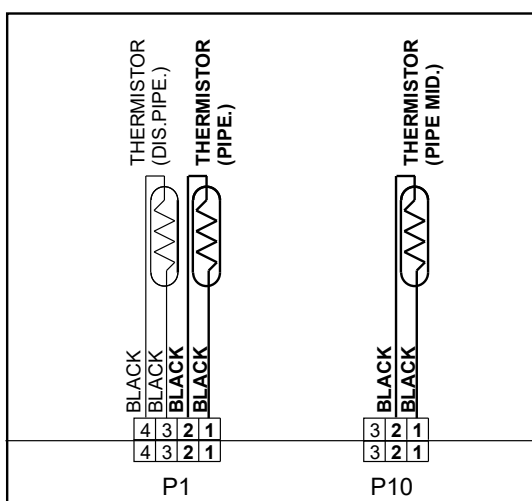

► If the voltage does not appear, replace Main PCB, and execute the check operation again.

Trouble shooting 23 <u>OUTDOOR UNIT Error Method:</u> Outdoor Thermistor Error	<u>Indicate or Display:</u> Error code : 74 Outdoor unit : No indication
---	--

<u>Detective Actuators:</u> Outdoor temperature thermistor	<u>Detective details:</u> <ul style="list-style-type: none"> Outdoor temperature thermistor short or open detected
--	---

<u>Forecast of Cause :</u> <ol style="list-style-type: none"> Connector connection defective, open Thermistor failure Main PCB failure
--

Check Point 1 : Check the connector connection and cable open
<input type="checkbox"/> Connector connection state check <input type="checkbox"/> Cable open check



Check Point 2: Check the thermistor
<input type="checkbox"/> Thermistor characteristics check (Disconnect the thermistor from the PCB and check.) * For the thermistor characteristics, refer to the "Service Parts Information 8".

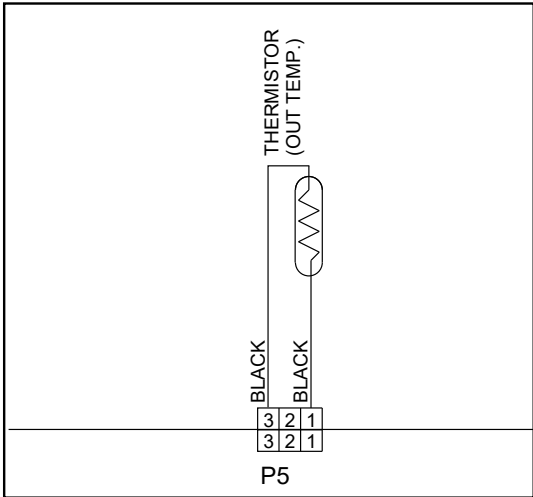

Check Point 3 : Check voltage of Main PCB (DC5.0V)	<div style="border: 1px solid black; padding: 2px; display: inline-block;">DC</div> 
<input type="checkbox"/> Main PCB P5 :1-3 voltage value =5V <u>Remove the thermistor from Main PCB, check the voltage.</u>	
	
<p>▶ <u>If the voltage does not appear, replace Main PCB, and execute the check operation again.</u></p>	

Trouble shooting 24 OUTDOOR UNIT Error Method: Current sensor error	Indicate or Display: Error code : 84 Outdoor unit : No indication
--	---

Detective Actuators: Outdoor unit Main PCB	Detective details: When Input Current Sensor has detected 0A, while Inverter Compressor is operating at higher than 56rps, after 1minute upon starting the Compressor. (Except during the defrost operation)
--	--

Forecast of Cause : 1. Defective connection of electric components 2. External cause 3. Main PCB failure
--

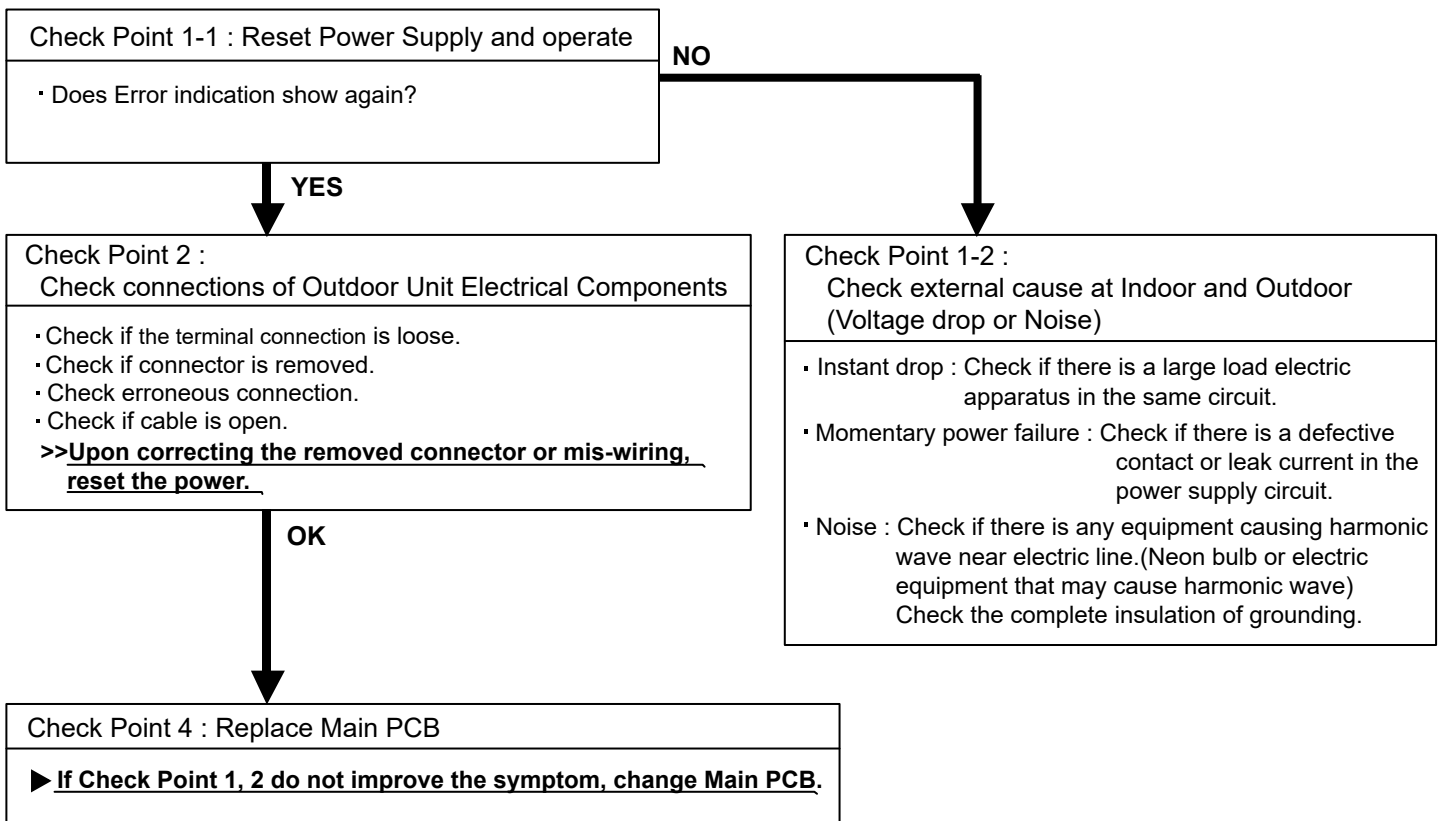

Trouble shooting 25 OUTDOOR UNIT Error Method: Trip detection	<u>Indicate or Display:</u> Error code : 94 Outdoor unit : No indication
--	---

<u>Detective Actuators:</u> Outdoor unit Main PCB Compressor	<u>Detective details:</u> ▪ "Protection stop by overcurrent generation after inverter compressor start processing completed" generated consecutively 10 times. * The number of generations is reset if the start-up of the compressor succeeds.
--	--

<u>Forecast of Cause :</u> <ol style="list-style-type: none"> 1. Outdoor unit fan operation defective, foreign matter on hear exchanger, excessive rise of ambient temperature 2. Main PCB 3. Inverter compressor failure (lock, winding short)
--

Check Point 1 : Check the outdoor unit fan operation, heat exchanger, ambient temperature
<ul style="list-style-type: none"> • No obstructions in air passages? • Heat exchange fins clogged • Outdoor unit fan motor check • Ambient temperature not raised by the effect of other heat sources? • Discharged air not sucked in?

↓ **OK**

Check Point 2: Replace Main PCB
▶ <u>If Check Point 1 do not improve the symptom, change Main PCB.</u>

↓ **OK**

Check Point 3: Replace Compressor
▶ <u>If Check Point 2 do not improve the symptom, change Compressor.</u>

<p>Trouble shooting 26 <u>OUTDOOR UNIT Error Method:</u> Compressor rotor position detection error</p>	<p><u>Indicate or Display:</u></p> <p>Error code : 95 Outdoor unit : No indication</p>
---	---

<p><u>Detective Actuators:</u></p> <p>Outdoor unit Main PCB Compressor</p>	<p><u>Detective details:</u></p> <p>① While running the compressor, if the detected rotor location is out of phase with actual rotor location more than 105°, the compressor stops. ② After the compressor restarts, if the same operation is repeated within 40sec, the compressor stops again. ③ If ① and ② repeats 5 times, the compressor stops permanently.</p>
---	---

<p><u>Forecast of Cause :</u></p> <p>1. Defective connection of electric components 2. Main PCB failure 3. Compressor failure</p>
--

<p>Check Point 1 : Check Noise from Compressor</p>
<ul style="list-style-type: none"> • Turn on Power and check operation noise. <p>▶ <u>If an abnormal noise show, replace Compressor.</u></p>



<p>Check Point 2 : Check connection of around the Compressor components</p>
<p>For Compressor Terminal, Main PCB</p> <ul style="list-style-type: none"> • Check if connector is removed. • Check erroneous connection. • Check if cable is open. <p>(Refer to PARTS INFORMATION 2)</p> <p>>><u>Upon correcting the removed connector or mis-wiring, reset the power.</u></p>



<p>Check Point 3: Replace Main PCB</p>
<p>▶ <u>If Check Point 1,2 do not improve the symptom, change Main PCB.</u></p>



<p>Check Point 4: Replace Compressor</p>
<p>▶ <u>If Check Point 3 do not improve the symptom, change Compressor.</u></p>

Trouble shooting 27 OUTDOOR UNIT Error Method: Outdoor Unit Fan Motor Error	Indicate or Display: Error code : 97 Outdoor unit : No indication
--	---

Detective Actuators: Outdoor unit Main PCB Outdoor unit fan motor	Detective details: ① When outdoor fan rotation speed is less than 100rpm in 20 seconds after fan motor starts, fan motor stops. ② After fan motor restarts, if the same operation within 60sec is repeated 3 times in a row, compressor and fan motor stops. ③ If ① and ② repeats 5 times in a row, compressor and fan motor stops permanently.
--	---

Forecast of Cause: 1. Fan rotation failure 2. Motor protection by surrounding temperature rise 3. Main PCB failure 4. Outdoor unit fan motor failure

Check Point 1 : Check rotation of Fan
<ul style="list-style-type: none"> Rotate the fan by hand when operation is off. (Check if fan is caught, dropped off or locked motor) >>If Fan or Bearing is abnormal, replace it.

↓
OK

Check Point 2 : Check ambient temp. around motor
<ul style="list-style-type: none"> Check excessively high temperature around the motor. (If there is any surrounding equipment that causes heat) >>Upon the temperature coming down, restart operation.

↓
OK

Check Point 3 : Check Outdoor unit fan motor
<ul style="list-style-type: none"> Check Outdoor unit fan motor. (PARTS INFORMATION 5) >>If Outdoor Fan Motor is abnormal, replace Outdoor fan motor and Main PCB.

↓
OK

Check Point 4 : Check Output Voltage of Main PCB	DC 						
<ul style="list-style-type: none"> Check outdoor unit circuit diagram and the voltage. (Measure at Main PCB side connector) 							
	<table border="1"> <thead> <tr> <th>Read wire</th> <th>DC voltage</th> </tr> </thead> <tbody> <tr> <td>Red - Black</td> <td>280V (AC220V-10%) ~ 373V (AC240+10%)</td> </tr> <tr> <td>White - Black</td> <td>15 ± 1.5V</td> </tr> </tbody> </table>	Read wire	DC voltage	Red - Black	280V (AC220V-10%) ~ 373V (AC240+10%)	White - Black	15 ± 1.5V
Read wire	DC voltage						
Red - Black	280V (AC220V-10%) ~ 373V (AC240+10%)						
White - Black	15 ± 1.5V						
▶ If the voltage is not correct, replace Main PCB.							

Trouble shooting 28 OUTDOOR UNIT Error Method: 4-Way Valve Error	<u>Indicate or Display:</u> Error code : 99 Outdoor unit : No indication
---	--

<u>Detective Actuators:</u> Indoor Unit Controller PCB Circuit Heat Exchanger Temperature Thermistor Room Temperature Thermistor 4-way valve	<u>Detective details:</u> When the indoor heat exchanger temperature is compared with the room temperature, and either following condition is detected continuously two times, the compressor stops. <ul style="list-style-type: none"> •Cooling or Dry operation [Indoor heat exchanger temp.] - [Room temp.] > 20°C •Heating operation [indoor heat exchanger temp.] - [Room temp.] < -14°C If the same operation is repeated 5 times, the compressor stops permanently.
--	---

<u>Forecast of Cause :</u> 1. Connector connection failure 2. Thermistor failure 3. Coil failure 4. 4-way valve failure 5. Main PCB failure
--

Check Point 1 : Check connection of Connector
<ul style="list-style-type: none"> • Check if connector is removed. • Check erroneous connection. • Check if thermistor cable is open. >> <u>Upon correcting the removed connector or mis-wiring, reset the power.</u>



Check Point 2 : Check thermistor of Indoor unit
<ul style="list-style-type: none"> • Isn't it fallen off the holder? • Is there a cable pinched? >> <u>Check characteristics of thermistor, (Refer to Trouble shooting 13,14), If defective, replace the thermistor.</u>



Check Point 3 : Check the solenoid coil and 4-way valve
[Solenoid coil] <ul style="list-style-type: none"> • Remove P60 from PCB and check the resistance value of coil. Resistance value is about 2.1kΩ >> <u>If it is Open or abnormal resistance value, replace Solenoid Coil.</u>
[4-way valve] <ul style="list-style-type: none"> • Check each piping temperature, and the location of the valve by the temperature difference. >> <u>If the value location is not proper, replace 4-way valve.</u>



Check Point 4 : Replace Main PCB
▶ <u>If Check Point 1- 3 do not improve the symptom, replace Main PCB.</u>

Trouble shooting 29 OUTDOOR UNIT Error Method: Discharge Temp. Error	Indicate or Display: Error code : A1 Outdoor unit : No indication
---	---

Detective Actuators: Discharge temperature thermistor	Detective details: <ul style="list-style-type: none"> ▪ "Protection stop by "discharge temperature $\geq 115^{\circ}\text{C}$ during compressor operation"" generated 2 times within 24 hours.
---	--

Forecast of Cause : <ol style="list-style-type: none"> 1. 3-way valve not opened 2. EEV defective, strainer clogged 3. Outdoor unit operation failure, foreign matter on heat exchanger 4. Discharge temperature thermistor failure 5. Insufficient refrigerant

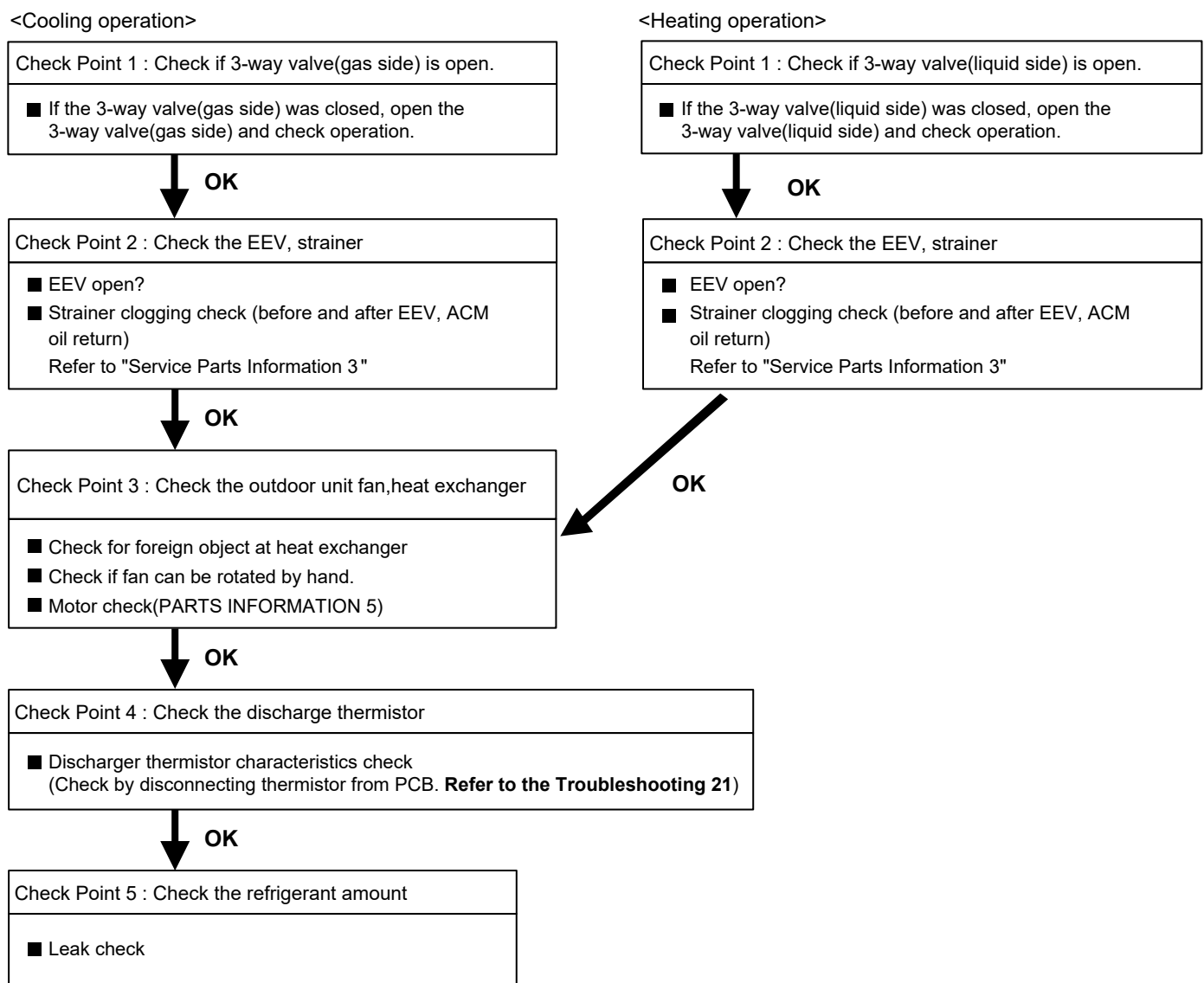

Trouble shooting 30 OUTDOOR UNIT Error Method: Compressor Temp. Error	Indicate or Display: Error code : A3 Outdoor unit : No indication
--	---

Detective Actuators: Compressor temperature thermistor	Detective details: ▪ "Protection stop by "compressor temperature" $\geq 110^{\circ}\text{C}$ during compressor operation""generated 2 times within 24 hours
--	---

Forecast of Cause : <ol style="list-style-type: none"> 1. 3-way valve not opened 2. EEV defective, strainer clogged 3. Outdoor unit operation failure, foreign matter on heat exchanger 4. Compressor temperature thermistor failure 5. Insufficient refrigerant
--

<Cooling operation>

Check Point 1 : Check if 3-way valve(gas side) is open.
<input type="checkbox"/> If the 3-way valve(gas side) was closed, open the 3-way valve(gas side) and check operation.

↓ **OK**

Check Point 2 : Check the EEV, strainer
<input type="checkbox"/> EEV open? <input type="checkbox"/> Strainer clogging check (before and after EEV, ACM oil return) Refer to "Service Parts Information 3".

↓ **OK**

Check Point 3 : Outdoor unit fan, heat exchanger check
<input type="checkbox"/> Check for foreign object at heat exchanger <input type="checkbox"/> Check if fan can be rotated by hand. <input type="checkbox"/> Motor check(PARTS INFORMATION 5)

↓ **OK**

Check Point 5 : Check the refrigerant amount
<input type="checkbox"/> Leak check

<Heating operation>

Check Point 1 : Check if 3-way valve(liquid side) is open.
<input type="checkbox"/> If the 3-way valve(liquid side) was closed, open the 3-way valve(liquid side) and check operation.

↓ **OK**

Check Point 2 : Check the EEV, strainer
<input type="checkbox"/> EEV open? <input type="checkbox"/> Strainer clogging check (before and after EEV, ACM oil return) Refer to "Service Parts Information 3 "

↙ **OK**

2-3 TROUBLE SHOOTING WITH NO ERROR CODE

Trouble shooting 31

Indoor Unit - No Power

Forecast of Cause:

1. Power Supply failure
2. External cause
3. Electrical Components defective

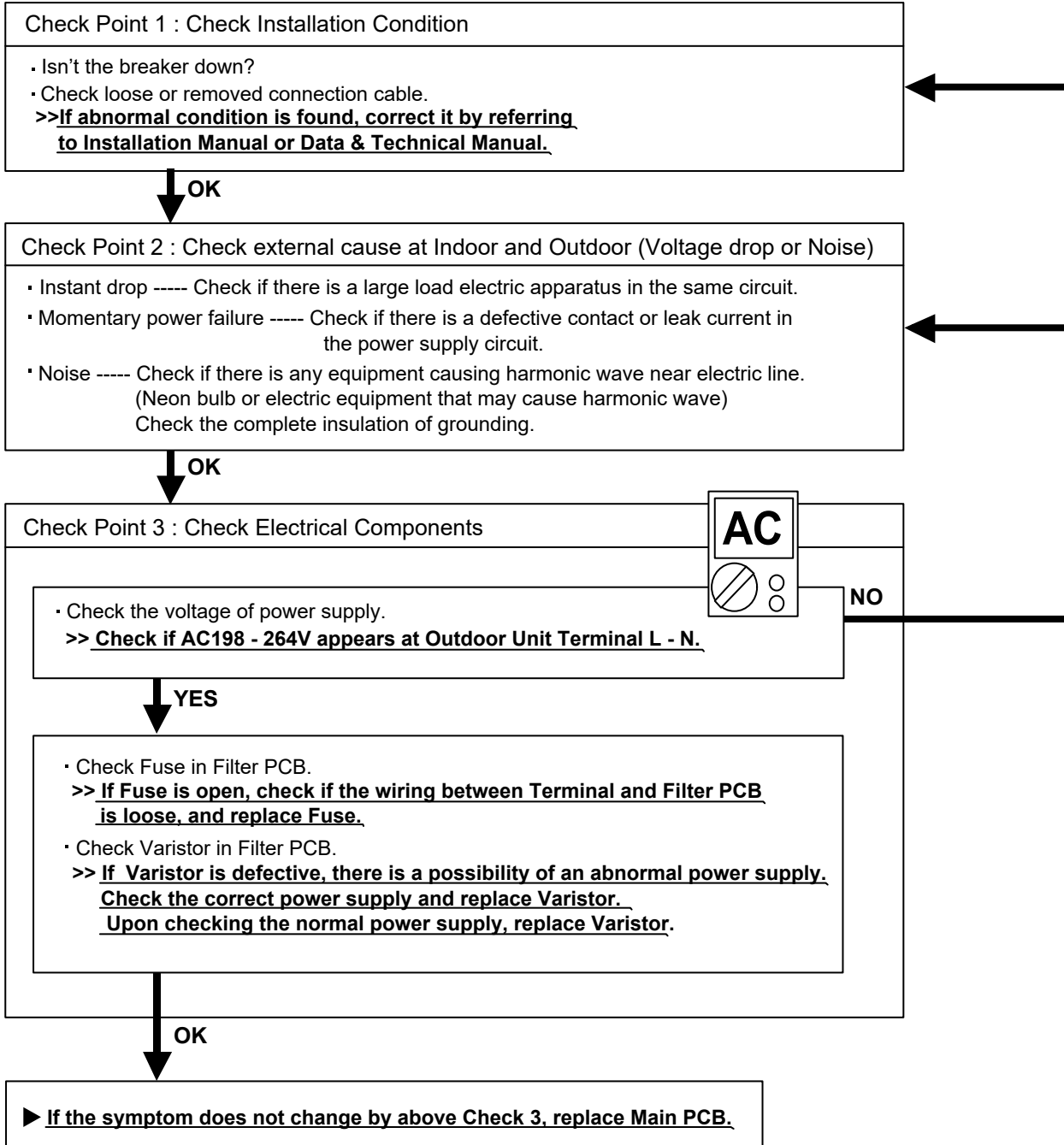

Trouble shooting 32

Outdoor unit - No Power

Forecast of Cause:

1. Power Supply failure
2. External cause
3. Electrical Components defective

Check Point 1 : Check Installation Condition

- Isn't the breaker down?
 - Check loose or removed connection cable.
- >>If abnormal condition is found, correct it by referring to Installation Manual or Data & Technical Manual.**

OK

Check Point 2 : Check external cause at Indoor and Outdoor (Voltage drop or Noise)

- Instant drop ----- Check if there is a large load electric apparatus in the same circuit.
- Momentary power failure ----- Check if there is a defective contact or leak current in the power supply circuit.
- Noise ----- Check if there is any equipment causing harmonic wave near electric line.
(Neon bulb or electric equipment that may cause harmonic wave)
Check the complete insulation of grounding.

OK

Check Point 3 : Check Electrical Components

- Check the voltage of power supply.
- >> Check if AC198 - 264V appears at Outdoor unit Terminal L - N.**

YES

- Check Fuse in Main PCB.
- >> If Fuse is open, check if the wiring between Terminal and Main PCB is loose, and replace Fuse.**

OK

► **If the symptom does not change by above Check 3, replace Main PCB.**

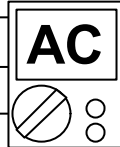

NO

Trouble shooting 33

No Operation (Power is ON)

Forecast of Cause:

1. Setting/ Connection failure
2. External cause
3. Electrical Component defective

Check Point 1 : Check indoor and outdoor installation condition

- Indoor Unit - Check incorrect wiring between Indoor Unit - Remote Control.
Or, check if there is an open cable connection.
- Are these Indoor Unit, Outdoor Unit, and Remote Control suitable model numbers to connect?
>> If there is some abnormal condition, correct it by referring to Installation manual and Data & Technical Manual.

OK

Turn off Power and check/ correct followings.

- Is there loose or removed communication line of Indoor Unit and Outdoor Unit?

OK

Check Point 2 : Check external cause at Indoor and Outdoor (Voltage drop or Noise)

- Instant drop ----- Check if there is a large load electric apparatus in the same circuit.
- Momentary power failure ----- Check if there is a defective contact or leak current in the power supply circuit.
- Noise ----- Check if there is any equipment causing harmonic wave near electric line.
(Neon bulb or electric equipment that may cause harmonic wave)
Check the complete insulation of grounding.

OK

Check Point 3 : Check Wired Remote Controller and Controller PCB



- Check Voltage at CN14 of Controller PCB. (terminal 1-3)
(Power supply to Remote Control)

- >> If it is DC13V, Remote Control is failure. (Controller PCB is normal) >> Replace Remote Control**
- >> If it is DC 0V, Controller PCB is failure. (Check Remote Control once again) >> Replace Controller PCB**
- >> If the symptom does not change by above Check 1, 2, 3, replace Main PCB of Outdoor unit.**

Trouble shooting 34

No Cooling / No Heating

Forecast of Cause:

1. Indoor Unit error
2. Outdoor Unit error
3. Effect by Surrounding environment
4. Connection Pipe / Connection Wire failure
5. Refrigeration cycle failure

Check Point 1 : Check Indoor Unit

- Does Indoor Unit FAN run on HIGH FAN?
- Is Air Filter dirty?
- Is Heat Exchanger clogged?
- Check if Energy save function is operated.



Check Point 2 : Check Outdoor Unit Operation

- Check if Outdoor Unit is operating
- Check any objects that obstruct the air flow route.
- Check clogged Heat Exchanger.
- Is the Valve open?



Check Point 3 : Check Site Condition

- Is capacity of Indoor Unit fitted to Room size?
- Any windows open? Or direct sunlight ?



Check Point 4 : Check Indoor/ Outdoor Installation Condition

- Check connection pipe (specified pipe length & Pipe diameter?)
- Check any loose or removed communication line.
- >> **If there is an abnormal condition, correct it by referring to Installation Manual or Data & Technical Manual.**



Check Point 5 : Check Refrigeration Cycle

- Check if Strainer is clogged (Refer to the figure at right).
- Measure Gas Pressure and if there is a leakage, correct it.
- >> **When recharging the refrigerant, make sure to perform vacuuming, and recharge the specified amount.**
- Check EEV (PARTS INFORMATION 3)
- Check Compressor (PARTS INFORMATION 1,2)

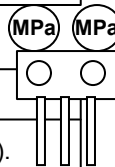

Attention

Strainer normally does not have temperature difference between inlet and outlet as shown in ①, but if there is a difference like shown in ②, there is a possibility of inside clogged. In this case, replace Strainer.

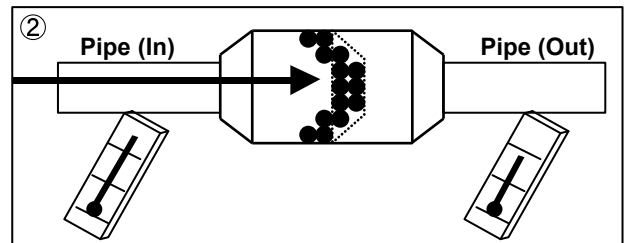
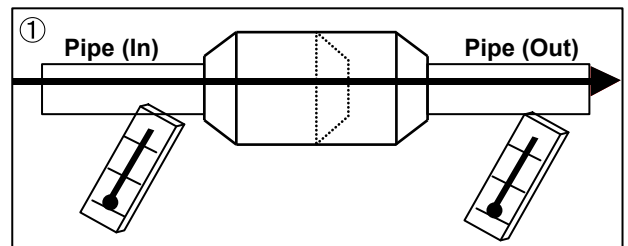

Trouble shooting 35

Abnormal Noise

Forecast of Cause :

1. Abnormal installation (Indoor/ Outdoor)
2. Fan failure (Indoor/ Outdoor)
3. Compressor failure (Outdoor)

Diagnosis method when Abnormal Noise is occurred

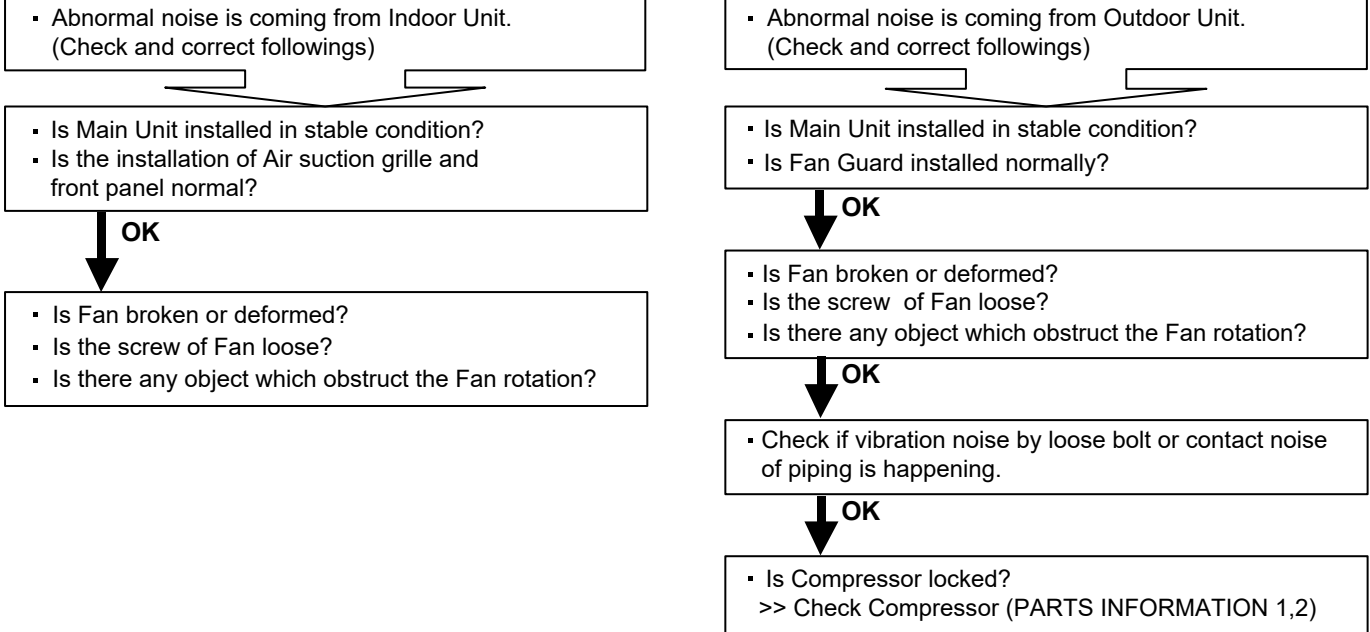

Trouble shooting 36

Water Leaking

Forecast of Cause:

1. Erroneous installation
2. Drain hose failure

Diagnosis method when water leak occurs

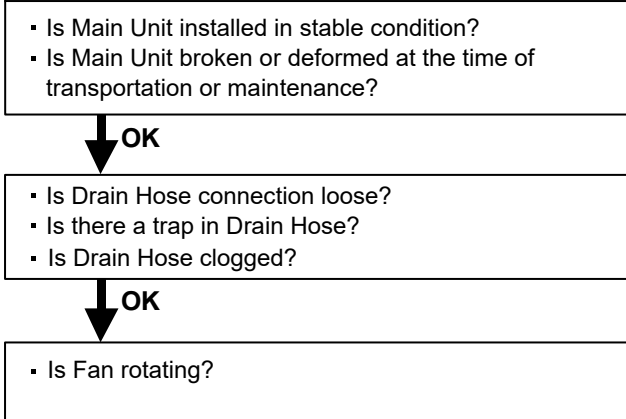

Diagnosis method when water is spitting out.

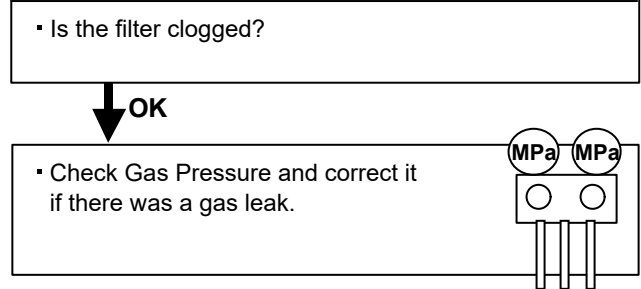

2-4 SERVICE PARTS INFORMATION

SERVICE PARTS INFORMATION 1

Compressor

Diagnosis method of Compressor (If Outdoor Unit LED displays Error, refer to Trouble shooting)

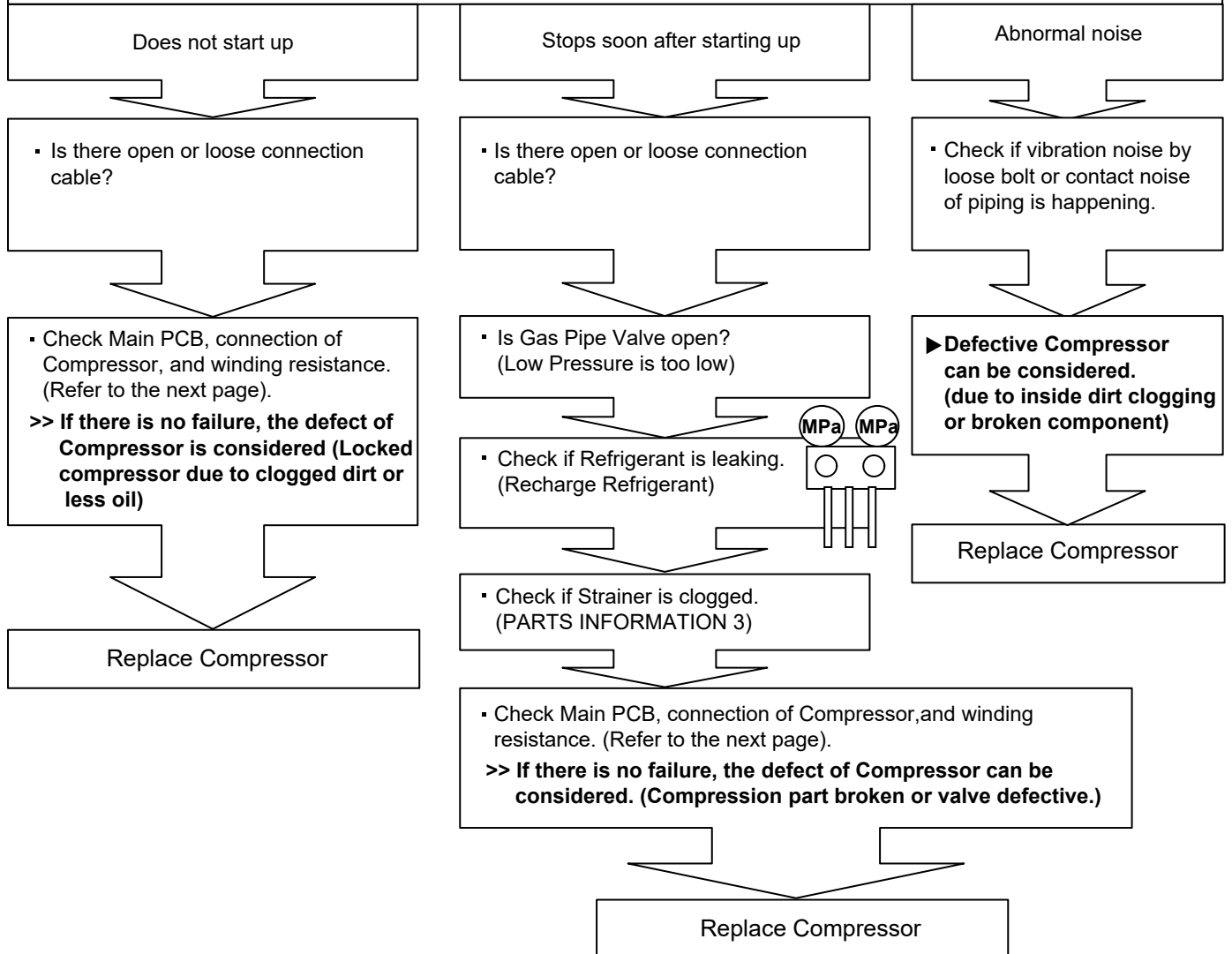

SERVICE PARTS INFORMATION 2

Inverter Compressor

Check Point 1 : Check Connection

- Check terminal connection of Compressor (loose or incorrect wiring)

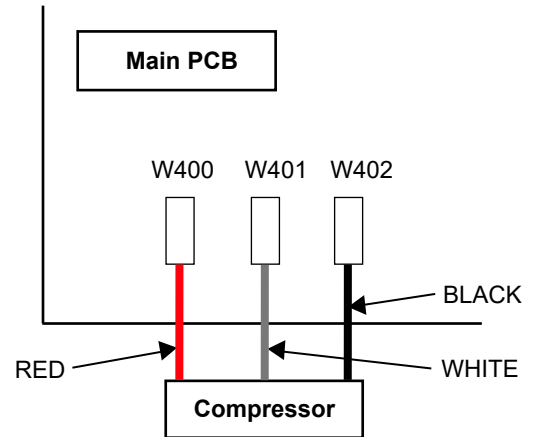
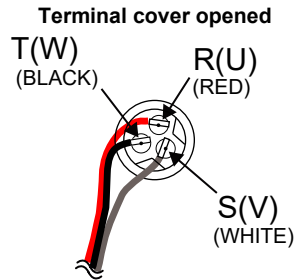
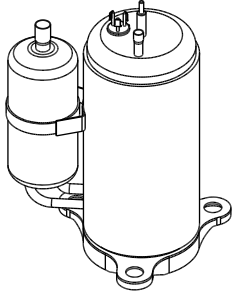

Check Point 2 : Check Winding Resistance

- Check winding resistance of each terminal
▶ **If the resistance value is 0Ω or infinite, replace Compressor.**

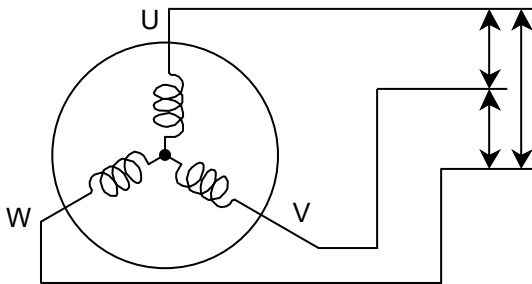

Resistance Value :
1.30 Ω at 20°C

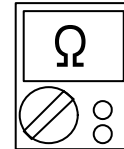

Check Point 3 : Replace Main PCB

- ▶ **If the symptom does not change with above Check 1, 2, replace Main PCB.**

SERVICE PARTS INFORMATION 3

Outdoor unit Electronic Expansion Valve (EEV)

Check Point 1 : Check Connections

- Check connection of connector (Loose connector or open cable)

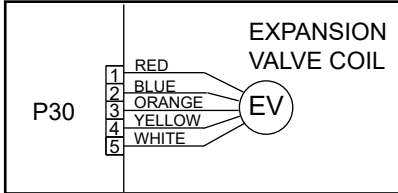

Check Point 2 : Check Coil of EEV

- Remove connector, check each winding resistance of Coil.

Read wire	Resistance value
White - Red	$46 \Omega \pm 4 \Omega$ at 20°C
Yellow - Red	
Orange - Red	
Blue - Red	

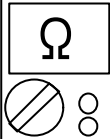

► **If Resistance value is abnormal, replace EEV.**

Check Point 3 : Check Noise at start up

- Turn on Power and check operation noise.
- **If an abnormal noise does not show, replace Main PCB.**

Check Point 4 : Check Voltage from Main PCB.

- Remove Connector and check Voltage (DC12V)
- **If it does not appear, replace Main PCB.**



Check Point 5 : Check Opening and Closing Operation of Valve

When Valve is closed, it has a temp. difference between Inlet and Outlet.

CLOSE
Example : Hot Gas

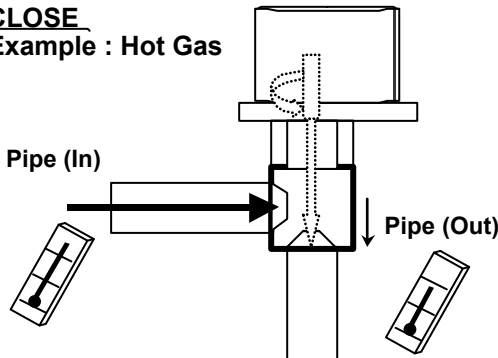

If it is open, it has no temp. difference between Inlet and Outlet.

OPEN
Example : Hot Gas

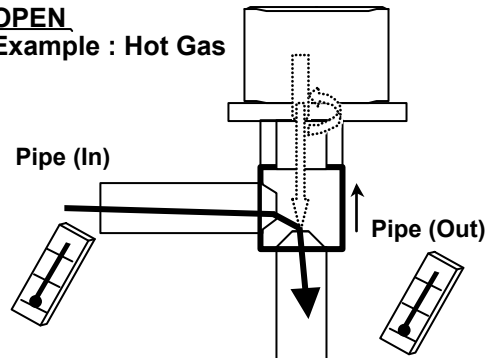

Check Point 6 : Check Strainer

Strainer normally does not have temperature difference between inlet and outlet as shown in ①, but if there is a difference as shown in ②, there is a possibility of inside clogged. In this case, replace Strainer.

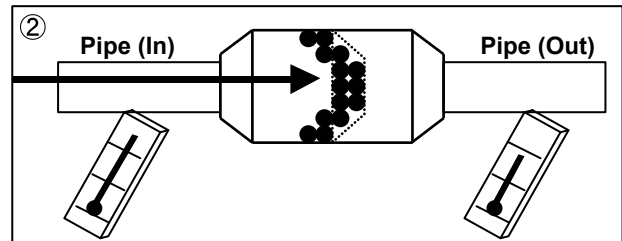
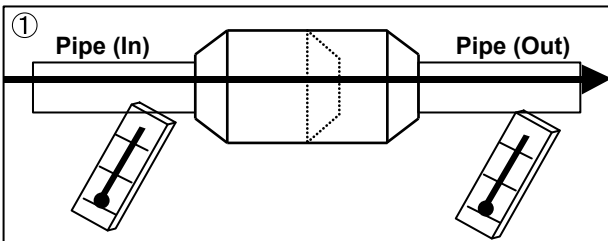

SERVICE PARTS INFORMATION 4

Indoor unit fan motor

Check Point 1 : Check rotation of Fan

- Rotate the fan by hand when operation is off.
(Check if fan is caught, dropped off or locked motor)
- >>If Fan or Bearing is abnormal, replace it.**

Check Point 2 : Check resistance of Indoor unit Fan Motor

- Refer to below. Circuit-test "Vm" and "GND" terminal.
(Vm: DC voltage, GND: Earth terminal)

>>If they are short-circuited (below 300 k Ω), replace Outdoor fan motor and Main PCB.

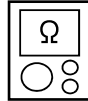

Pin number (wire color)	Terminal function (symbol)
1 (Red)	DC voltage(Vm)
2	No function
3	No function
4 (Black)	(GND)
5 (White)	Control voltage (Vcc)
6 (Yellow)	Speed command (Vsp)
7 (Brown)	Feed back (FG)

SERVICE PARTS INFORMATION 5

Outdoor unit fan motor

Check Point 1 : Check rotation of Fan

- Rotate the fan by hand when operation is off.
(Check if fan is caught, dropped off or locked motor)
- >>If Fan or Bearing is abnormal, replace it.**

Check Point 2 : Check resistance of Outdoor Fan Motor

- Refer to below. Circuit-test "Vm" and "GND" terminal.
(Vm: DC voltage, GND: Earth terminal)

>>If they are short-circuited (below 300 k Ω), replace Outdoor fan motor and Main PCB.

Pin number (wire color)	Terminal function (symbol)
1 (Red)	DC voltage (Vm)
2	No function
3	No function
4 (Black)	Earth terminal (GND)
5 (White)	Control voltage (Vcc)
6 (Yellow)	Speed command (Vsp)
7 (Brown)	Feed back (FG)

SERVICE PARTS INFORMATION 8

Thermistor

Check Point : Check Thermistor resistance value

- Remove connector and check Thermistor resistance value.

Temperature [°C]	Resistance Value [kΩ]		
	Thermistor A	Thermistor B	Thermistor C
- 20	---	---	105.4
- 10	---	27.8	58.2
- 5	---	21.0	44.0
0	168.6	16.1	33.6
5	129.8	12.4	25.9
10	100.9	9.6	20.2
15	79.1	7.6	15.8
20	62.6	6.0	12.5
25	49.8	4.8	10.0
30	40.0	3.8	8.0
40	26.3	2.5	5.3
50	17.8	1.7	3.6
60	12.3	1.2	---
70	8.7	---	---
80	6.3	---	---
90	4.6	---	---
100	3.4	---	---
110	2.6	---	---
120	2.0	---	---
Applicable Thermistors	Discharge temp. TH	Heat exchanger. TH Heat exchangr(Mid).TH	Outdoor temp. TH

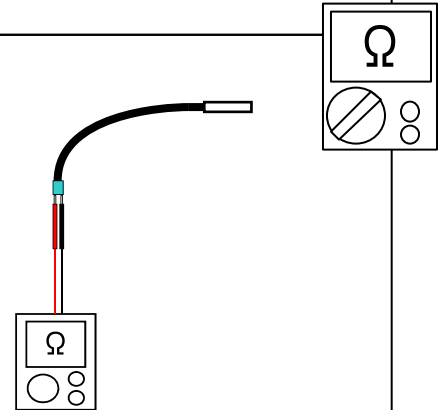

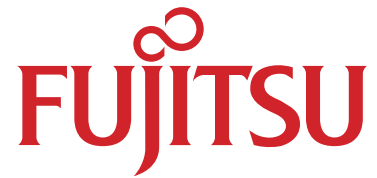

FUJITSU GENERAL LIMITED

3-3-17, Suenaga, Takatsu-ku, Kawasaki 213-8502, Japan